

DESIGNS

MS

Single impeller single stage

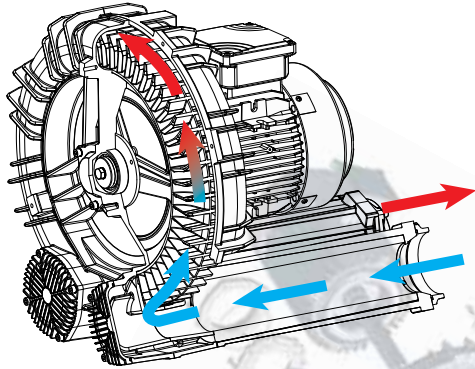

TS

Twin impeller single stage

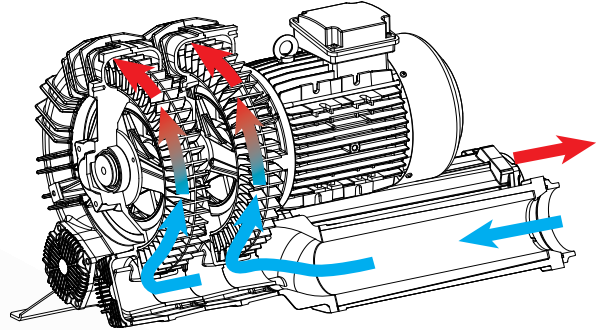

MD

Single impeller double stage

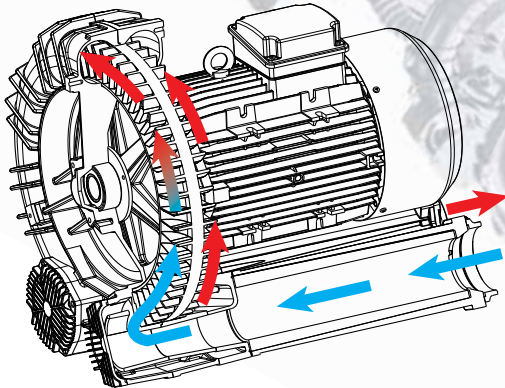

TD

Twin impeller double stage

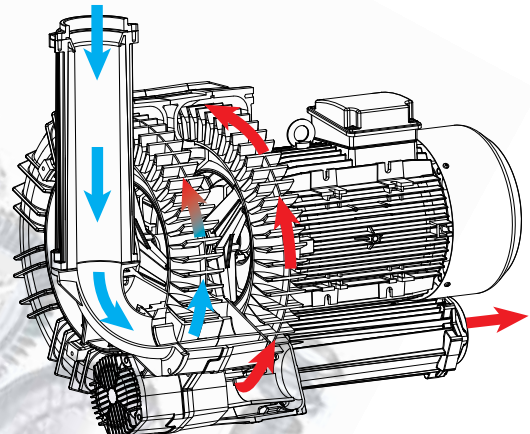

Standard Design

The standard FPZ design is a direct drive configuration, with a dynamically balanced impeller fitted directly on the motor shaft. Fitted motors are 2-pole, 1 or 3 phase, rated for continuous service. Standard motors utilize class F insulation, are suitable for use with a variable speed drive (3 phase only), and are tropicalized for corrosion resistance. Single or two stage options are pictured above.

GOR / GVR Design

"GOR / GVR" designs utilize a standard nema (or metric) electric motor that is directly coupled to the blower shaft. This direct coupled design allows the use of specialty motors that may be required to meet a variety of electrical requirements. For some models the vacuum / pressure capabilities can be increased with this GOR / GVR design (pictured right).

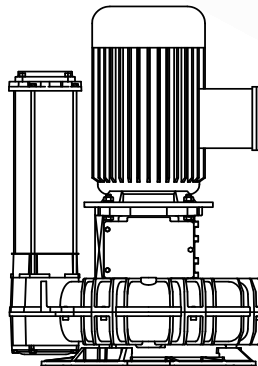

"GVR" Design

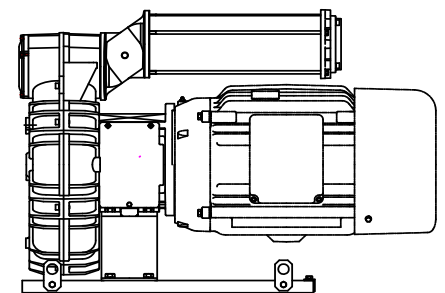

"GOR" Design

applications

APPLICATIONS

Thousands of FPZ blowers are working in a variety of applications: from commercial to industrial installations, in food processing to pharmaceuticals, from textiles to aerospace, in medical applications to environmental. Wherever efficiency and reliability are needed, FPZ responds with the appropriate product "solution"

Advantages of side channel blowers

- Compact execution
- Simple concept
- Reduced maintenance costs
- Modular design
- Pulsation and oil free air

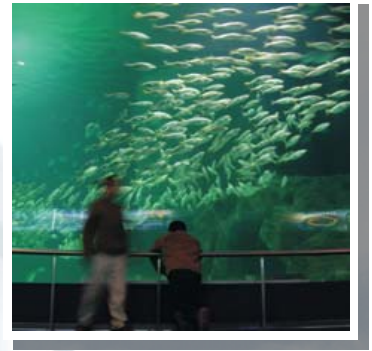
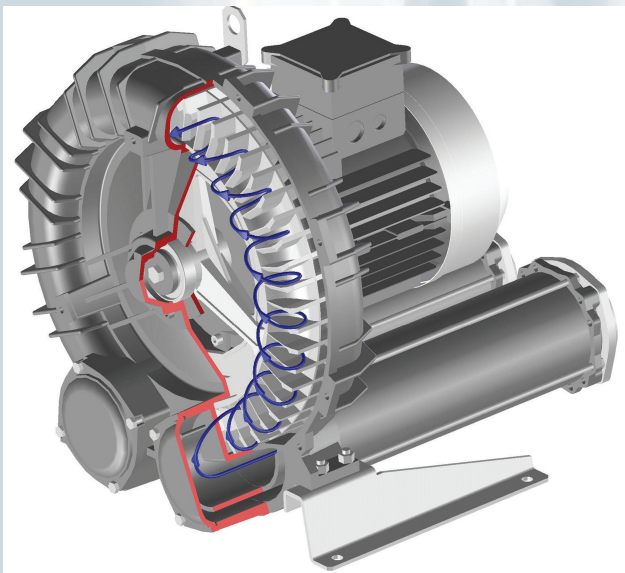

How Blowers Work

Blowers have an impeller blade mounted inside a housing. As air passes the inlet port, impeller blades draw air in and accelerate the air outward and forward. As each impeller blade strikes it, the air moves faster and faster. At the base of the housing an air stripper diverts the air out of the housing reducing the speed and then increasing the pressure.



					Page(s)	
General Pressure and Vacuum Performance Curves					4	5
K Series "MOR" Blowers - Direct Drive		Max CFM	Max Pressure (In H ₂ O)	Max Vacuum (In Hg.)	Pressure	Vacuum
SCL K03-K06 MS	Single Stage Blowers	216	132	9.6	6-7	40-41
SCL K07-K12 MS	Single Stage Blowers	726	211	11.1	8-9	42-43
SCL K05-K06 TS	Single Stage Blowers	400	85	6.3	10-11	44-45
SCL K07-K12 TS	Single Stage Blowers	1410	110	8.1	12-13	46-47
SCL K07R-12 MD	Two Stage Blowers	336	300	14.7	14-15	48-49
SCL K04-K06 TD	Two Stage Blowers	222	180	11.8	16-17	50-51
SCL K07-K12 TD	Two Stage Blowers	716	225	13.2	18-19	52-53

06 / R20-MD / DH Blowers Performance Data

SCL 06	Single Stage Blowers	39	52	3.5	20-21	54-55
SCL 10DL-15DH	Two Stage Blowers	35	120.5	8.1	22-23	56-57
SCL R20-MD; 30DH-40DH	Two Stage Blowers	98	201	11.1	24-25	58-59

K Series Direct Coupled - "GOR/GVR" configuration

SCL K03-K06 MS-GOR/GVR	Single Stage Blowers	216	140	9.6	26-27	60-61
SCL K07-K12 MS-GOR/GVR	Single Stage Blowers	726	200	10.3	28-29	62-63
SCL K05-K06 TS-GOR/GVR	Single Stage Blowers	400	130	7.8	30-31	64-65
SCL K07-K12 TS-GOR/GVR	Single Stage Blowers	1410	150	10.3	32-33	66-67
SCL K07R- K12 MD GOR/GVR	Two Stage Blowers	336	280	14.7	34-35	68-69
SCL K07-K12 TD GOR/GVR	Two Stage Blowers	716	225	13.2	36-37	70-71
SCL K09-K11 TT GOR/GVR	Three Stage Blowers	597	340	17	38-39	72-73

Values in above table based on 60 hz performance

Accessories

Installation Guide	General guide on how to install accessories.	74
VRL6-9	Safety valve selection guide	75
VRL6-9	Safety Valves	76
VRL6HP / VRL8HP	High pressure safety valves	77
CSL / CT	Filters for vacuum applications.	78
FS	Filter / Silencers for pressure applications	79
VG-020-013	Dirty Filter Indicator	80
VS 6 / VS 8	Flow Converting Devices for diverting air stream	81
VK / PK	Flange Connectors for safety valves and flexible hoses	82
CA / CK	Filter Manifolds and 90 Degree Manifold for K series blowers	83
VG / PG / CV / SS / IH	Gauges, Check Valves, Silencers, and Sound Enclosures	84
MF / TF / MP	Flexible Sleeves, Flanges, Sleeves	85

Technical

Single phase motor information	86
Three phase motor information	87
Airflow Through an Orifice	88
FPZ Pneumatic Range	89

Disclaimer

The information contained in this catalog is based on information that we believe to be correct. It is the users responsibility to determine the suitability of the product for the application they are used in and the user assumes all risk and liability whatsoever in connection therewith.



Pressure Performance Curves

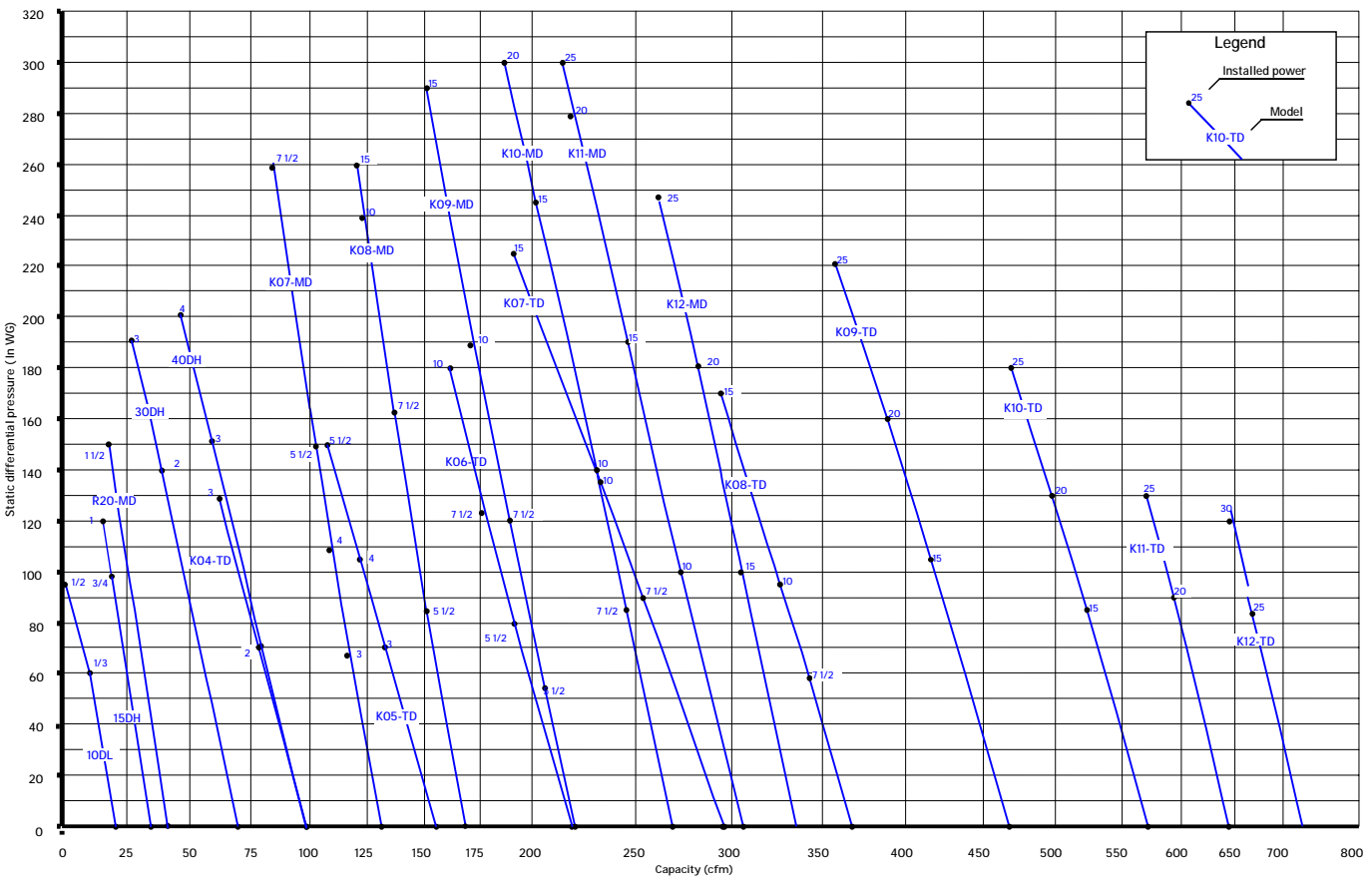
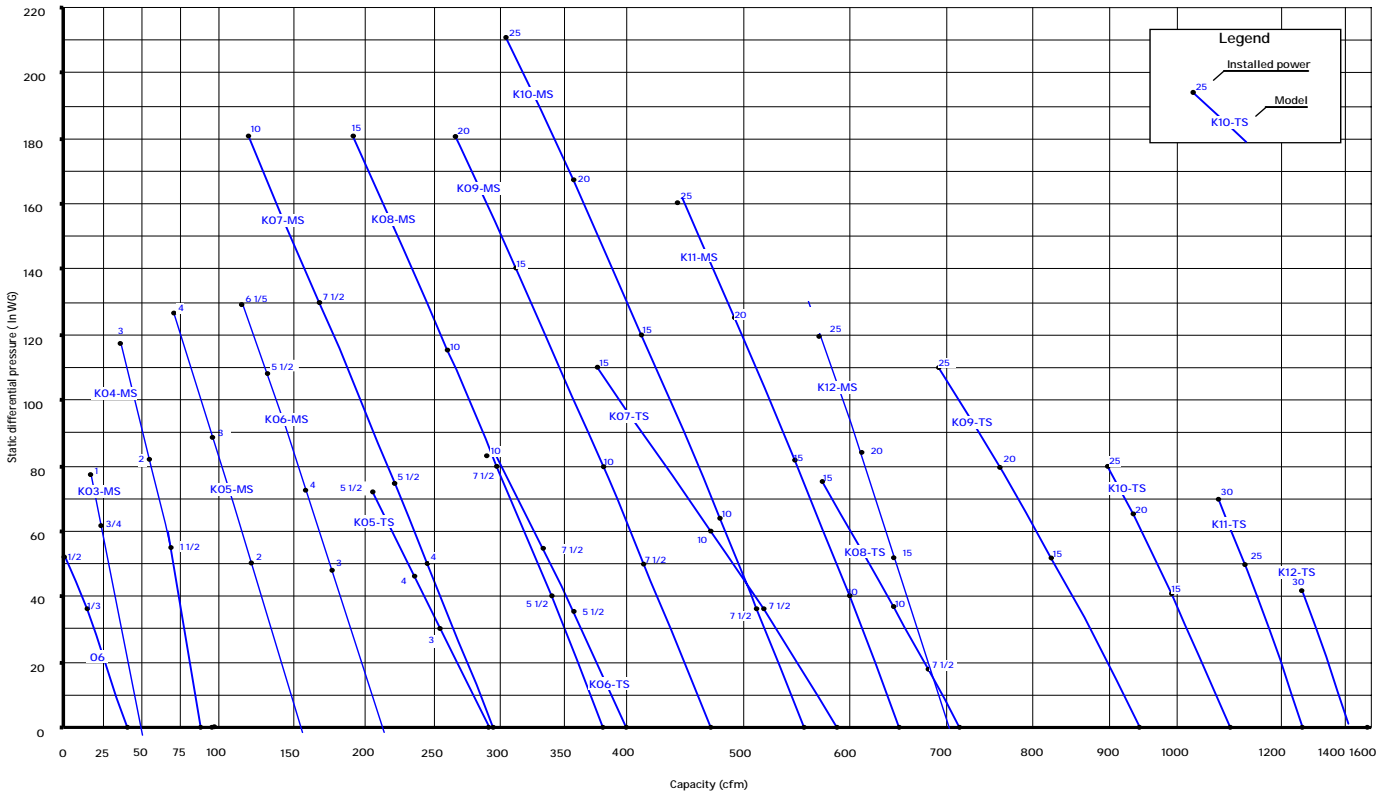

Curves refer to air at 68°F temperature and 29.92 In Hg atmospheric pressure (abs) measured at inlet port.
Tolerance on given values ± 10% - data can change without prior notice.

Vacuum Performance Curves

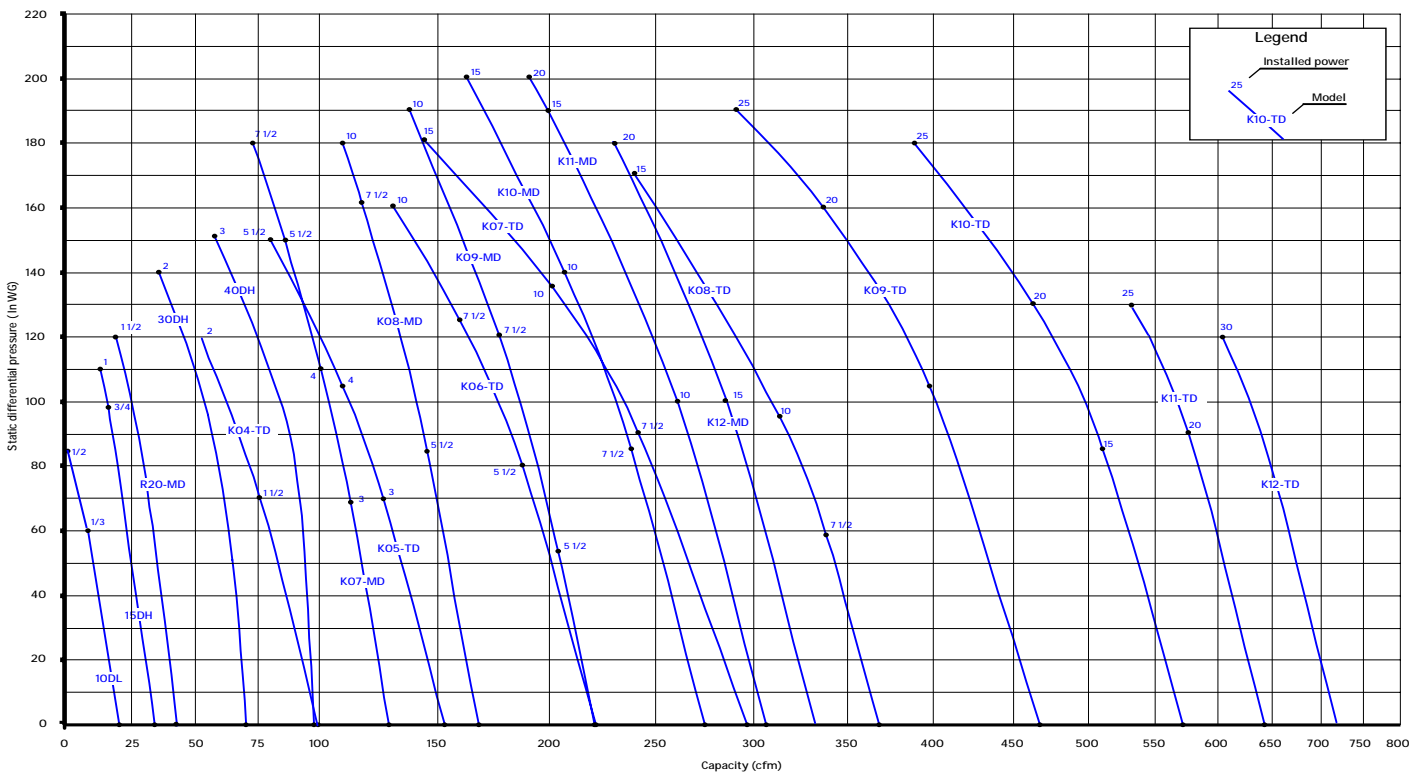
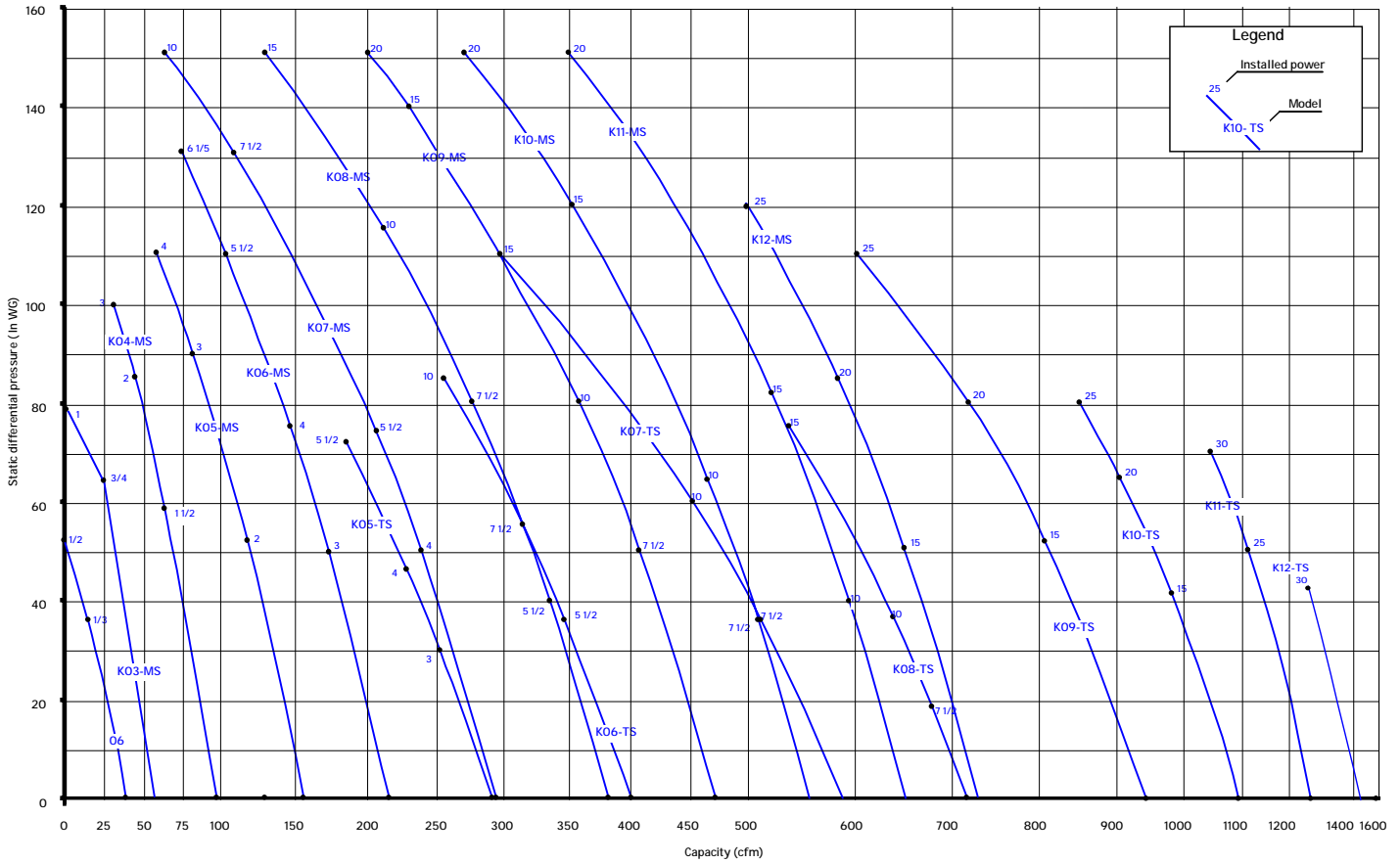

Curves refer to air at 68° F temperature, measured at inlet port and 29.92 in Hg atmospheric backpressure (abs).
Tolerance on given values ± 10% - data can change without prior notice.

TECHNICAL CHARACTERISTICS

- Aluminium alloy construction
- Smooth operation
- High efficiency impeller
- Maintenance free
- Mountable in any position
- Recognized TEFC - cURus motor

OPTIONS

- Special voltages (IEC 38)
- Surface treatments

ACCESSORIES

- Inlet and/or inline filters
- Additional inlet/outlet silencers
- Safety valves
- Flow converting device
- Optional connectors

Dimensions in inches.

Dimension for reference only.

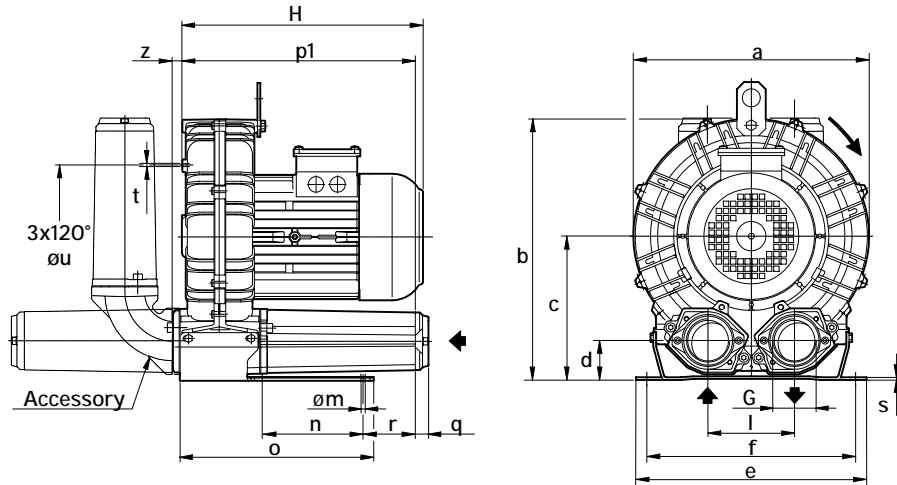

Model	a	b	c	d	e	f	G	l	m	n	o	p1	q	r	s	t	u	z
K03-MS	9.49	10.55	5.79	1.69	9.06	8.07	1 1/4 NPT	3.39	0.39	3.27	5.59	8.07	0.71	2.95	0.16	M6	5.51	0.47
K04-MS	11.22	12.40	6.77	1.93	10.04	8.86	1 1/2 NPT	4.02	0.47	3.74	6.73	8.74	0.71	2.76	0.16	M6	6.89	0.71
K05-MS	12.87	14.37	7.87	2.13	12.60	10.24	2" NPT	4.72	0.59	4.53	10.43	12.60	0.71	3.86	0.16	M8	7.87	0.75
K06-MS	14.80	15.47	8.07	2.13	12.80	11.42	2" NPT	4.92	0.59	5.51	10.71	13.15	0.71	3.35	0.16	M8	9.45	0.75

Model	Maximum flow Scfm		Installed power Hp		Maximum differential pressure Δp (In WG)		Noise level Lp dB (A) (1)		Overall dimensions H Inches	Weight Lbs
	60 Hz 3500 rpm	50 Hz 2900 rpm	60 Hz 3500 rpm	50 Hz 2900 rpm	60 Hz 3500 rpm	50 Hz 2900 rpm	60 Hz 3500 rpm	50 Hz 2900 rpm		
K03-MS	52	43	3/4	3/4	64	60	62.0	60.0	10.43	24.30
			1	1	95	77	62.3	60.3	11.97	26.50
K04-MS	98	81	1 1/2	1 1/2	58	80	64.8	62.8	11.65	36.40
			2	2	85	100	65.0	63.0	13.78	43.00
			3	-	120	-	65.2	-	13.78	49.60
K05-MS	156	129	2	2	52	70	70.5	68.5	13.20	51.80
			3	3	90	110	70.8	68.8	13.20	58.40
			4	4	128	120	71.1	69.1	14.40	67.20
K06-MS	216	179	3	3	50	65	73.0	71.0	13.54	68.70
			4	4	75	95	73.3	71.3	14.17	71.65
			5 1/2	5 1/2	110	140	73.6	71.6	14.17	77.60
			6 1/5 (2)	-	132	-	73.9	-	14.45	77.60

(1) Noise measured at 1 m distance with inlet and outlet ports piped, in accordance to ISO 3744.

(2) No cURus motor

- For proper use, the blower should be equipped with inlet filter and safety valve; other accessories available on request.
- Ambient temperature from +5° to +104°F.
- Specifications subject to change without notice.

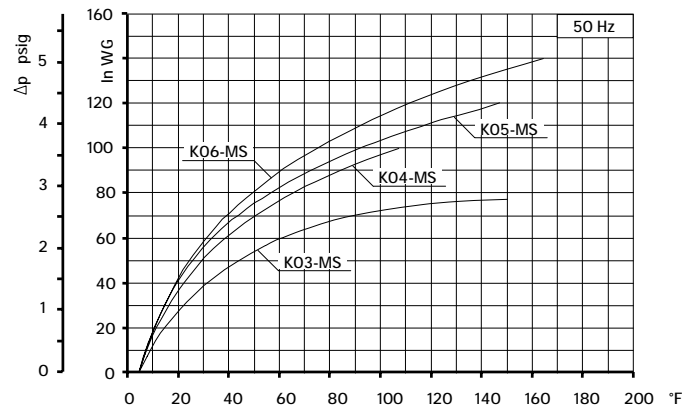
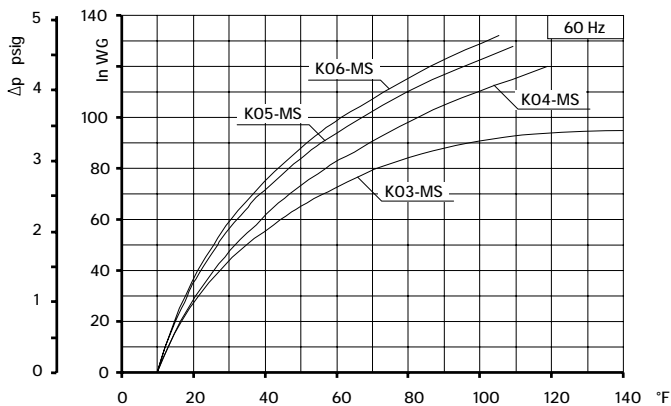
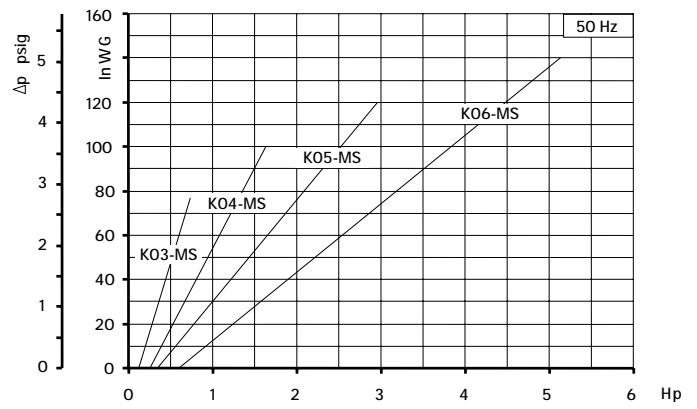
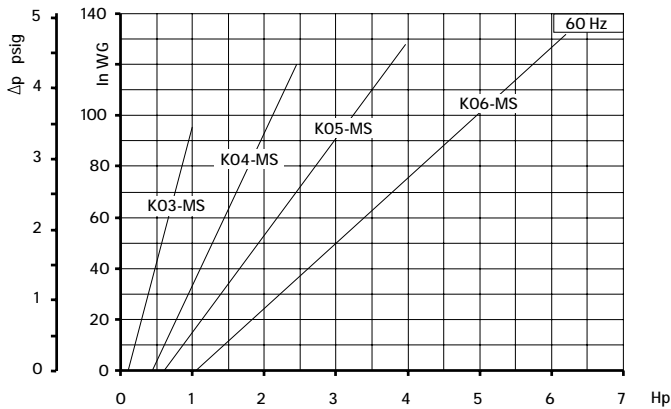
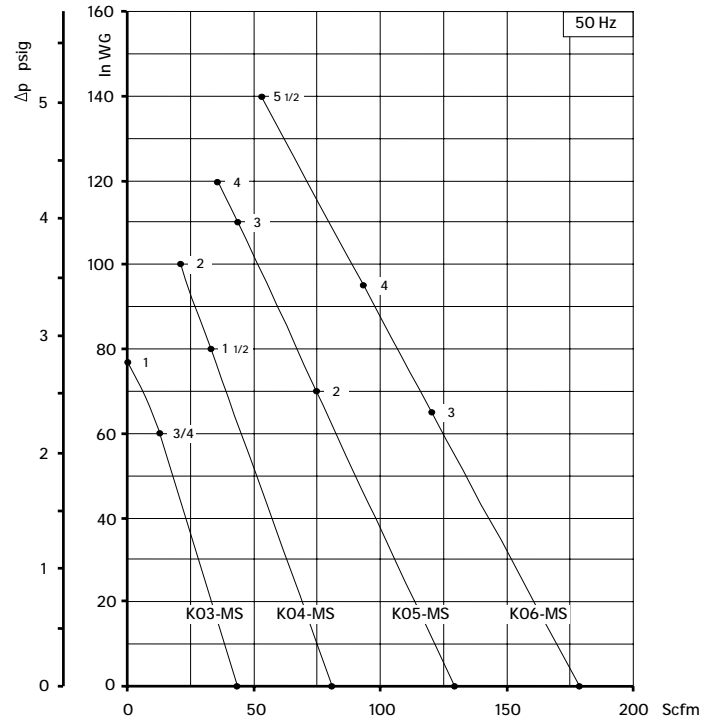
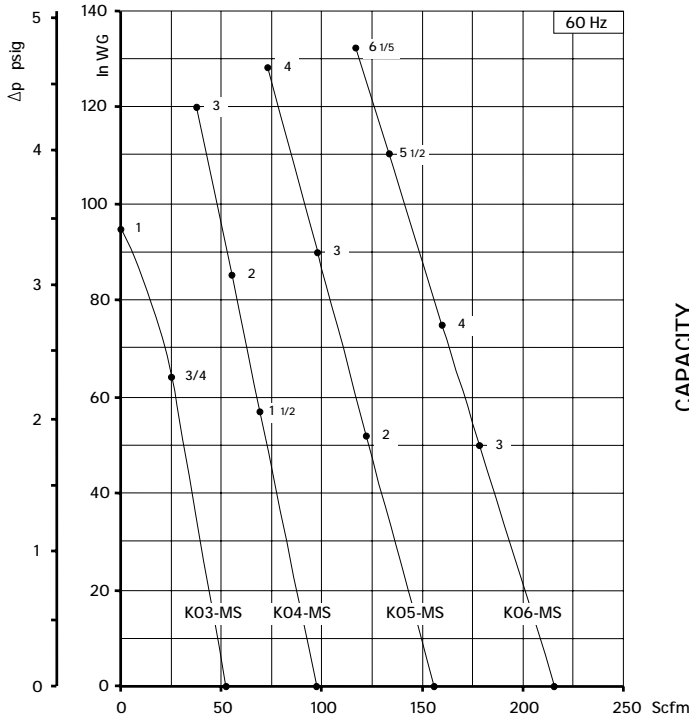

Curves refer to air at 68°F temperature and 29.92 In Hg atmospheric pressure (abs) measured at inlet port.
 Values for flow, power consumption and temperature rise: +/- 10% tolerance.
 Data subject to change without notice.

TECHNICAL CHARACTERISTICS

- Aluminium alloy construction
- Smooth operation
- High efficiency impeller
- Maintenance free
- Mountable in any position
- Recognized TEFC - cURus motor

OPTIONS

- Special voltages (IEC 38)
- Surface treatments

ACCESSORIES

- Inlet and/or inline filters
- Additional inlet/outlet silencers
- Safety valves
- Flow converting device
- Optional connectors

Dimensions in inches.

Dimension for reference only.

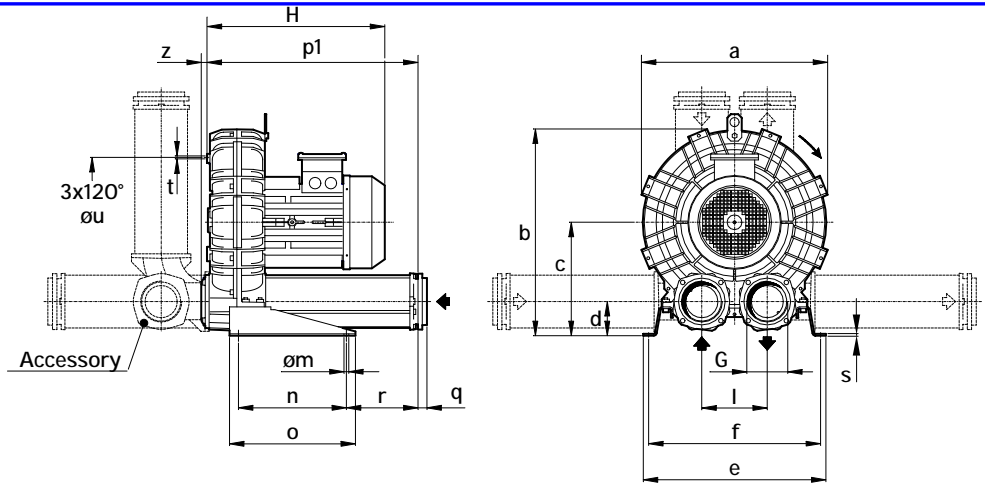

Model	a	b	c	d	e	f	G	l	m	n	o	p1	q	r	s	t	u	z
K07-MS	16.69	18.84	10.59	3.23	18.43	17.24	3" NPT	6.10	0.51	11.81	13.78	20.16	0.98	5.39	0.20	M8	11.61	0.63
K08-MS	17.99	19.61	10.59	3.23	18.82	17.64	3" NPT	6.10	0.51	11.81	13.78	20.16	0.98	5.39	0.20	M8	12.2	0.63
K09-MS	19.37	22.09	12.40	3.78	20.00	18.82	4" NPT	7.17	0.51	11.81	13.78	23.07	0.98	7.83	0.20	M8	14.17	0.63
K10-MS	20.31	22.56	12.40	3.78	20.00	18.82	4" NPT	7.17	0.51	11.81	13.78	23.07	0.98	7.83	0.20	M8	14.17	0.63
K11-MS	21.34	23.74	13.07	3.58	21.26	20.00	4" NPT	7.87	0.51	11.81	13.78	23.46	0.98	8.03	0.20	M8	15.35	0.63
K12-MS	21.57	23.82	13.07	3.58	21.26	20.00	4" NPT	7.87	0.51	11.81	13.78	23.58	0.98	8.03	0.20	M8	15.35	0.51

Model	Maximum flow Scfm		Installed power Hp		Maximum differential pressure Dp (In WG)		Noise level Lp d B (A) ⁽¹⁾		Overall dimensions H Inches	Weight Lbs
	60 Hz	50 Hz	60 Hz	50 Hz	60 Hz	50 Hz	60 Hz	50 Hz		
	3500 rpm	2900 rpm	3500 rpm	2900 rpm	3500 rpm	2900 rpm	3500 rpm	2900 rpm		
K07-MS	294	243	4	4	50	63	78.7	76.7	15.45	103.00
			5 1/2	5 1/2	75	86	79.0	77.0	15.45	107.10
			7 1/2	7 1/2	130	138	79.3	77.3	18.37	145.70
			10	10	181	161	79.6	77.6	18.37	154.50
K08-MS	381	316	5 1/2	5 1/2	40	52	79.7	77.7	15.45	115.70
			7 1/2	7 1/2	68	90	80.0	78.0	18.37	154.30
			10	10	115	125	80.3	78.3	18.37	163.10
			15	15	181	181	80.6	78.6	19.15	184.00
K09-MS	471	390	7 1/2	7 1/2	50	63	80.2	78.2	18.84	166.50
			10	10	80	95	80.5	78.5	18.84	175.10
			15	15	140	155	81.0	79.0	19.63	196.20
			20	20	181	181	81.3	79.3	23.74	269.00
K10-MS	556	460	7 1/2	7 1/2	36	51	80.1	78.1	18.84	170.90
			10	10	64	80	80.5	78.5	18.84	179.50
			15	15	120	135	81.0	79.0	19.63	200.60
			20	20	167	191	81.4	79.4	23.74	273.40
			25	25	211	201	81.6	79.6	24.61	298.70
K11-MS	650	539	10	10	40	53	82.0	80.0	19.04	194.90
			15	15	82	97	82.4	80.4	19.83	216.00
			20	20	125	141	82.7	80.7	23.94	288.80
			25	25	162	201	85.6	83.6	24.81	313.10
K12-MS	726	602	15	15	52	90	82.9	80.9	19.95	223.70
			20	20	85	130	83.2	81.2	24.06	296.50
			25	25	140	160	86.1	84.1	24.92	320.80

(1) Noise measured at 1 m distance with inlet and outlet ports piped, in accordance to ISO 3744.

- For proper use, the blower should be equipped with inlet filter and safety valve; other accessories available on request.
- Ambient temperature from +5° to +104°F.
- Specifications subject to change without notice.

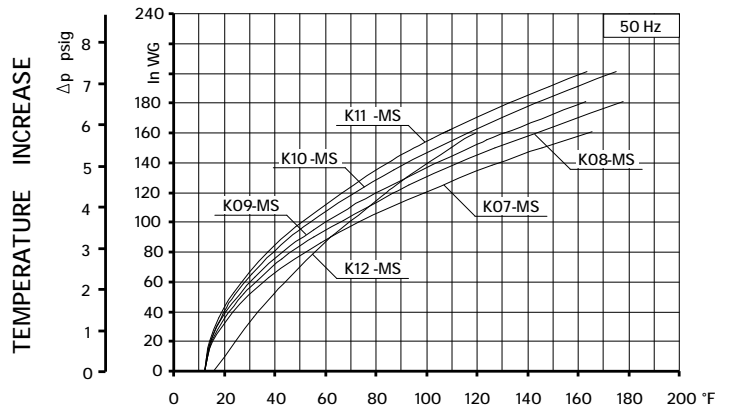
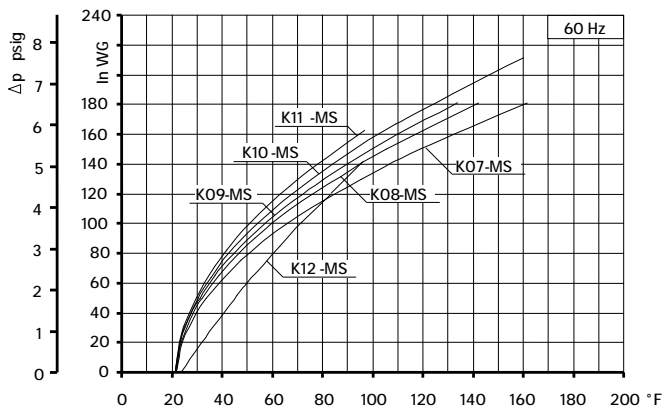
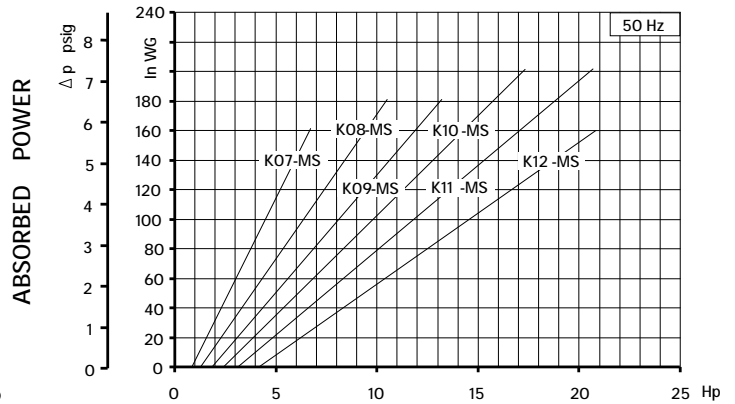
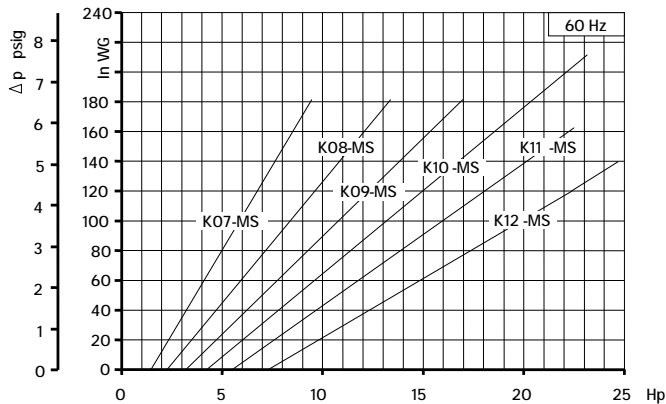
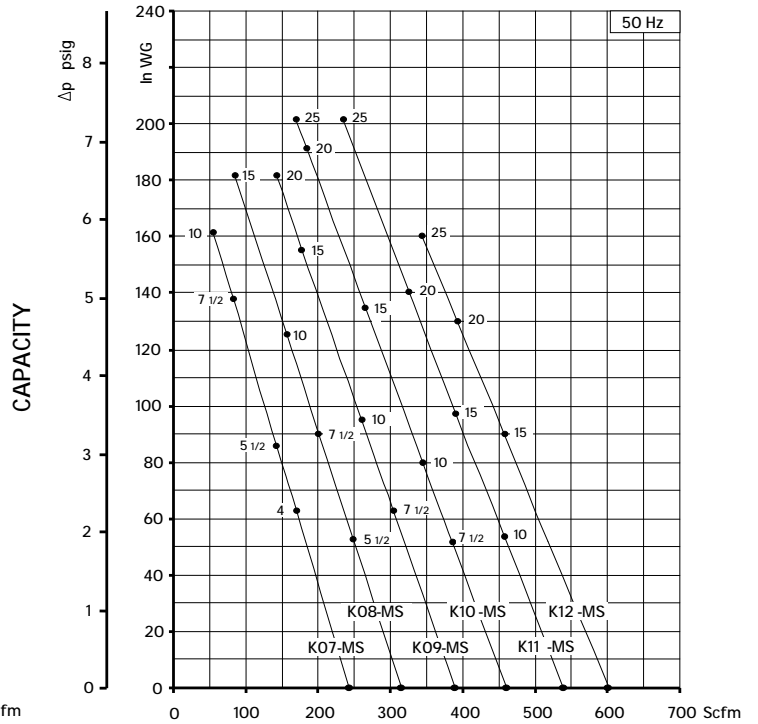
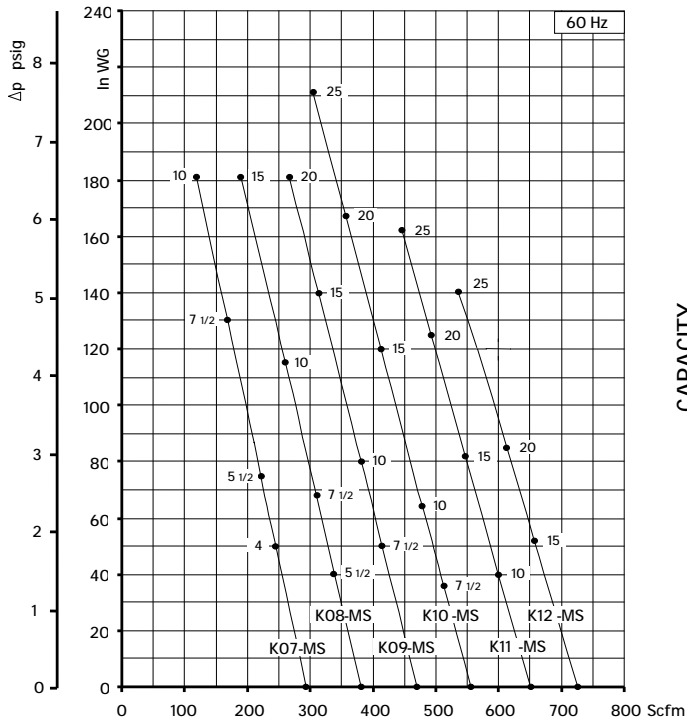

Curves refer to air at 68°F temperature and 29.92 In Hg atmospheric pressure (abs) measured at inlet port.
Values for flow, power consumption and temperature rise: +/- 10% tolerance.
Data subject to change without notice.

TECHNICAL CHARACTERISTICS

- Aluminium alloy construction
- Smooth operation
- High efficiency impeller
- Maintenance free
- Mountable in any position
- Recognized TEFC - cURus motor 3x120°øu

OPTIONS

- Special voltages (IEC 38)
- Surface treatments

ACCESSORIES

- Inlet and/or inline filters
- Additional inlet/outlet silencers
- Safety valves
- Flow converting device
- Optional connectors

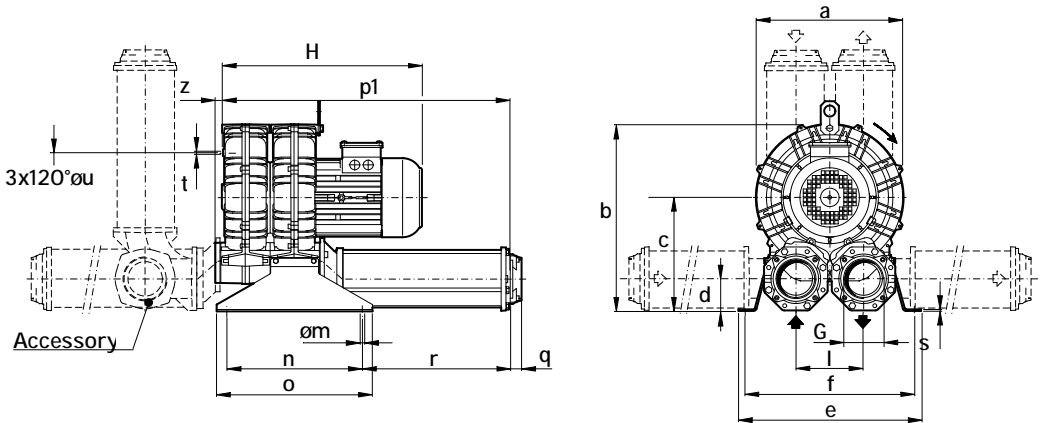

Dimensions in inches.

Dimension for reference only.

Model	a	b	c	d	e	f	G	l	m	n	o	p1	q	r	s	t	u	z
K05-TS	12.87	16.61	10.16	3.03	15.91	14.72	3" NPT	5.91	0.51	11.81	13.58	24.96	0.98	12.91	0.16	M8	7.87	0.75
K06-TS	14.80	17.72	10.31	2.95	15.91	14.72	3" NPT	6.10	0.51	11.81	13.58	26.06	0.98	13.19	0.16	M8	9.45	0.75

Model	Maximum flow Scfm		Installed power Hp		Maximum differential pressure Δp (In WG)		Noise level Lp dB (A) (1)		Overall dimensions H Inches	Weight Lbs
	60 Hz 3500 rpm	50 Hz 2900 rpm	60 Hz 3500 rpm	50 Hz 2900 rpm	60 Hz 3500 rpm	50 Hz 2900 rpm	60 Hz 3500 rpm	50 Hz 2900 rpm		
K05-TS	290	241	3	3	30	45	72.0	70.0	17.45	85.98
			4	4	46	70	73.5	71.5	18.64	89.29
			5 1/2	5 1/2	72	100	75.5	73.5	18.64	93.70
K06-TS	400	331	5 1/2	5 1/2	36	55	77.2	75.2	18.98	104.72
			7 1/2	7 1/2	55	65	77.5	75.5	22.60	141.09
			10	10	85	93	77.8	75.8	22.60	149.91

(1) Noise measured at 1 m distance with inlet and outlet ports piped, in accordance to ISO 3744.

- For proper use, the blower should be equipped with inlet filter and safety valve; other accessories available on request.
- Ambient temperature from +5° to +104°F.
- Specifications subject to change without notice.

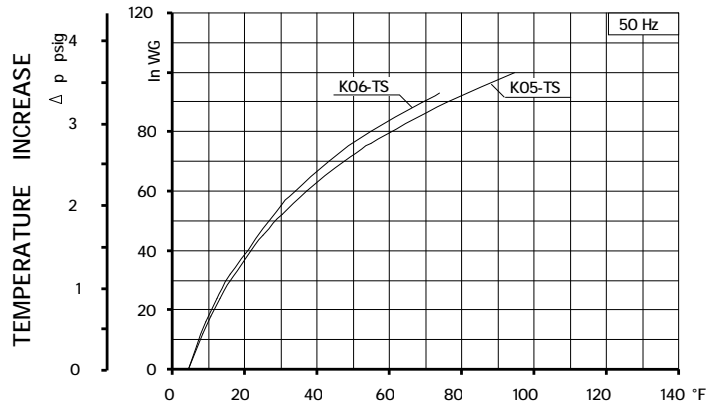
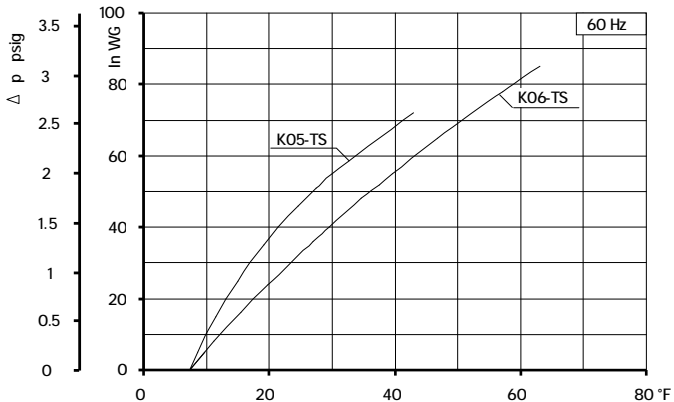
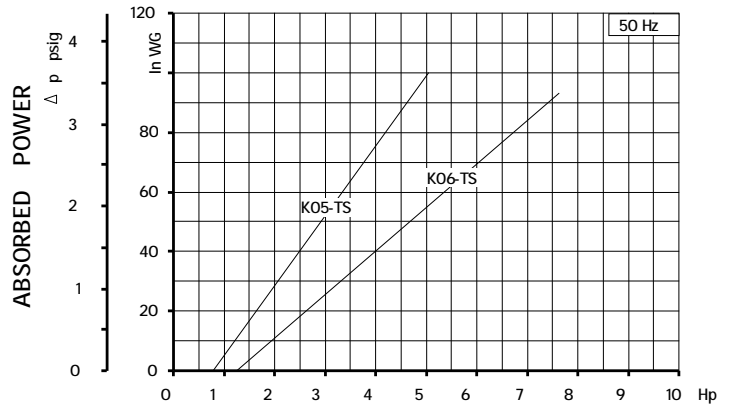
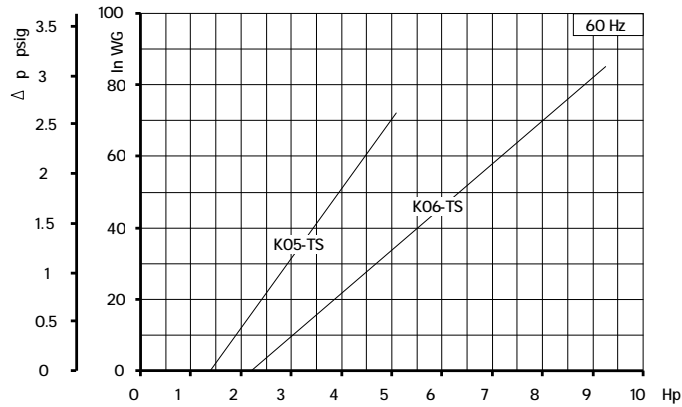
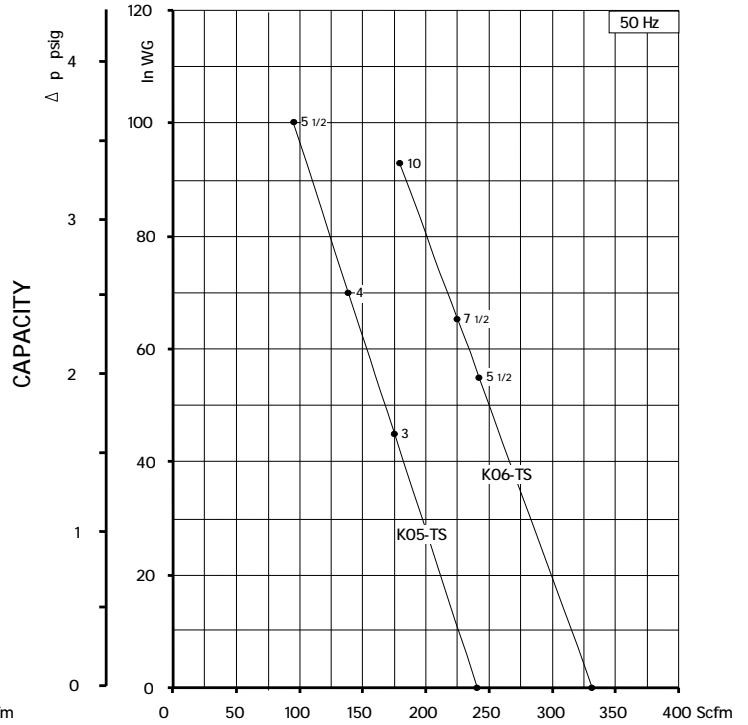
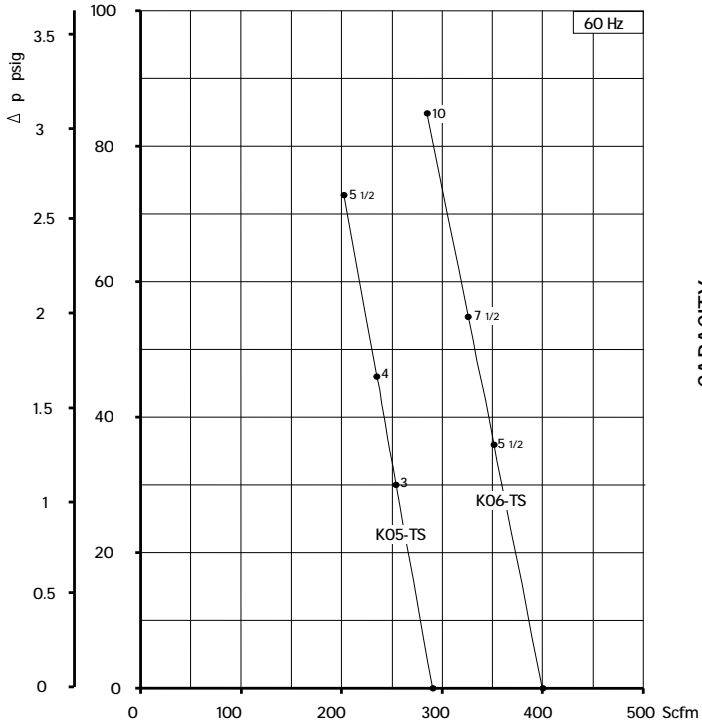

Curves refer to air at 68°F temperature and 29.92 In Hg atmospheric pressure (abs) measured at inlet port.
 Values for flow, power consumption and temperature rise: +/-10% tolerance.
 Data subject to change without notice.

TECHNICAL CHARACTERISTICS

- Aluminium alloy construction
- Smooth operation
- High efficiency impeller
- Maintenance free
- Mountable in any position
- Recognized TEFC - cURus motor
- G1/8" female thread on both suction and discharge silencer port flanges

OPTIONS

- Special voltages (IEC 38)
- Surface treatments

ACCESSORIES

- Inlet and/or inline filters
- Additional inlet/outlet silencers
- Safety valves
- Flow converting device
- Optional connectors

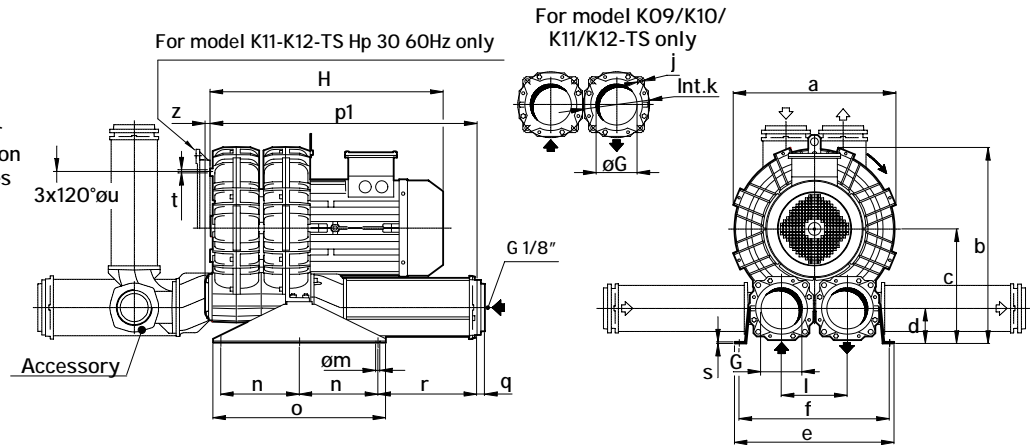

Dimensions in inches.

Dimension for reference only.

Model	a	b	c	d	e	f	G	l	j	k	m	n	o	p1	q	r	s	t	u	z
K07-TS	16.69	20.91	12.56	3.86	18.43	17.24	4"NPT	7.17	-	-	0.51	9.84	21.65	31.57	0.98	11.77	0.20	M8	11.61	0.63
K08-TS	18.03	21.57	12.56	3.86	18.82	17.64	4"NPT	7.17	-	-	0.51	9.84	21.65	31.57	0.98	11.77	0.20	M8	12.20	0.63
K09-TS	19.37	24.02	14.37	4.41	20.00	18.82	5.12	8.27	M16	8.27	0.51	9.84	21.65	33.46	-	12.40	0.20	M8	14.17	0.63
K10-TS	20.31	24.53	14.37	4.41	20.00	18.82	5.12	8.27	M16	8.27	0.51	9.84	21.65	33.46	-	12.40	0.20	M8	14.17	0.63
K11-TS	21.26	25.59	14.96	4.17	21.26	20.08	5.12	8.98	M16	8.27	0.51	9.84	21.65	34.25	-	12.60	0.20	M8	15.35	0.63
K12-TS	21.57	25.66	14.96	4.17	21.26	20.08	5.12	8.98	M16	8.27	0.51	9.84	21.65	34.37	-	12.60	0.20	M8	15.35	0.63

Model	Maximum flow Scfm		Installed power Hp		Maximum differential pressure Δp (In WG)		Noise level Lp dB (A) (1)		Overall dimensions H Inches	Weight Lbs
	60 Hz 3500 rpm	50 Hz 2900 rpm	60 Hz 3500 rpm	50 Hz 2900 rpm	60 Hz 3500 rpm	50 Hz 2900 rpm	60 Hz 3500 rpm	50 Hz 2900 rpm		
K07-TS	588	487	7 1/2	7 1/2	36	48	83.9	81.9	23.76	197.31
			10	10	60	71	84.2	82.2	23.76	206.13
			15	15	110	121	84.8	82.8	24.55	223.77
K08-TS	715	592	7 1/2	7 1/2	18	30	80.8	78.8	23.76	205.47
			10	10	37	50	80.9	78.9	23.76	214.29
			15	15	75	87	83.3	81.3	24.55	231.92
K09-TS	941	780	20	20	80	90	85.0	83.0	29.92	350.53
			25	25	110	120	87.0	85.0	30.79	383.60
K10-TS	1093	906	20	20	65	75	88.1	86.1	29.92	354.94
			25	25	80	95	88.4	86.4	30.79	388.01
K11-TS	1254	1039	25	25	50	69	89.4	87.4	31.38	429.02
			30 ⁽²⁾	30 ⁽²⁾	70	90	90.0	88.0	31.38	434.53
K12-TS	1410	1168	30 ⁽²⁾	30 ⁽²⁾	45	80	90.6	88.6	31.50	436.75

(1) Noise measured at 1 m distance with inlet and outlet ports piped, in accordance to ISO 3744.

(2) K11-K12-TS Hp 30 vertical assembly only.

- For proper use, the blower should be equipped with inlet filter and safety valve; other accessories available on request.
- Ambient temperature from +5° to +104°F.
- Specifications subject to change without notice.

SCL K07 / K08 / K09 / K10 / K11 / K12

TS SERIES

SN 1822-12

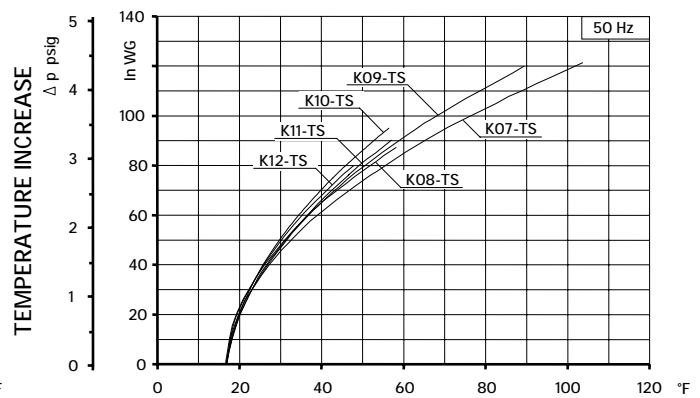
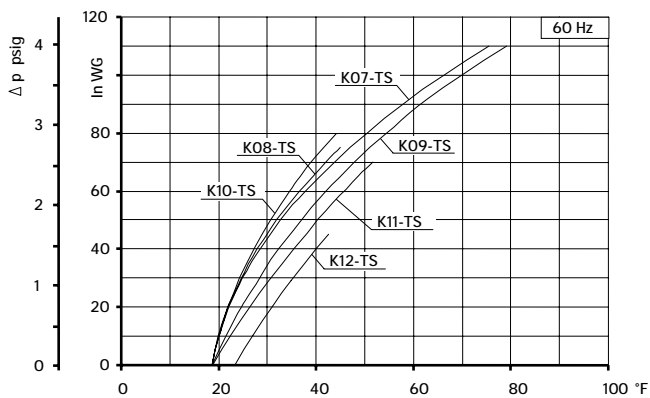
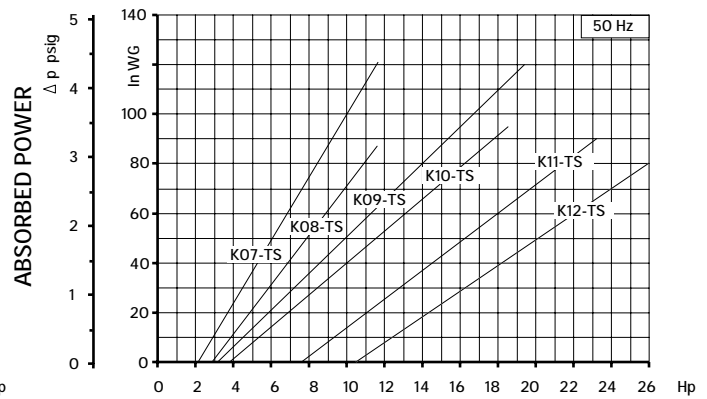
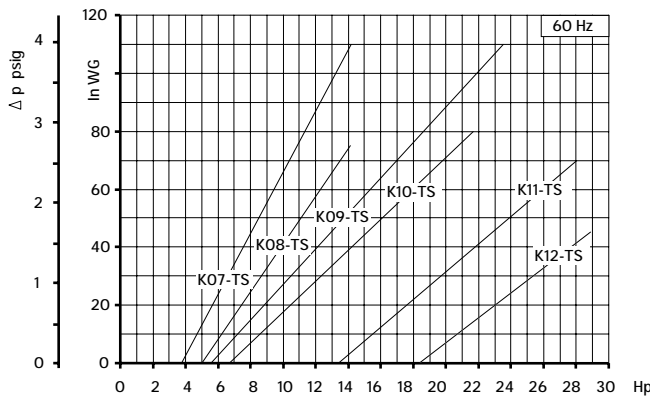
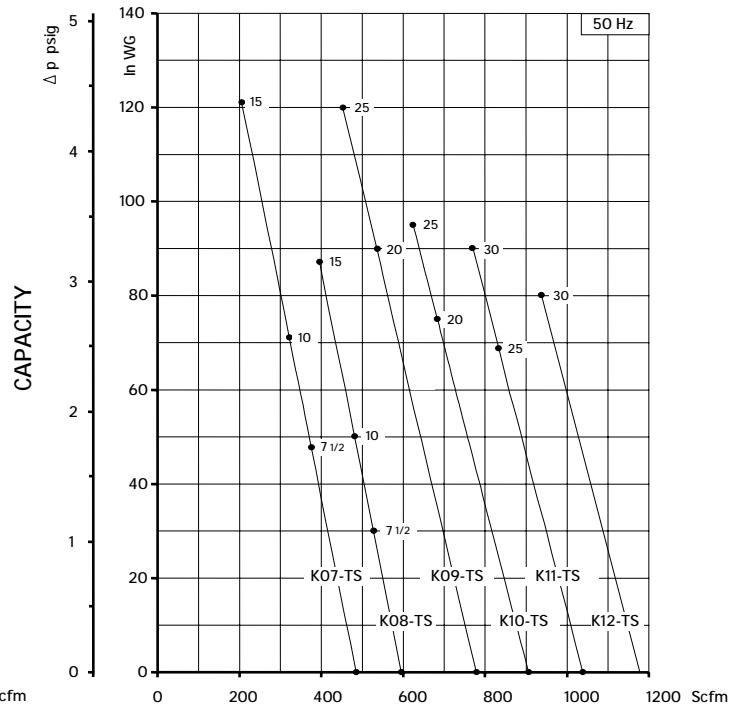
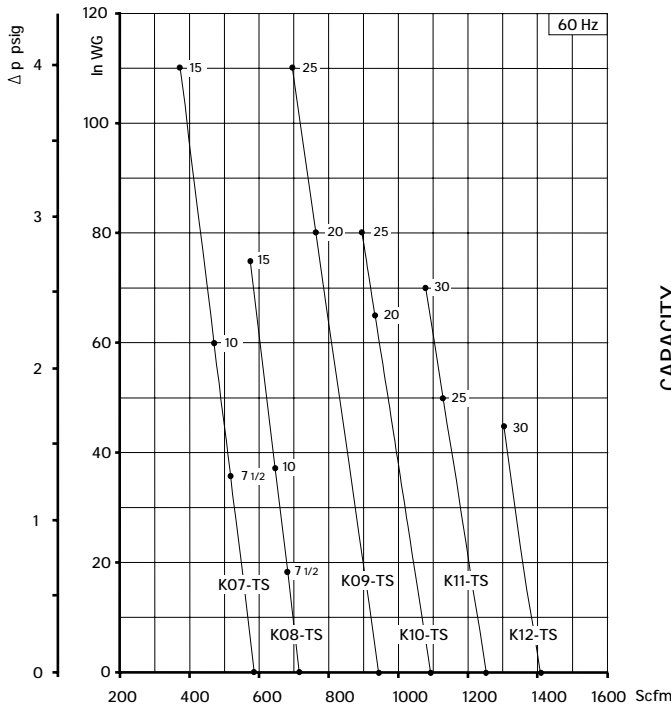

Curves refer to air at 68°F temperature and 29.92 In Hg atmospheric pressure (abs) measured at inlet port.
Values for flow, power consumption and temperature rise: +/-10% tolerance.
Data subject to change without notice.

TECHNICAL CHARACTERISTICS

- Aluminium alloy construction
- Smooth operation
- High efficiency impeller
- Maintenance free
- Mountable in any position
- Recognized TEFC - cURus motor

OPTIONS

- Special voltages (IEC 38)
- Surface treatments

ACCESSORIES

- Inlet and/or inline filters
- Additional inlet/outlet silencers
- Safety valves
- Flow converting device
- Optional connectors

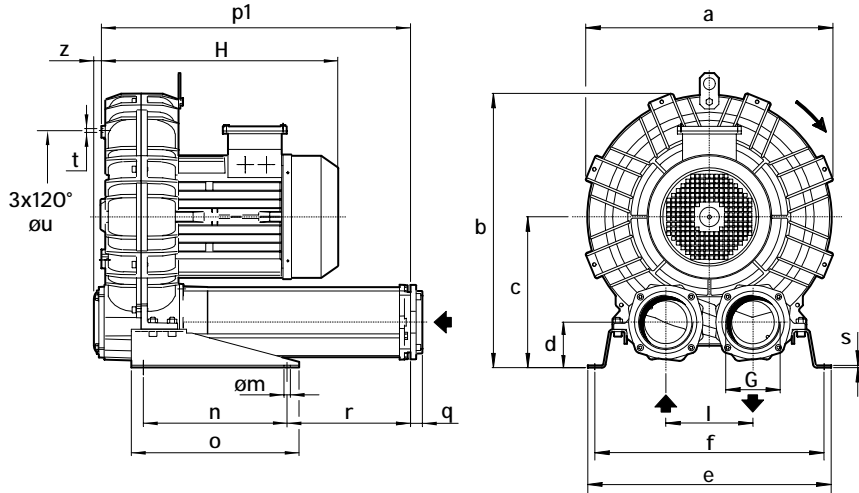

Dimensions in inches.
Dimension for reference only.

Model	a	b	c	d	e	f	G	l	m	n	o	p1	q	r	s	t	u	z
K07R-MD	16.69	18.94	10.59	3.23	18.43	17.24	2" NPT	6.10	0.51	11.81	3.78	16.46	0.71	1.70	0.20	M8	11.61	0.63
K08R-MD	17.99	19.61	10.59	3.23	18.82	17.64	2" NPT	6.10	0.51	11.81	13.78	16.46	0.71	1.70	0.20	M8	12.20	0.63
K09-MD	19.37	22.09	12.40	3.78	20.00	18.82	4" NPT	7.17	0.51	11.81	13.78	25.35	0.98	10.12	0.20	M8	14.17	0.63
K10-MD	20.31	22.56	12.40	3.78	20.00	18.82	4" NPT	7.17	0.51	11.81	13.78	25.35	0.98	10.12	0.20	M8	14.17	0.63
K11-MD	21.35	23.74	13.07	3.58	21.18	20.00	4" NPT	7.87	0.51	11.81	13.78	25.75	0.98	10.31	0.20	M8	15.35	0.63
K12-MD	21.57	23.85	13.07	3.58	21.18	20.00	4" NPT	7.87	0.51	11.81	13.78	25.87	0.98	10.31	Ø0	M8	15.35	0.62

Model	Maximum flow Scfm		Installed power Hp		Maximum differential pressure Δp (In WG)		Noise level Lp dB (A) ⁽¹⁾		Overall dimensions H Inches	Weight Lbs
	60 Hz 3500 rpm	50 Hz 2900 rpm	60 Hz 3500 rpm	50 Hz 2900 rpm	60 Hz 3500 rpm	50 Hz 2900 rpm	60 Hz 3500 rpm	50 Hz 2900 rpm		
	K07R-MD	129	107	3	3	68	87	73.5	71.5	16.14
4	4			110	128	74.0	72.0	16.14	103.60	
5 1/2	5 1/2			150	170	74.5	72.5	16.14	111.50	
7 1/2	7 1/2			260	260	75.0	73.0	17.52	134.50	
K08R-MD	168	139	5 1/2	5 1/2	85	110	76.2	74.2	16.14	116.90
7 1/2			7 1/2	162	185	76.6	74.6	17.52	140.00	
10			10	240	260	77.0	75.0	17.52	151.00	
15			-	260	-	77.3	-	17.52	173.00	
K09-MD	221	183	5 1/2	5 1/2	54	78	76.9	74.9	16.54	144.40
7 1/2			7 1/2	120	143	78.0	76.0	17.95	167.60	
10			10	190	210	79.5	77.5	17.95	178.60	
15			15	290	290	80.5	78.5	19.29	200.60	
K10-MD	275	228	7 1/2	7 1/2	85	110	79.9	77.9	17.91	170.90
10			10	140	165	80.3	78.3	17.91	181.90	
15			15	245	270	81.4	79.4	19.29	203.90	
20			20	300	300	81.7	79.7	22.97	270.00	
K11-MD	306	254	10	10	100	125	81.1	79.1	18.11	211.60
15			15	190	220	81.4	79.4	19.49	232.60	
20			20	280	300	81.7	79.7	23.23	287.20	
25			-	300	-	82.0	-	23.23	353.30	
K12-MD	336	278	15	15	100	180	82.3	80.3	19.61	240.30
20			20	180	260	82.6	80.6	23.42	295.00	
25			-	250	-	82.9	-	23.42	361.00	

(1) Noise measured at 1 m distance with inlet and outlet ports piped, in accordance to ISO 3744.

- For proper use, the blower should be equipped with inlet filter and safety valve; other accessories available on request.
- Ambient temperature from +5° to +104°F.
- Specifications subject to change without notice.

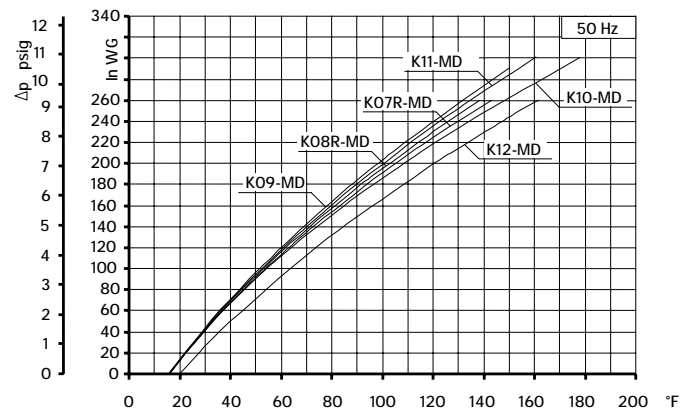
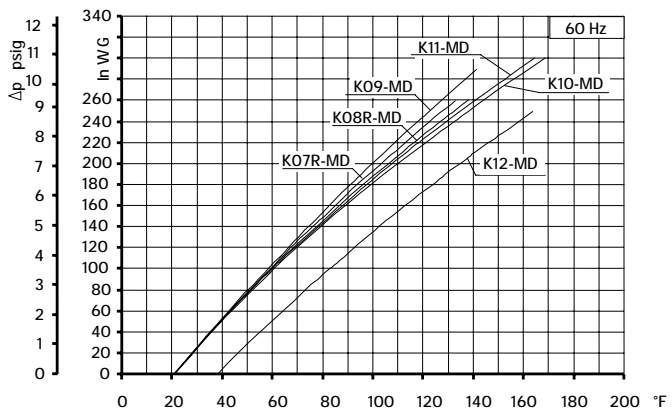
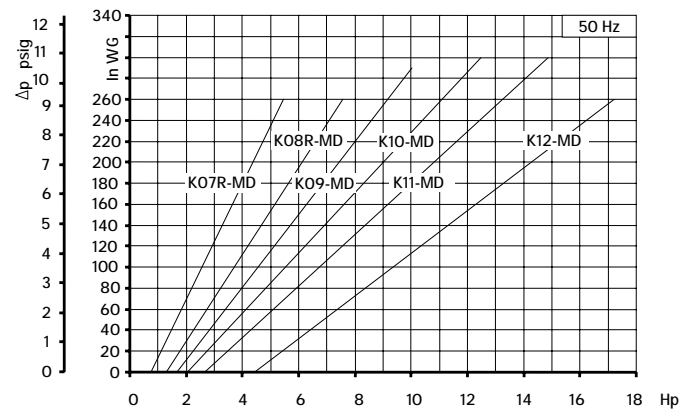
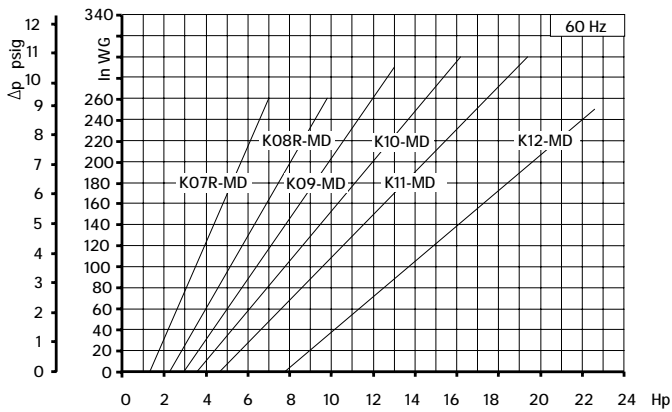
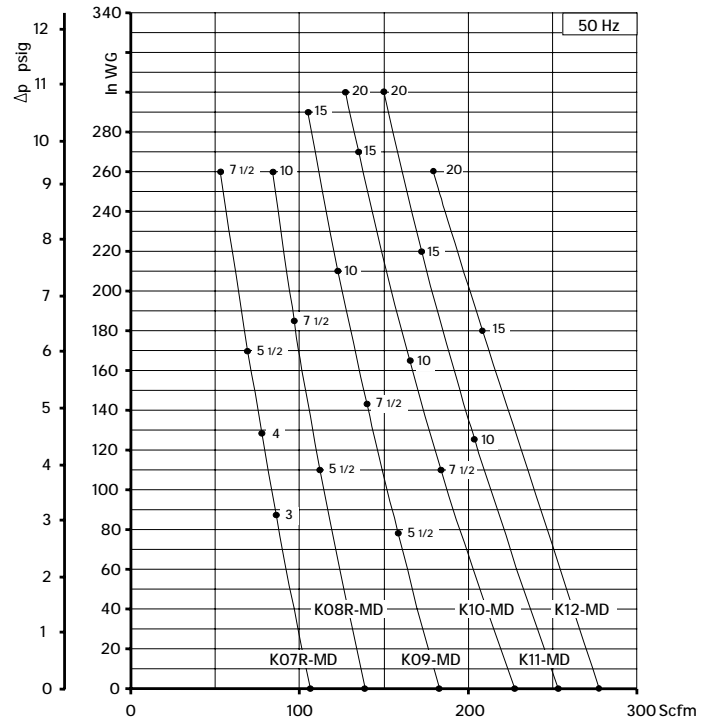
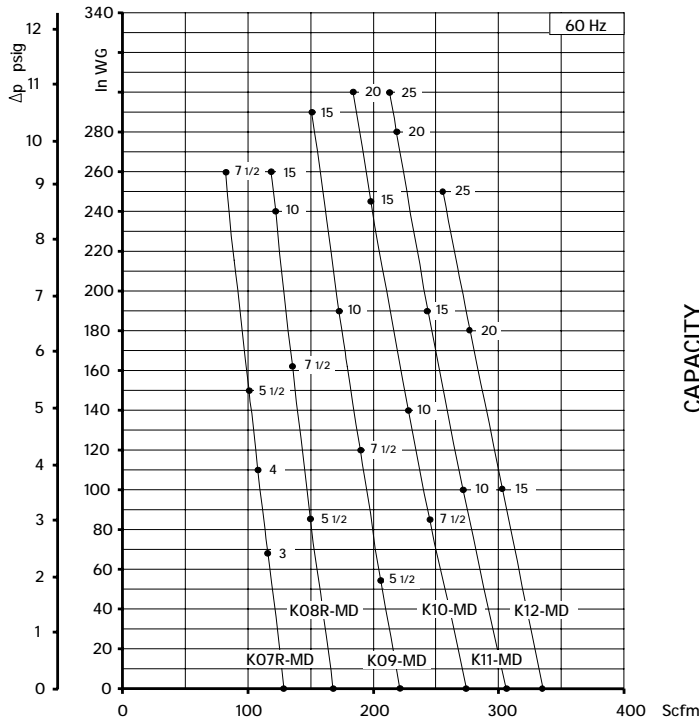

Curves refer to air at 68°F temperature and 29.92 In Hg atmospheric pressure (abs) measured at inlet port.
 Values for flow, power consumption and temperature rise: +/-10% tolerance.
 Data subject to change without notice.

TECHNICAL CHARACTERISTICS

- Aluminium alloy construction
- Smooth operation
- High efficiency impeller
- Maintenance free
- Mountable in any position
- Recognized TEFC - cURus motor

OPTIONS

- Special voltages (IEC 38)
- Surface treatments

ACCESSORIES

- Inlet and/or inline filters
- Additional inlet/outlet silencers
- Safety valves
- Flow converting device
- Optional connectors

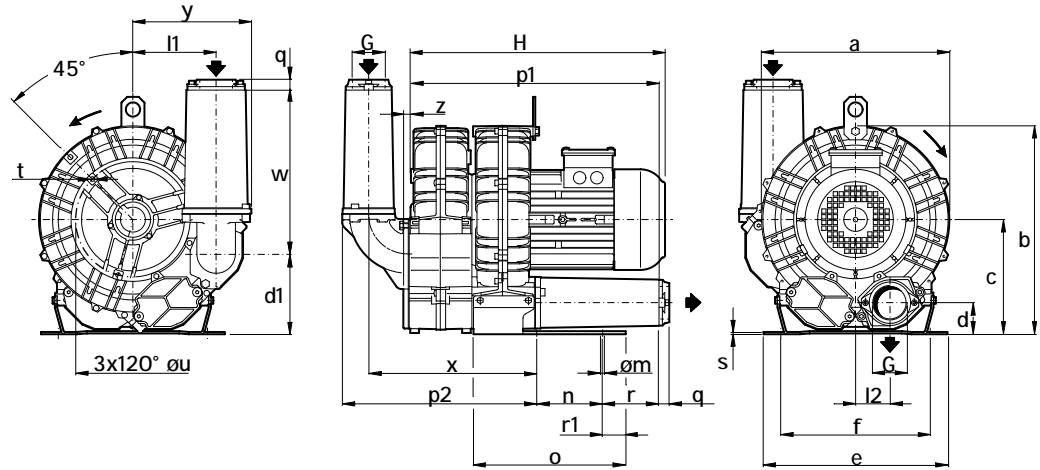

Dimensions in inches.
Dimension for reference only.

Model	a	b	c	d	d1	e	f	G	l1	l2	m	n	o	p1	p2	q	r	r1	s	t	u	w	x	y	z
K04-TD	11.22	12.40	6.77	1.93	4.76	10.04	8.86	1" 1/2 NPT	4.84	2.01	0.47	3.74	6.73	12.44	10.00	0.71	2.76	0.59	0.16	M6	6.89	7.40	8.43	6.81	0.71
K05-TD	12.87	14.37	7.87	2.13	5.51	12.60	10.24	2" NPT	5.71	2.36	0.59	4.53	10.43	16.85	13.39	0.71	3.86	1.57	0.16	M8	7.87	11.26	11.54	8.11	0.75
K06-TD	14.80	16.54	9.13	2.32	6.69	12.80	11.42	2" NPT	5.94	2.87	0.59	5.51	10.43	19.92	13.94	0.71	5.35	0.75	0.16	M8	9.45	11.26	12.13	8.27	0.75

Model	Maximum flow Scfm		Installed power Hp		Maximum differential pressure Δp (In WG)		Noise level Lp dB (A) ⁽¹⁾		Overall dimensions H Inches	Weight Lbs
	60 Hz 3500 rpm	50 Hz 2900 rpm	60 Hz 3500 rpm	50 Hz 2900 rpm	60 Hz 3500 rpm	50 Hz 2900 rpm	60 Hz 3500 rpm	50 Hz 2900 rpm		
	K04-TD	99	82	2	2	70	95	71.0	69.0	17.26
K05-TD	153	127	3	3	130	160	72.0	70.0	17.26	69.44
			3	3	70	95	73.0	71.0	17.45	84.88
			4	4	105	135	74.5	72.5	18.64	88.18
K06-TD	222	184	5 1/2	5 1/2	150	190	76.0	74.0	18.64	92.59
			5 1/2	5 1/2	80	120	75.0	73.0	18.98	103.62
			7 1/2	7 1/2	125	140	76.0	74.0	22.60	139.99
			10	10	180	200	77.0	75.0	22.60	148.81

(1) Noise measured at 1 m distance with inlet and outlet ports piped, in accordance to ISO 3744.

- For proper use, the blower should be equipped with inlet filter and safety valve; other accessories available on request.
- Ambient temperature from +5° to +104°F.
- Specifications subject to change without notice.

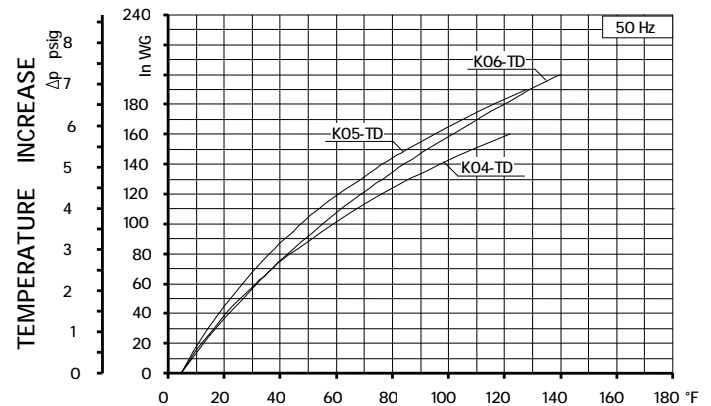
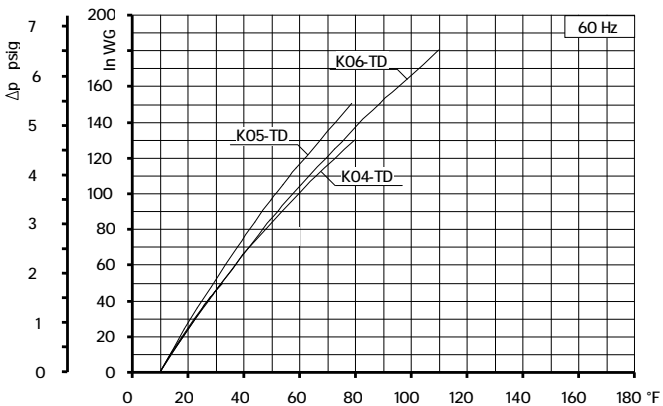
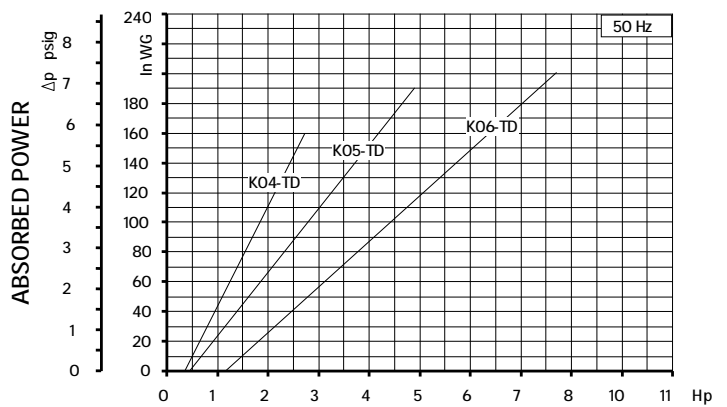
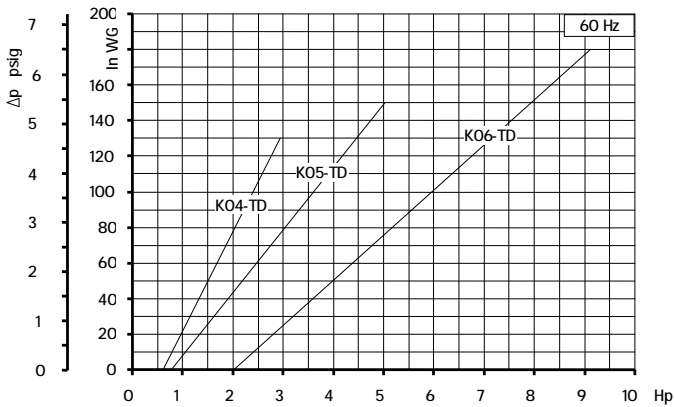
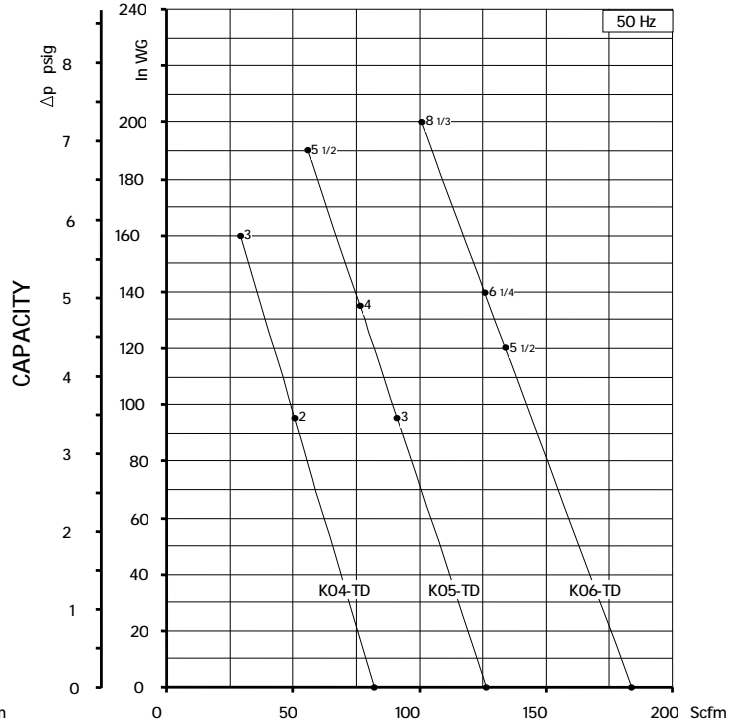
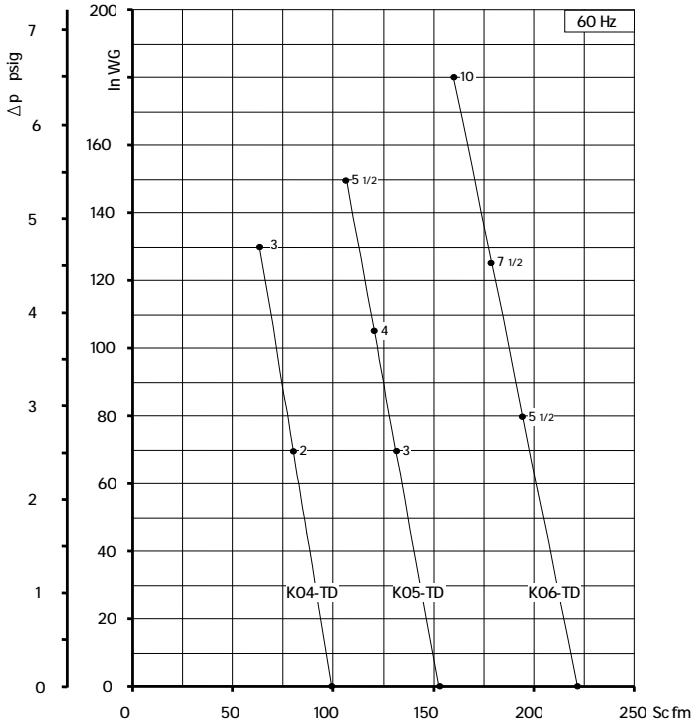

Curves refer to air at 68°F temperature and 29.92 In Hg atmospheric pressure (abs) measured at inlet port.
 Values for flow, power consumption and temperature rise +/-10% tolerance.
 Data subject to change without notice.

TECHNICAL CHARACTERISTICS

- Aluminium alloy construction
- Smooth operation
- High efficiency impeller
- Maintenance free
- Mountable in any position
- Recognized TEFC - cURus motor
- G1/8" female thread on both suction and discharge silencer port flanges

OPTIONS

- Special voltages (IEC 38)
- Surface treatments

ACCESSORIES

- Inlet and/or inline filters
- Additional inlet/outlet silencers
- Safety valves
- Flow converting device
- Optional connectors

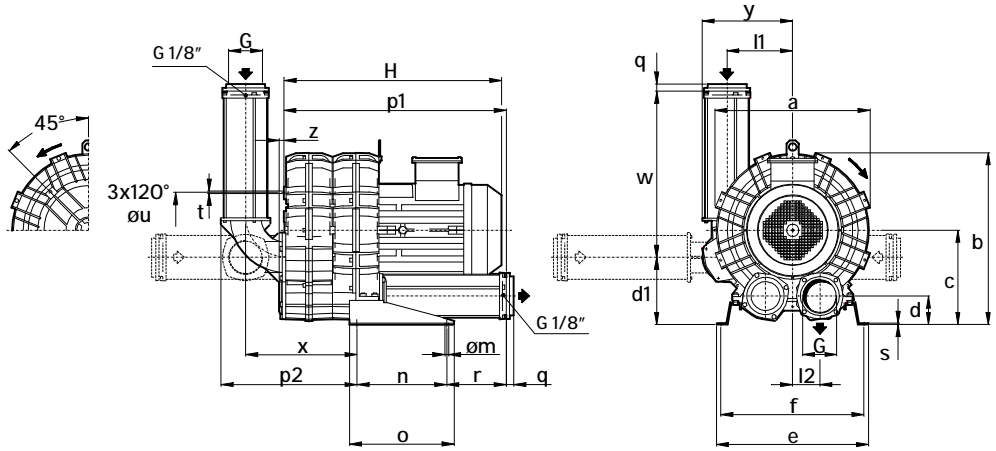

Dimensions in inches.
 Dimension for reference only.

Model	a	b	c	d	d1	e	f	G	l1	l2	m	n	o	p1	p2	q	r	s	t	u	w	x	y	z
K07-TD	16.69	18.94	10.59	3.23	7.56	18.43	17.24	3"NPT	7.36	3.05	0.51	11.81	13.78	25.55	15.43	0.98	5.39	0.20	M8	11.61	18.94	12.56	10.24	0.63
K08-TD	17.99	19.61	10.59	3.23	7.56	18.82	17.64	3"NPT	7.36	3.05	0.51	11.81	13.78	25.55	15.43	0.98	5.39	0.20	M8	12.20	18.94	12.56	10.24	0.63
K09-TD	19.37	22.09	12.4	3.78	8.86	20.00	18.82	4"NPT	8.66	3.58	0.51	11.81	13.78	29.33	17.91	0.98	7.83	0.20	M8	14.17	21.89	14.65	11.89	0.63
K10-TD	20.31	22.56	12.4	3.78	8.86	20.00	18.82	4"NPT	8.66	3.58	0.51	11.81	13.78	29.33	17.91	0.98	7.83	0.20	M8	14.17	21.89	14.65	11.89	0.63
K11-TD	21.26	23.70	13.07	3.54	9.13	21.18	20.00	4"NPT	9.53	3.94	0.51	11.81	13.78	30.12	18.50	0.98	8.03	0.20	M8	15.35	21.89	15.24	12.76	0.63
K12-TD	21.57	23.81	13.07	3.54	9.13	21.18	20.00	4"NPT	9.53	3.94	0.51	11.81	13.78	30.23	18.50	0.98	8.03	0.20	M8	15.35	21.89	15.24	12.76	0.63

Model	Maximum flow Scfm		Installed power Hp		Maximum differential pressure Δp (In WG)		Noise level Lp dB (A) ⁽¹⁾		Overall dimensions H Inches	Weight Lbs
	60 Hz 3500 rpm	50 Hz 2900 rpm	60 Hz 3500 rpm	50 Hz 2900 rpm	60 Hz 3500 rpm	50 Hz 2900 rpm	60 Hz 3500 rpm	50 Hz 2900 rpm		
			7 1/2	7 1/2	90	105	80.9	78.9	23.76	194.0
K07-TD	296	245	10	10	135	150	81.2	79.2	23.76	202.8
			15	15	225	241	81.8	79.8	24.55	220.5
			7 1/2	7 1/2	58	75	80.1	78.1	23.76	202.16
K08-TD	368	305	10	10	95	110	80.4	78.4	23.76	210.98
			15	15	170	185	81.5	79.5	24.55	228.62
			15	15	105	125	82.7	80.7	25.81	222.66
K09-TD	467	387	20	20	160	180	83.0	81.0	29.92	347.22
			25	25	220	240	83.3	81.3	30.79	380.29
			15	15	85	100	86.6	84.6	25.81	271.17
K10-TD	571	473	20	20	130	150	86.9	84.9	29.92	351.63
			25	25	180	200	87.2	85.2	30.79	384.70
			20	20	90	115	87.4	85.4	31.38	392.64
K11-TD	642	532	25	25	130	155	87.9	85.9	31.38	425.71
			25	25	85	140	88.2	86.2	31.50	423.50
K12-TD	716	593	30	30	120	190	88.7	86.7	31.50	429.0

(1) Noise measured at 1 m distance with inlet and outlet ports piped, in accordance to ISO 3744.

- For proper use, the blower should be equipped with inlet filter and safety valve; other accessories available on request.
- Ambient temperature from +5° to +104°F.
- Specifications subject to change without notice.

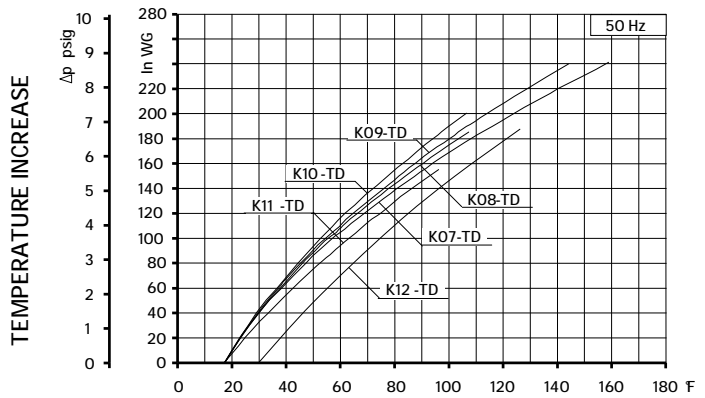
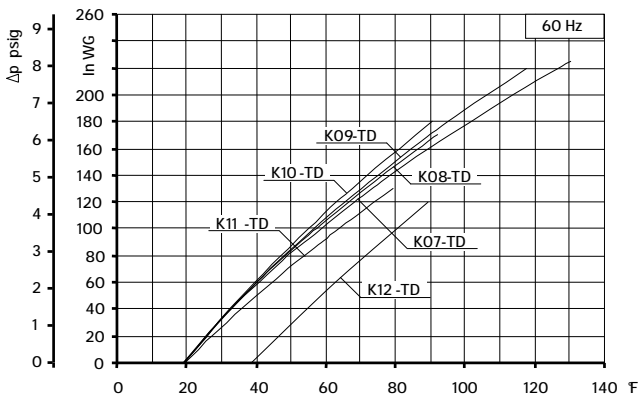
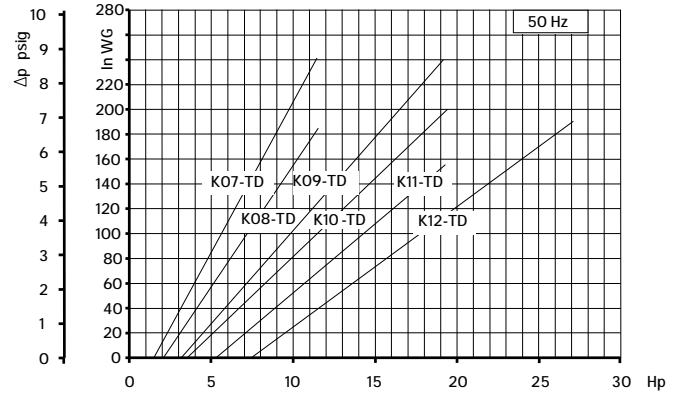
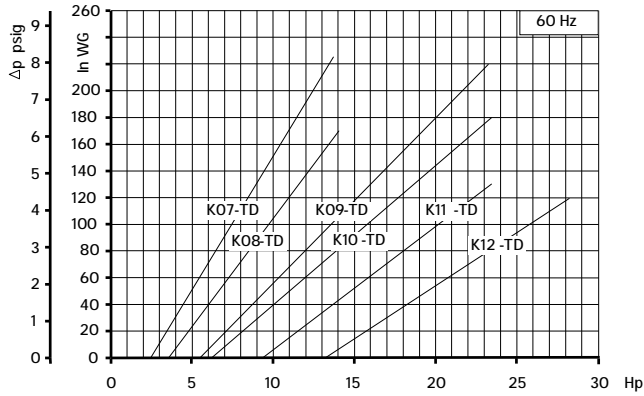
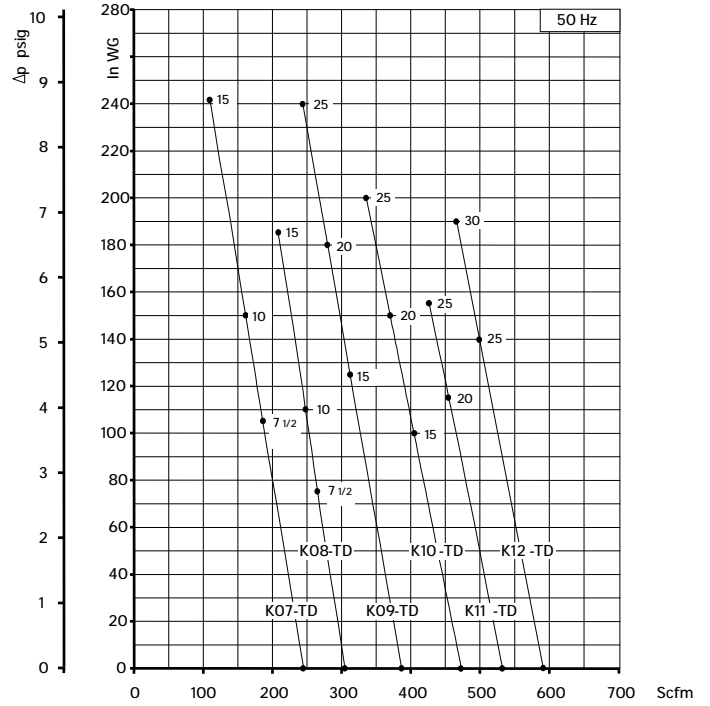
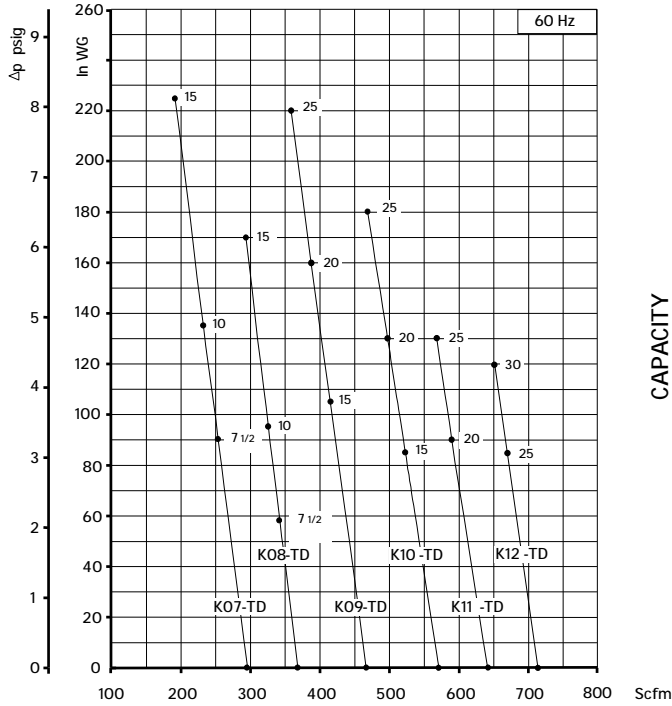

Curves refer to air at 68°F temperature and 29.92 In Hg atmospheric pressure (abs) measured at inlet port.
 Values for flow, power consumption and temperature rise: +/-10% tolerance.
 Data subject to change without notice.

STANDARD FEATURES

- Low weight cast aluminum construction.
- Quiet operation with integral inlet and outlet muffling.
- Recognized TEFC - cURus motor.
- High efficiency / low noise impeller design.
- No lubrication / maintenance required.
- Allowed ambient: +5 °F to +104 °F.
- Mountable in any plane.

OPTIONS

- Special voltages.
- Surface treatment or plating.
- Gas tight sealing.
- Special designs available.

ACCESSORIES

- Inlet and/or inline filters.
- Additional inlet/outlet silencers.
- Safety valves.
- Flow converting devices.
- Optionals connectors

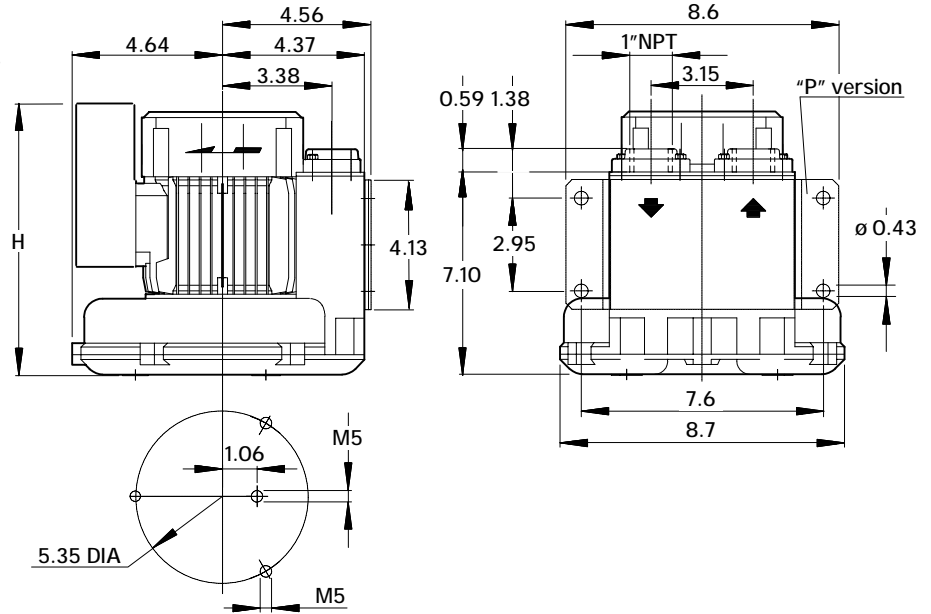

Dimensions in inches.
 Dimension for reference only.

Model	Maximum flow Scfm		Installed power Hp		Maximum differential pressure Δp (In WG)		Noise level Lp dB (A) (1)		Overall dimensions H Inches	Weight Lbs
	60 Hz 3500 rpm	50 Hz 2900 rpm	60 Hz 3500 rpm	50 Hz 2900 rpm	60 Hz 3500 rpm	50 Hz 2900 rpm	60 Hz 3500 rpm	50 Hz 2900 rpm		
06	39	32	1/3	-	36	-	58.7	-	10.60	18.30
			1/2	1/2	52	36	59.0	58.0	10.60	18.50

(1) Noise measured at 1 m distance with inlet and outlet ports piped, in accordance to ISO 3744.

- For proper use, the blower should be equipped with inlet filter and safety valve; other accessories available on request.
- Ambient temperature from +5° to +104°F.
- Specifications subject to change without notice.

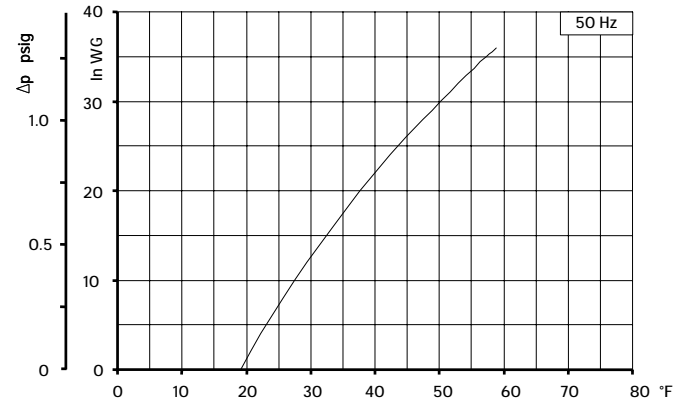
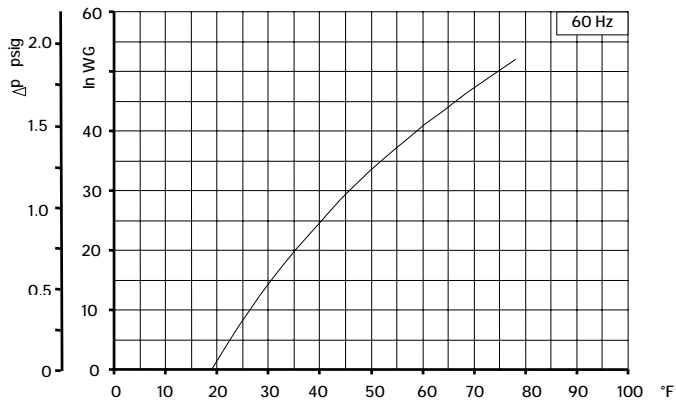
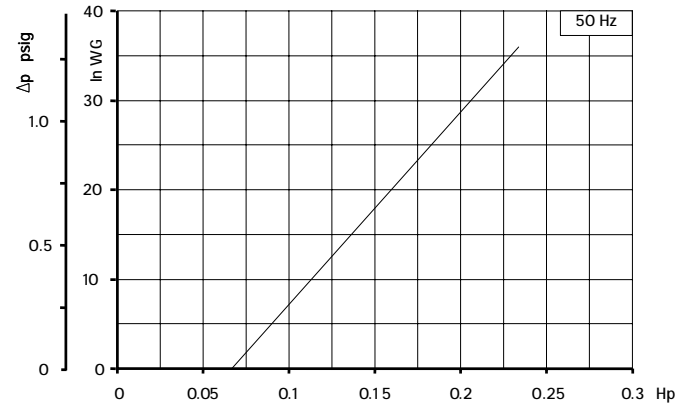
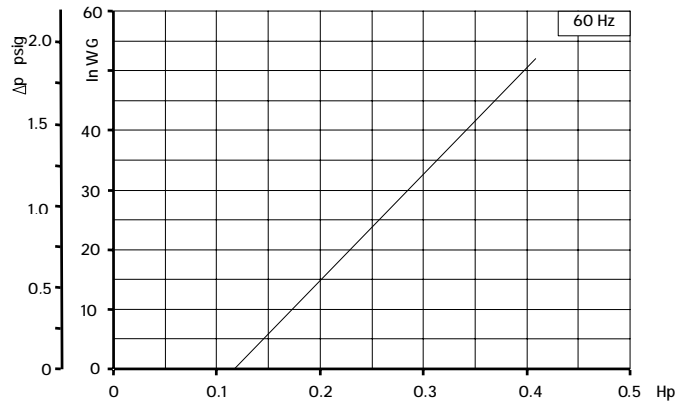
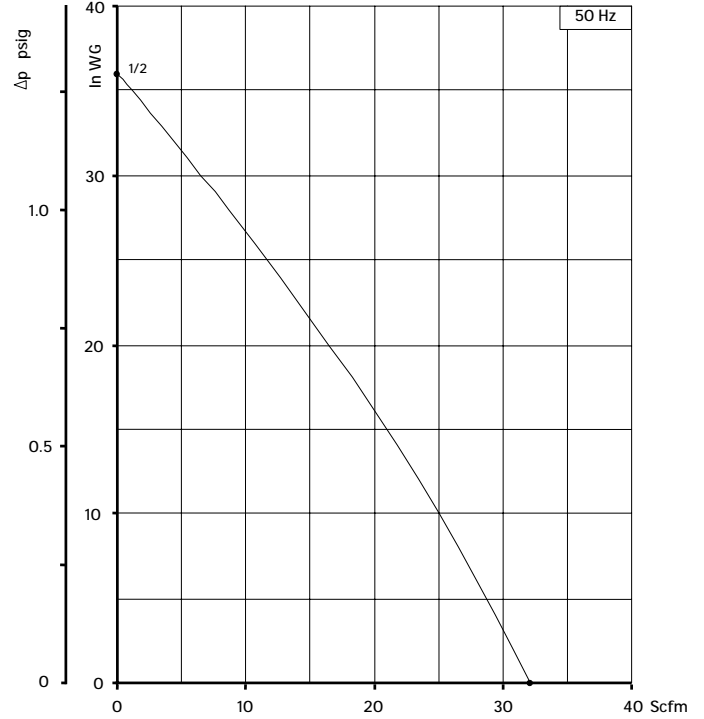
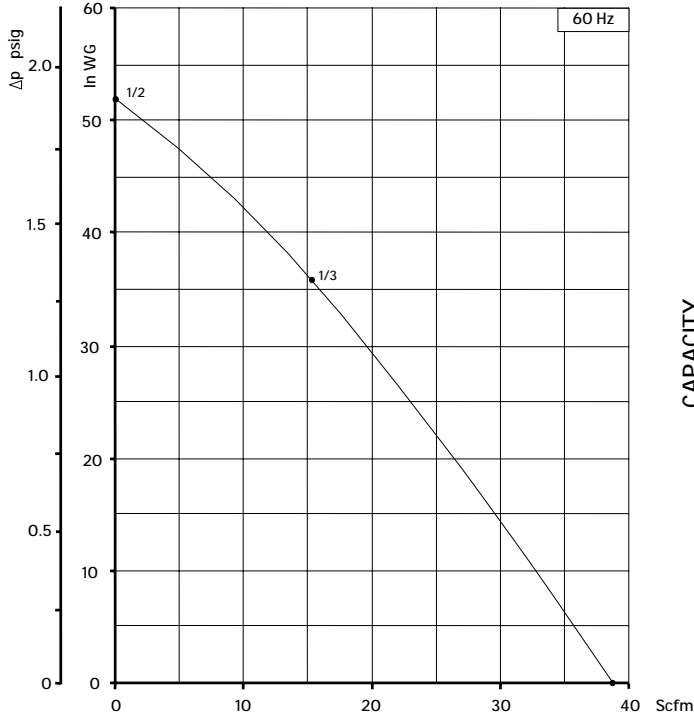

Curves refer to air at 68°F temperature and 29.92 In Hg atmospheric pressure (abs) measured at inlet port.
 Values for flow, power consumption and temperature rise: +/-10% tolerance.
 Data subject to change without notice.

STANDARD FEATURES

- Low weight cast aluminum construction.
- Quiet operation with integral inlet and outlet muffling.
- Recognized TEFC - cURus motor.
- High efficiency / low noise impeller design.
- No lubrication / maintenance required.
- Allowed ambient: +5 °F to +104 °F.
- Mountable in any plane.

OPTIONS

- Remote drive models (belt or coupling).
- Special voltages.
- Surface treatment or plating.
- Gas tight sealing.
- Special designs available.

ACCESSORIES

- Inlet and/or inline filters.
- Additional inlet/outlet silencers.
- Safety valves.
- Flow converting devices.
- Optionals connectors

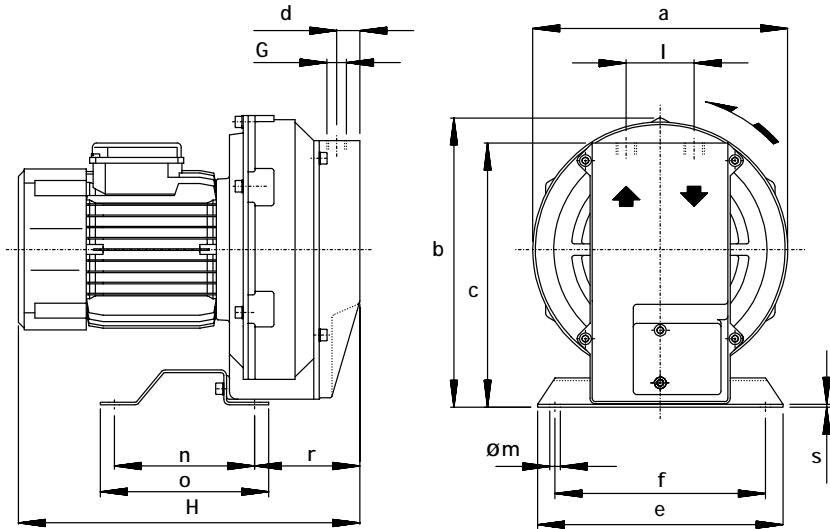

Dimensions in inches.
 Dimension for reference only.

Model	a	b	c	d	e	f	G	l	m	n	o	r	s
10DL	8.66	10.08	9.06	0.91	8.27	7.09	1/2" NPT	2.28	0.35	4.72	5.67	3.54	0.10
15DH	9.84	11.26	10.16	1.18	8.27	7.09	3/4" NPT	2.52	0.35	4.72	5.67	4.72	0.10

Model	Maximum flow Scfm		Installed power Hp		Maximum differential pressure Δp (In WG)		Noise level Lp dB (A) ⁽¹⁾		Overall dimensions H	Weight
	60 Hz 3500 rpm	50 Hz 2900 rpm	60 Hz 3500 rpm	50 Hz 2900 rpm	60 Hz 3500 rpm	50 Hz 2900 rpm	60 Hz 3500 rpm	50 Hz 2900 rpm		
10DL	21	18	1/3	1/3	60	65	63.7	61.7	12.20	21.80
			1/2	1/2	96	73	64.0	62.0	12.76	23.50
15DH	35	29	3/4	3/4	98	105	63.7	61.7	14.25	32.50
			1	1	120.5	120.5	64.0	62.0	15.75	40.00

(1) Noise measured at 1 m distance with inlet and outlet ports piped, in accordance to ISO 3744.

- For proper use, the blower should be equipped with inlet filter and safety valve; other accessories available on request.
- Ambient temperature from +5° to +104°F.
- Specifications subject to change without notice.

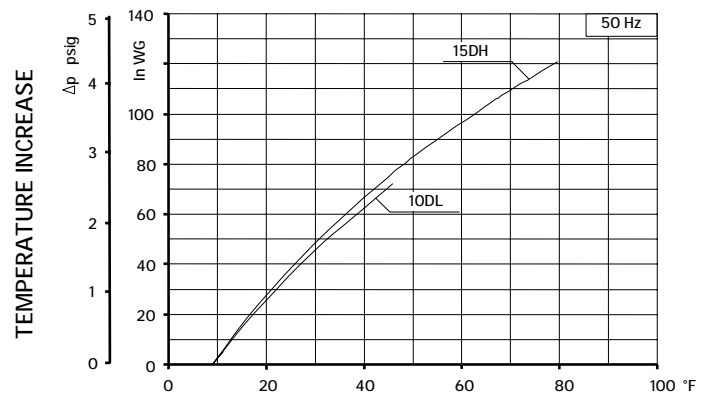
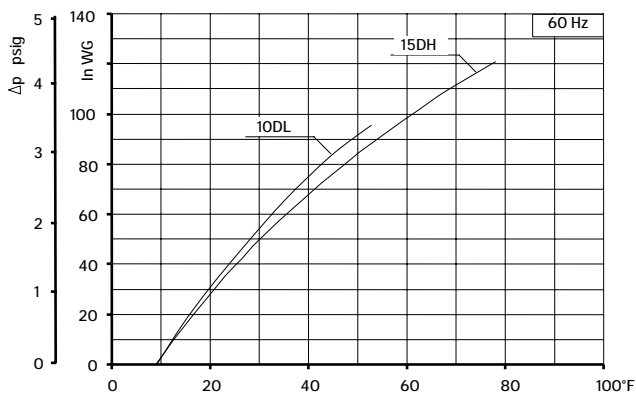
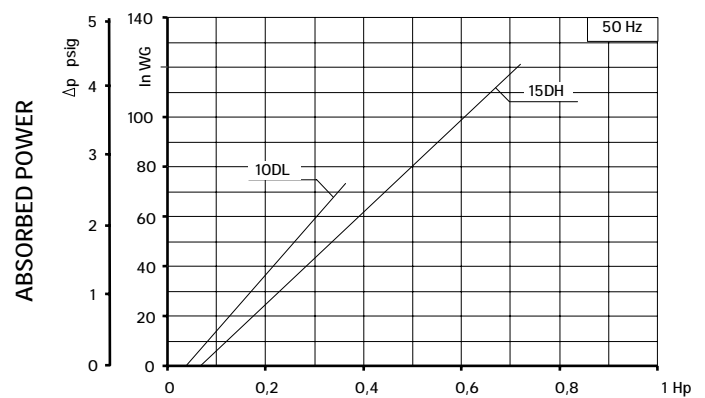
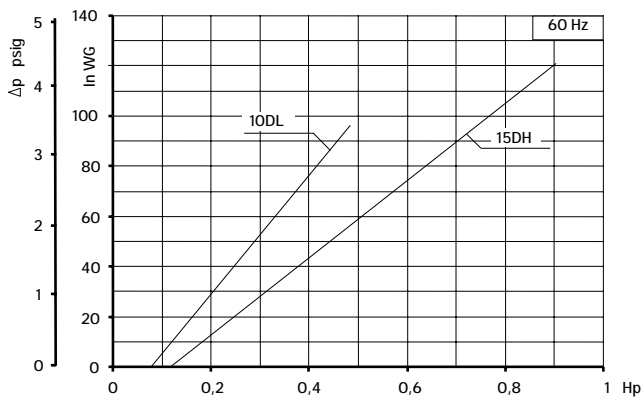
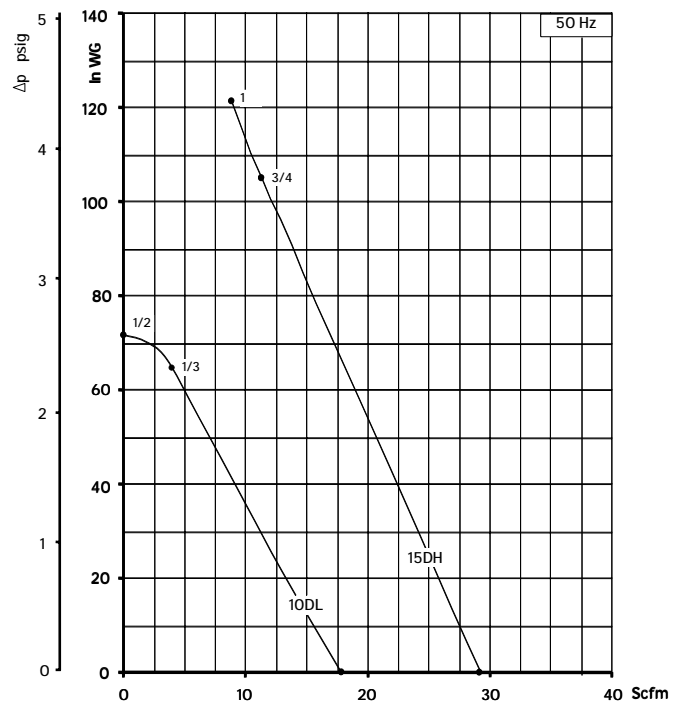
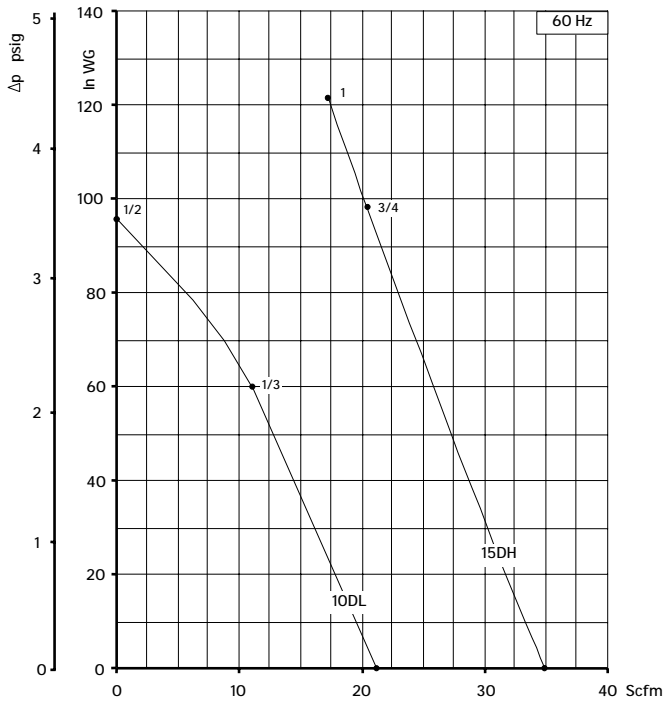

Curves refer to air at 68°F temperature and 29.92 In Hg atmospheric pressure (abs) measured at inlet port.
 Values for flow, power consumption and temperature rise: +/-10% tolerance.
 Data subject to change without notice.

STANDARD FEATURES

- Low weight cast aluminum construction.
- Quiet operation with integral inlet and outlet muffling.
- Recognized TEFC - cURus motor.
- High efficiency / low noise impeller design.
- No lubrication / maintenance required.
- Allowed ambient: +5 °F to +104 °F.
- Mountable in any plane.

OPTIONS

- Remote drive models (belt or coupling).
- Special voltages.
- Surface treatment or plating.
- Gas tight sealing.
- Special designs available.

ACCESSORIES

- Inlet and/or inline filters.
- Additional inlet/outlet silencers.
- Safety valves.
- Flow converting devices.
- Optionals connectors

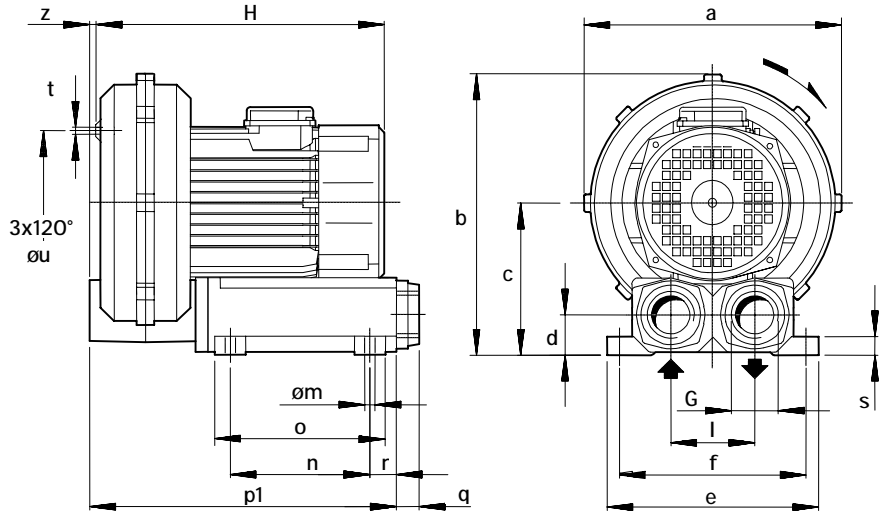

Dimensions in inches.
 Dimension for reference only.

Model	a	b	c	d	e	f	G	I	m	n	o	p1	q	r	s	t	u	z
R20-MD	11.22	12.20	6.57	1.77	9.05	8.27	1" ¼ NPT	3.54	0.40	5.90	7.68	13.5	0.71	1.77	0.78	M6	5.91	-
30DH	12.60	13.66	7.36	2.09	10.63	9.64	1" ½ NPT	4.13	0.39	7.28	9.25	16.54	0.71	2.17	0.79	M6	7.09	0.67
40DH	13.78	14.57	7.68	2.09	10.63	9.65	1" ½ NPT	4.13	0.39	7.28	9.25	17.32	0.71	2.17	0.79	M8	8.86	-

Model	Maximum flow Scfm		Installed power Hp		Maximum differential pressure Δp (In WG)		Noise level Lp dB (A) ⁽¹⁾		Overall dimensions H	Weight
	60 Hz	50 Hz	60 Hz	50 Hz	60 Hz	50 Hz	60 Hz	50 Hz		
	3500 rpm	2900 rpm	3500 rpm	2900 rpm	3500 rpm	2900 rpm	3500 rpm	2900 rpm	Inches	Lbs
R20-MD	41	34	1 ½	1 ½	150	150	68.0	65.0	13.86	47.30
30DH	70	61	2	2	140	161	69.7	67.7	15.36	58.30
			3	-	191	-	70.0	68.0	15.36	64.90
40DH	98	85	3	3	151	156	74.7	71.7	16.93	75.00
			4	4	201	201	75.0	72.0	16.93	83.80

(1) Noise measured at 1 m distance with inlet and outlet ports piped, in accordance to ISO 3744.

- For proper use, the blower should be equipped with inlet filter and safety valve; other accessories available on request.
- Ambient temperature from +5° to +104°F.
- Specifications subject to change without notice.

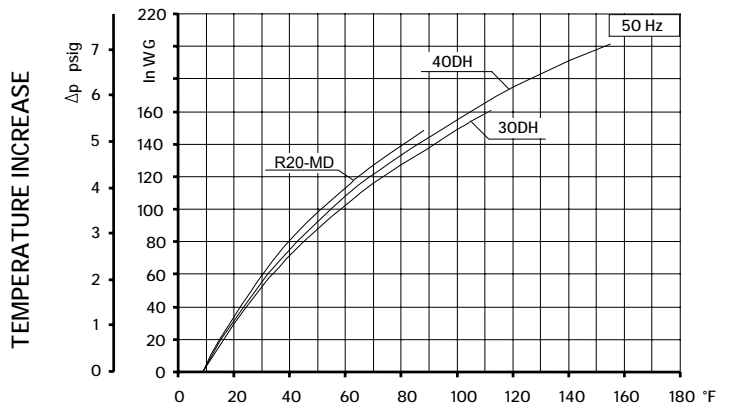
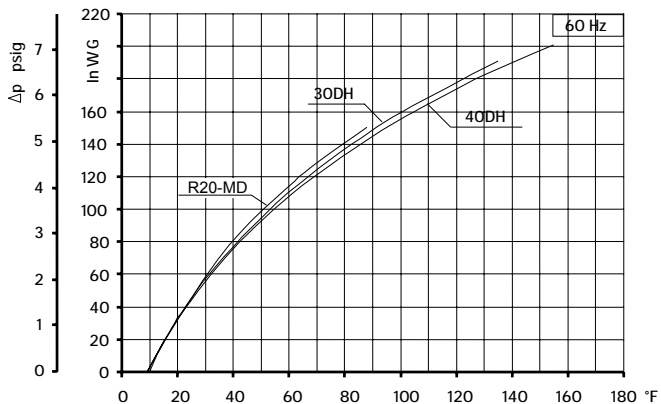
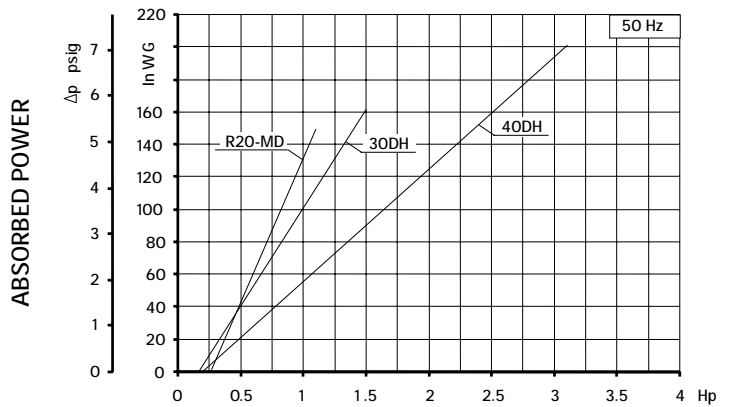
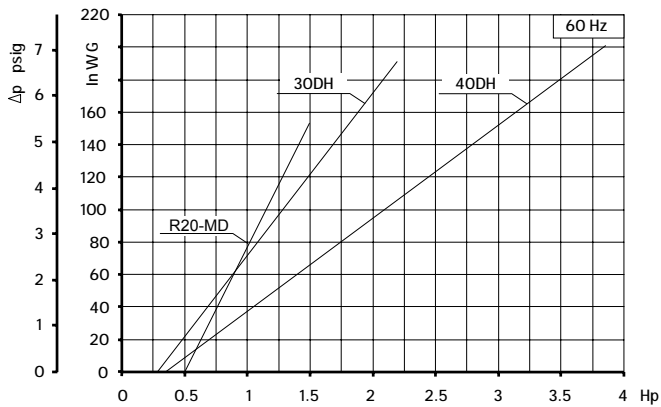
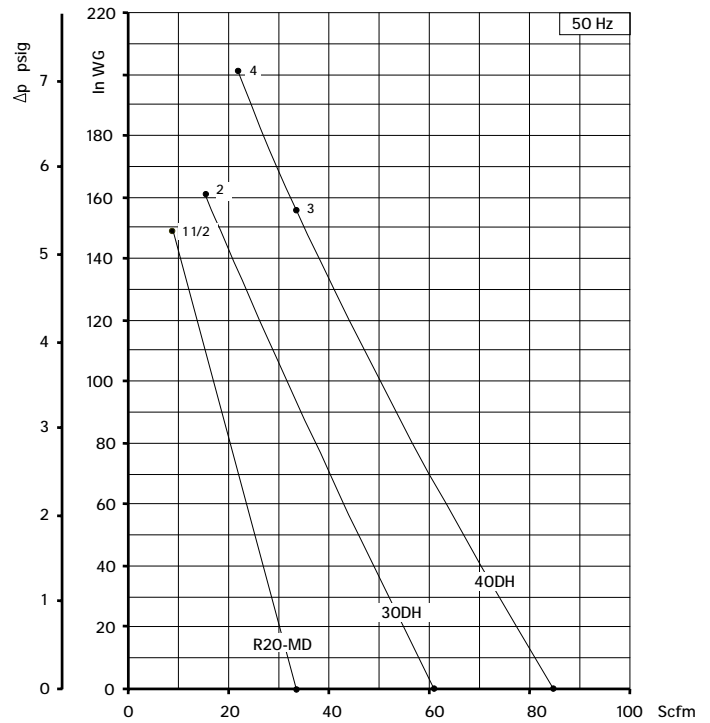
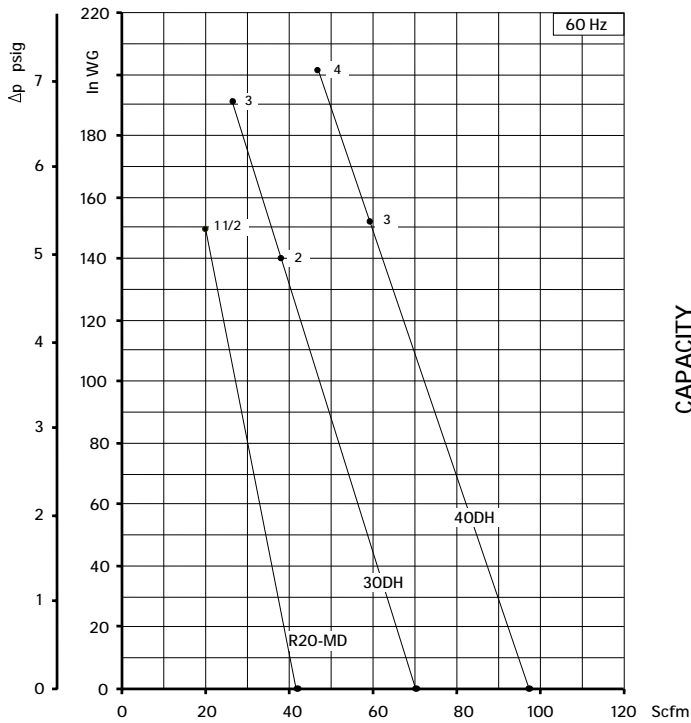

Curves refer to air at 68°F temperature and 29.92 In Hg atmospheric pressure (abs) measured at inlet port.
Values for flow, power consumption and temperature rise: +/-10% tolerance.
Data subject to change without notice.

TECHNICAL CHARACTERISTICS

- Aluminium alloy construction
- Smooth operation
- High efficiency impeller
- Maintenance free
- Mountable in any position

OPTIONS

- Special voltages (IEC 38)
- Surface treatments

ACCESSORIES

- Inlet and/or inline filters
- Additional inlet/outlet silencers
- Safety valves
- Flow converting device
- Optional connectors

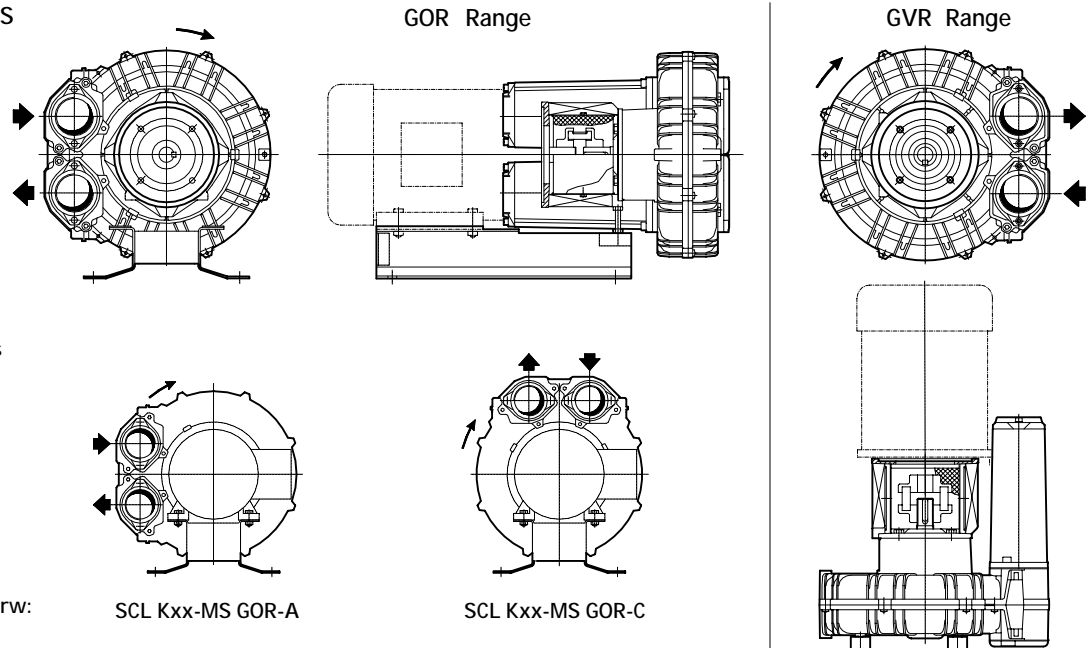

For dimensions, please refer to drw:

- GOR range: SI 1852
- GVR range: SI 1946

Model	Maximum flow Scfm		Installed power Hp	Size	Maximum differential pressure Dp (In WG)		Noise level Lp dB (A) (1)		Weight (2)	
	60 Hz 3500 rpm	50 Hz 2900 rpm			60 Hz 3500 rpm	50 Hz 2900 rpm	60 Hz 3500 rpm	50 Hz 2900 rpm	Lbs	
									GOR	GVR
K03-MS	52	43	3/4	NEMA 56C	64	60	62.0	60.0	22.00	17.60
			1	NEMA 56C	80		62.3			
K04-MS	98	81	1 1/2	NEMA 56C	58	80	64.8	62.8	27.60	22.00
			2	NEMA 56C	85	90	65.0			
			3	NEMA 56C	100	90		65.2		
K05-MS	156	129	2	NEMA 143-5TC	52	70	70.5	68.5	35.00	28.00
			3	NEMA 143-5TC	90	110	70.8			
			5	NEMA 182-4TC	130	120	71.1	69.1	34.50	27.00
K06-MS	216	179	3	NEMA 143-5TC	50	65	73.0	71.0	46.00	38.40
				NEMA 182-4TC						
			5	NEMA 182-4TC	85	110	73.6	71.6	40.80	38.00
7 1/2	NEMA 182-4TC	140	135	73.9	71.9					

(1) Noise measured at 1 m distance with inlet and outlet ports piped, in accordance to ISO 3744.

(2) Value is referred to weight of the machine without electric motor.

- For proper use, the blower should be equipped with inlet filter and safety valve; other accessories available on request.
- Ambient temperature from +5° to +104°F.
- Specifications subject to change without notice.

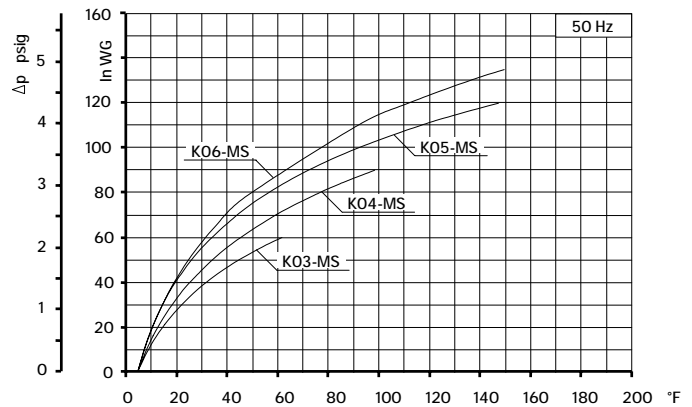
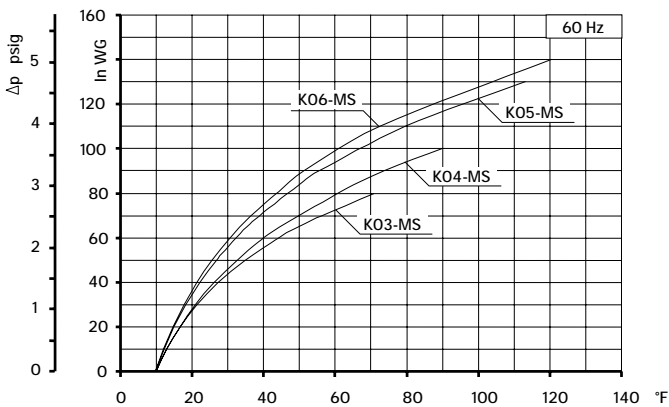
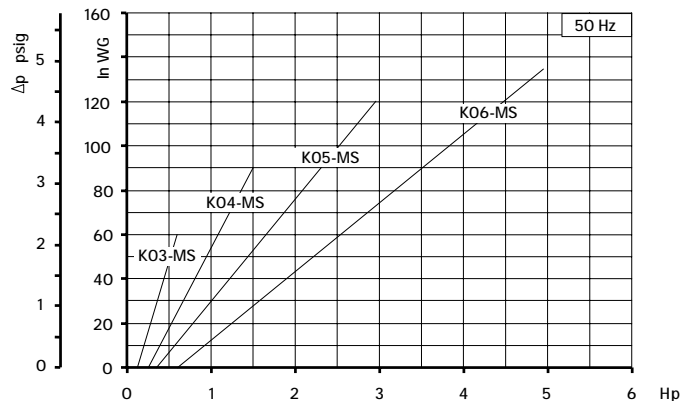
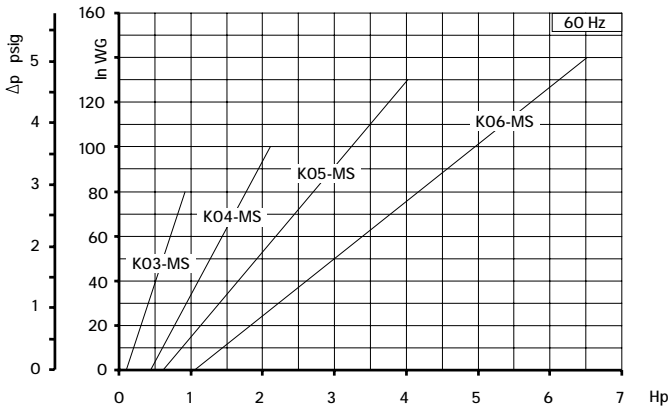
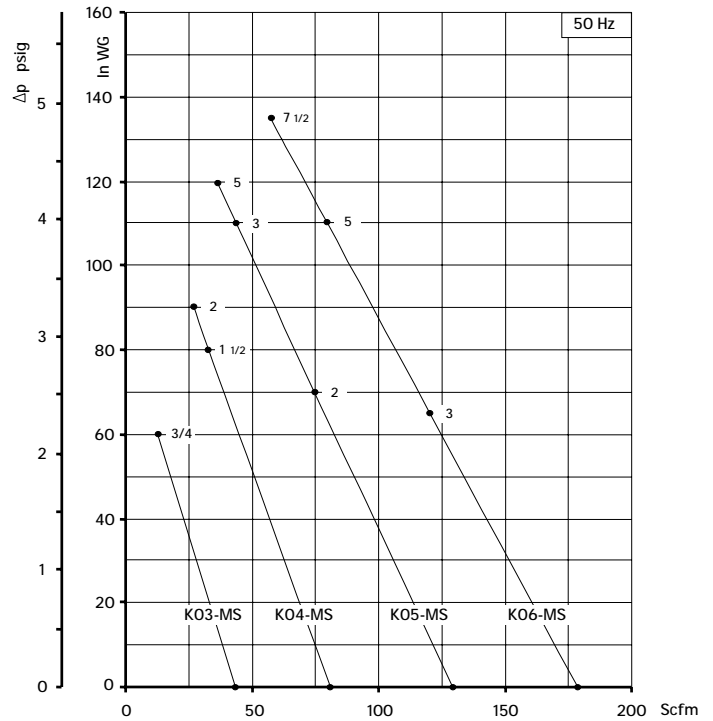
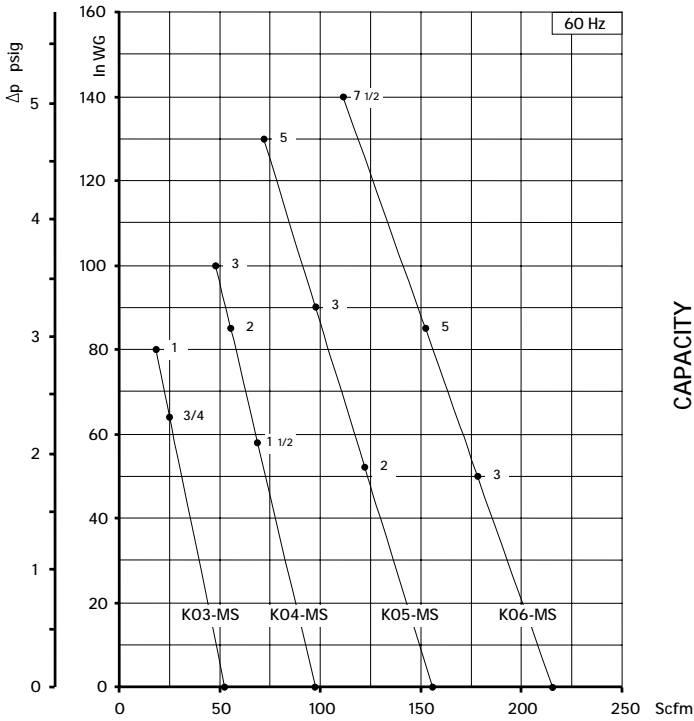

Curves refer to air at 68°F temperature and 29.92 In Hg atmospheric pressure (abs) measured at inlet port.
 Values for flow, power consumption and temperature rise: +/-10% tolerance.
 Data subject to change without notice.

TECHNICAL CHARACTERISTICS

- Aluminium alloy construction
- Smooth operation
- High efficiency impeller
- Maintenance free
- Mountable in any position

OPTIONS

- Special voltages (IEC 38)
- Surface treatments

ACCESSORIES

- Inlet and/or inline filters
- Additional inlet/outlet silencers
- Safety valves
- Flow converting device
- Optional connectors

For dimensions, please refer to drw:

GOR range: SI 1873

GVR range: SI 1920

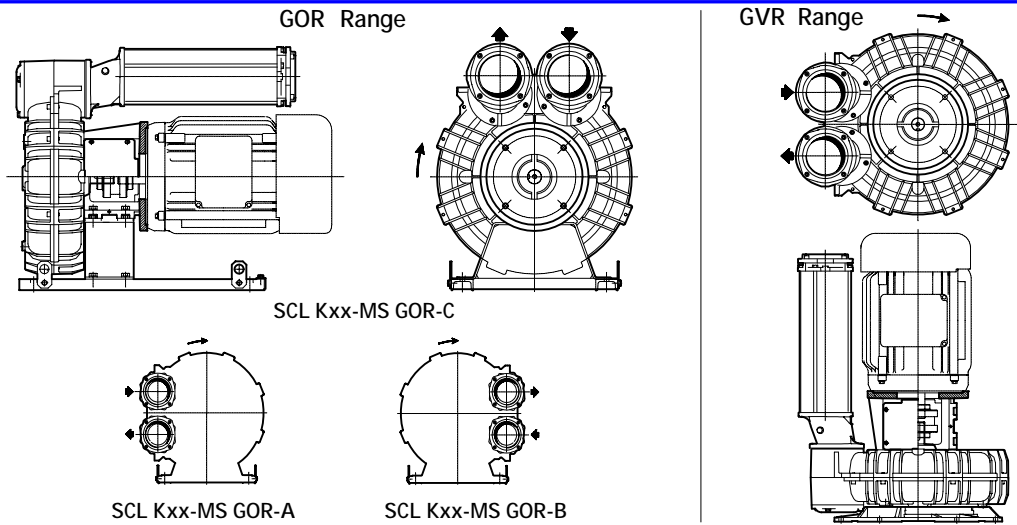

Model	Maximum flow Scfm		Installed power Hp	Size	Maximum differential pressure Δp (In WG)		Noise level Lp dB (A) ⁽¹⁾		Weight ⁽²⁾ Lbs
	60 Hz 3500 rpm	50 Hz 2900 rpm			60 Hz 3500 rpm	50 Hz 2900 rpm	60 Hz 3500 rpm	50 Hz 2900 rpm	
K07-MS	294	243	5	NEMA 182-4TC	70	86	79.0	77.0	110.5
			7 1/2	NEMA 182-4TC	130	140	79.3	77.3	110.5
				NEMA 213-5TC					110.5
			10	NEMA 213-5TC	170	79.6	110.5		
K08-MS	381	316	5	NEMA 182-4TC	38	52	79.7	77.7	127.0
			7 1/2	NEMA 182-4TC	68	90	80.0	78.0	127.0
				NEMA 213-5TC					127.0
			10	NEMA 213-5TC	115	125	80.3	78.3	127.0
			15	NEMA 213-5TC	170	160	80.6	78.6	127.0
NEMA 254-6TC	130.6								
K09-MS	471	390	7 1/2	NEMA 182-4TC	50	63	80.2	78.2	133.4
				NEMA 213-5TC					133.4
			10	NEMA 213-5TC	80	95	80.5	78.5	133.4
			15	NEMA 213-5TC	140	155	81.0	79.0	133.4
				NEMA 254-6TC					137.0
20	NEMA 254-6TC	180	170	81.3	79.3	137.0			
K10-MS	556	460	7 1/2	NEMA 182-4TC	30	50	80.1	78.1	147.3
				NEMA 213-5TC					147.3
			10	NEMA 213-5TC	60	80	80.5	78.5	147.3
			15	NEMA 213-5TC	110	135	81.0	79.0	147.3
				NEMA 254-6TC					151.0
			20	NEMA 254-6TC	160	190	81.4	79.4	151.0
25	NEMA 284-6TSC	200	81.6	147.3					
K11-MS	650	539	10	NEMA 213-5TC	40	53	82.0	80.0	170.0
			15	NEMA 213-5TC	80	97	82.4	80.4	170.0
				NEMA 254-6TC					176.4
			20	NEMA 254-6TC	125	140	82.7	80.7	176.4
			25	NEMA 284-6TSC	160	190	85.6	83.6	170.0
30	NEMA 284-6TSC	200	86.0	170.0					
K12MS	726	602	15	NEMA 213-5TC	52	90	82.9	80.9	177.7
				NEMA 254-6TC					184.1
			20	NEMA 254-6TC	85	130	83.2	81.2	184.1
			25	NEMA 284-6TSC	120	170	86.1	84.1	177.7
			30	NEMA 284-6TSC	150		86.5		177.7
40	NEMA 324-6TSC	180	86.9	193.2					

(1) Noise measured at 1 m distance with inlet and outlet ports piped, in accordance to ISO 3744.

- Specifications subject to change without notice.

(2) Value is referred to weight of the machine without electric motor

- For proper use, the blower should be equipped with inlet filter and safety valve; other accessories available on request.
 - Ambient temperature from +5° to +104°F.



REGENERATIVE BLOWERS - PRESSURE²⁹
SCL K07 / K08 / K09 / K10 / K11 / K12
MS SERIES - GOR/GVR RANGE
 SN 2134-3 2/2

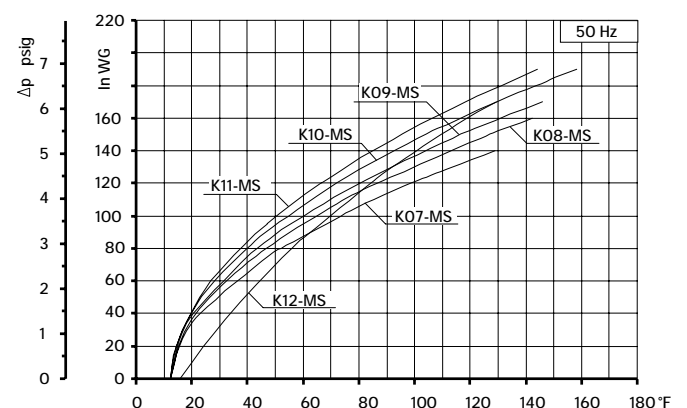
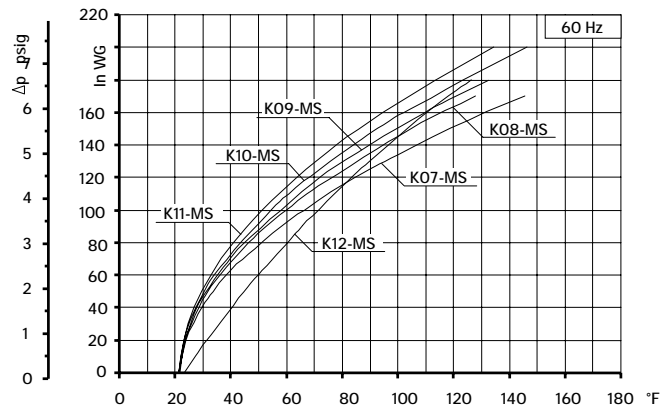
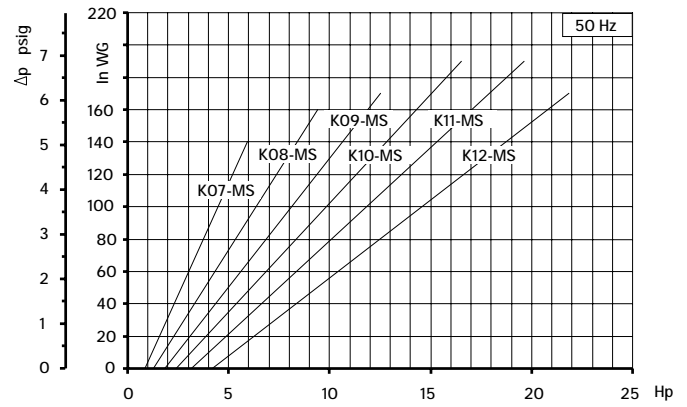
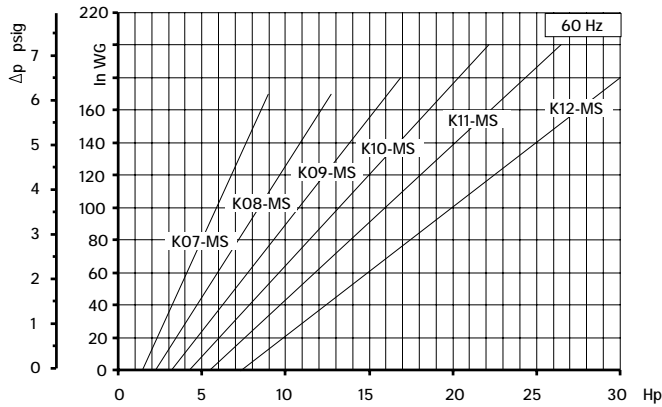
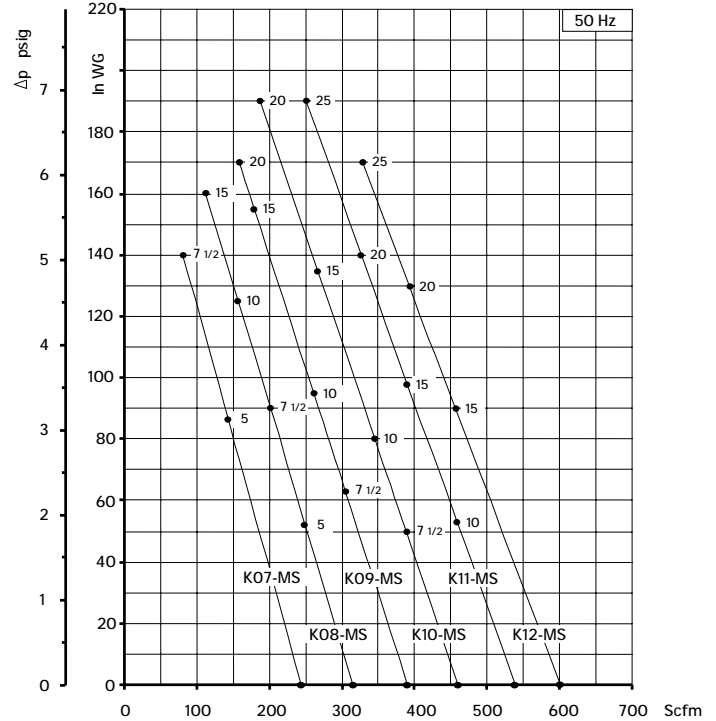
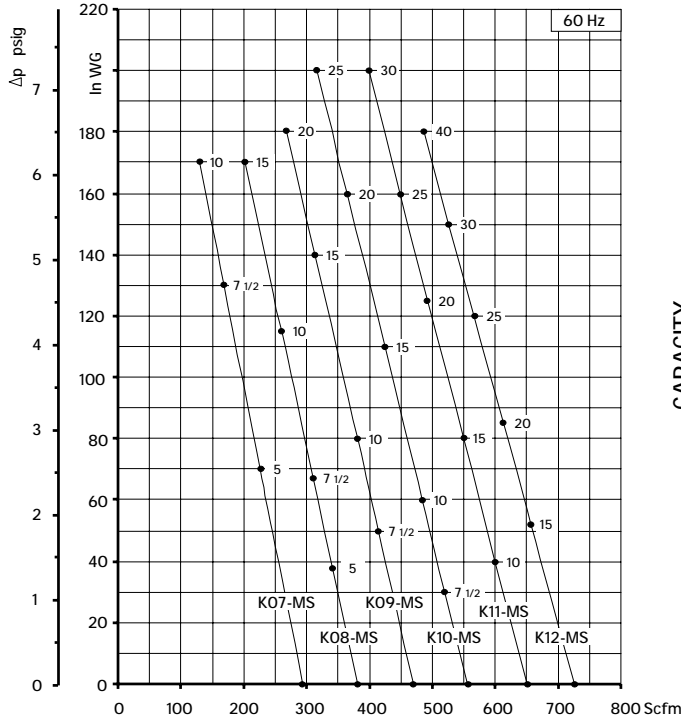

Curves refer to air at 68°F temperature and 29.92 In Hg atmospheric pressure (abs) measured at inlet port.
 Values for flow, power consumption and temperature rise: +/-10% tolerance.
 Data subject to change without notice.

TECHNICAL CHARACTERISTICS

- Aluminium alloy construction
- Smooth operation
- High efficiency impeller
- Maintenance free
- Mountable in any plane
- G1/8" female thread on both suction and discharge silencer port flanges.

OPTIONS

- Special voltages (IEC 38)
- Surface treatments

ACCESSORIES

- Inlet and/or inline filters
- Additional inlet/outlet silencers
- Safety valves
- Flow converting device
- Optional connectors

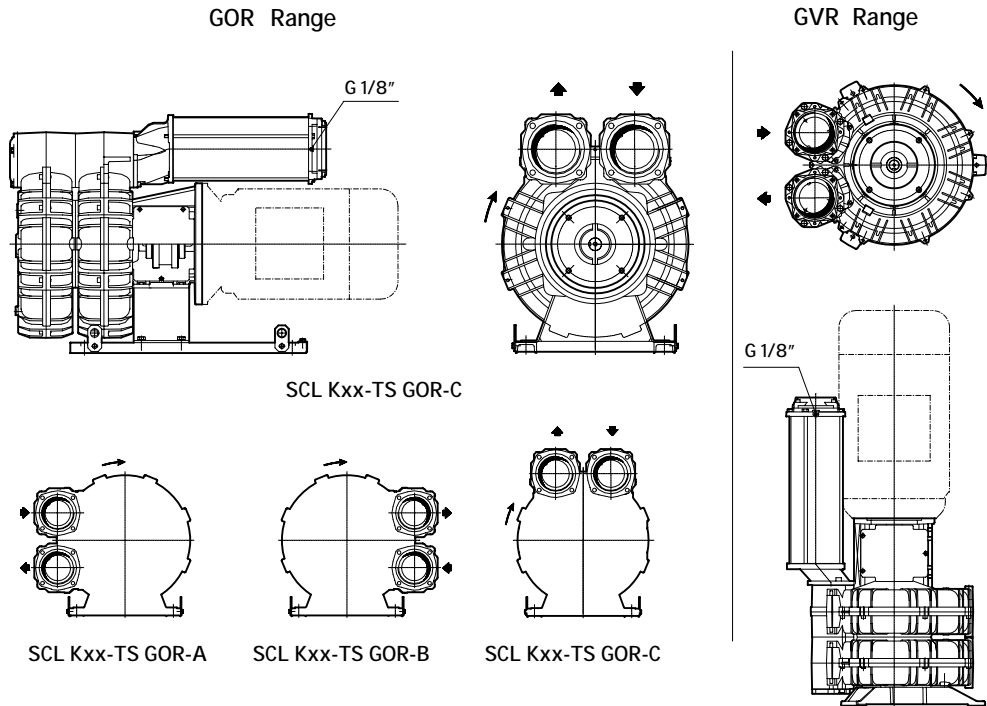

For dimensions, please refer to drw:

- GOR range: SI 21 23
- GVR range: SI 21 35

Model	Maximum flow m ³ /h		Installed power Hp	Size	Maximum differential pressure Δp (in WG)		Noise level Lp dB (A) (1)		Weight (2)	
	60 Hz 3500 rpm	50 Hz 2900 rpm			60 Hz 3500 rpm	50 Hz 2900 rpm	60 Hz 3500 rpm	50 Hz 2900 rpm	Lbs	
									GOR	GVR
K05-TS	290	241	5.0	NEMA 182-4TC	60	85	75.5	73.5	72.75	68.35
			7.5		100	110	77.5	75.5		
K06-TS	400	331	7.5	NEMA 213-5TC	55	77	77.5	75.5	112.45	108.00
			10		80	110	77.8	75.8		
			15		130	120	78.4	76.4		

(1) Noise measured at 1 m distance with inlet and outlet ports piped, in accordance to ISO 3744.

(2) Value is referred to weight of the machine without electric motor.

- For proper use, the blower should be equipped with inlet filter and safety valve; other accessories available on request.
- Ambient temperature from +5° to +104°F.
- Specifications subject to change without notice.

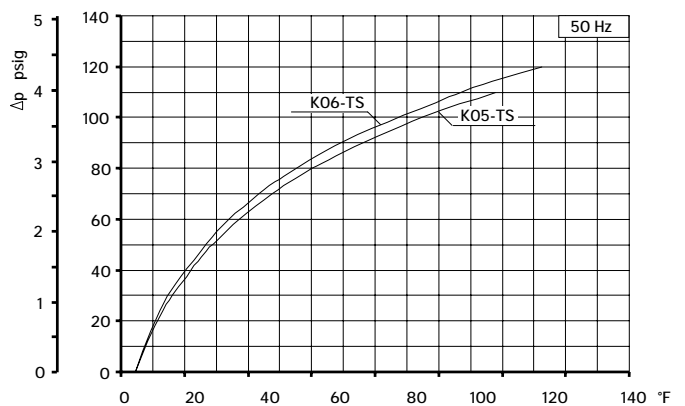
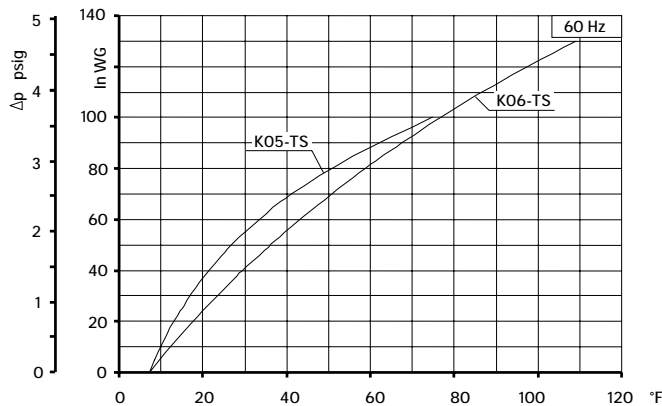
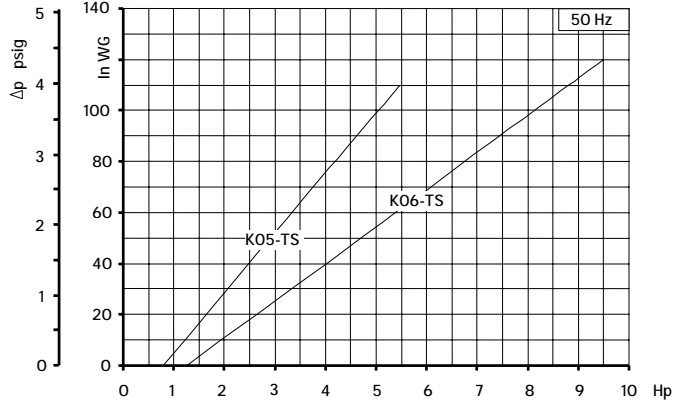
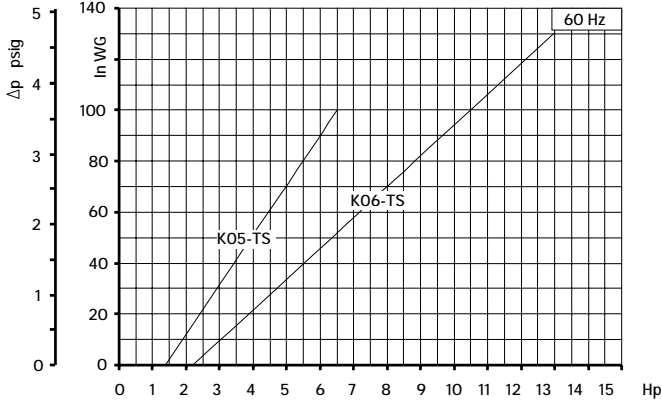
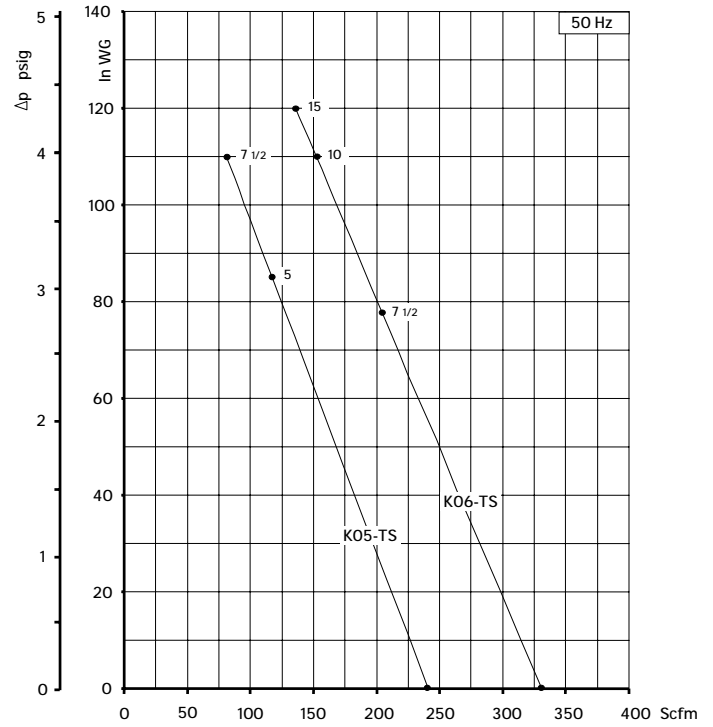
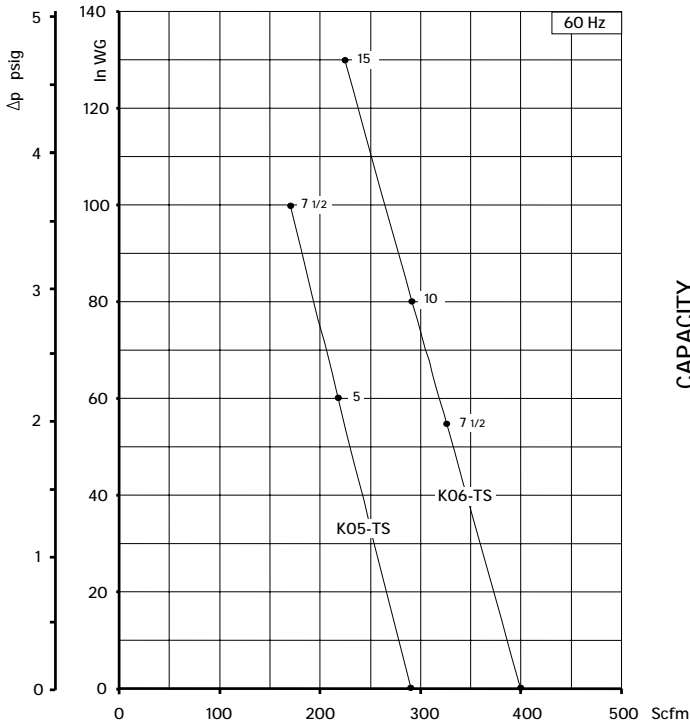

Curves refer to air at 68°F temperature and 29.92 In Hg atmospheric pressure (abs) measured at inlet port.
 Values for flow, power consumption and temperature rise: +/-10% tolerance.
 Data subject to change without notice.

TECHNICAL CHARACTERISTICS

- Aluminium alloy construction
- Smooth operation
- High efficiency impeller
- Maintenance free
- Mountable in any position
- G1/8" female thread on both suction and discharge silencer port flanges

OPTIONS

- Special voltages (IEC 38)
- Surface treatments

ACCESSORIES

- Inlet and/or inline filters
- Additional inlet/outlet silencers
- Safety valves
- Flow converting device
- Optional connectors

For dimensions, please refer to drw:

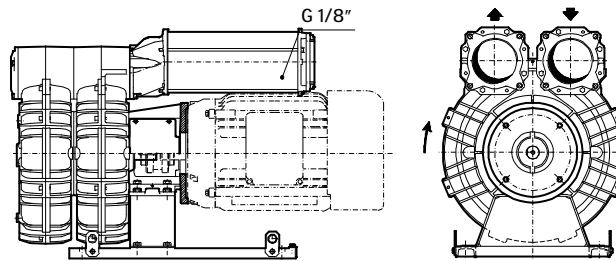
GOR range: SI 1879
GVR range: SI 1880
GOR RANGE

SCL Kxx-TS GOR-C

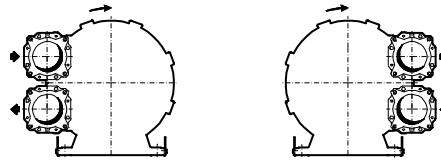

SCL Kxx-TS GOR-A

SCL Kxx-TS GOR-B

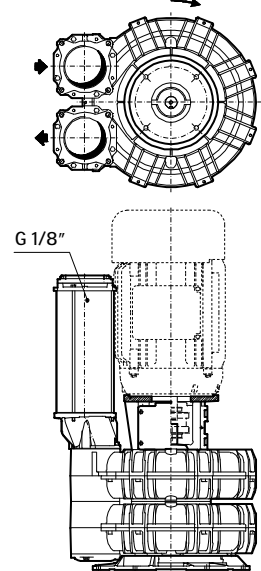
GVR RANGE

Model	Maximum flow Scfm		Installed power Hp	Size	Maximum differential pressure Δp (In WG)		Noise level Lp dB (A) (1)		Weight (2) Lbs
	60 Hz 3500 rpm	50 Hz 2900 rpm			60 Hz 3500 rpm	50 Hz 2900 rpm	60 Hz 3500 rpm	50 Hz 2900 rpm	
K07-TS	588	487	7 1/2	NEMA 182-4TC	36	60	83.9	81.9	160.90
				NEMA 213-5TC	36	60	83.9	81.9	160.90
			10	NEMA 213-5TC	60	90	84.2	82.2	160.90
				NEMA 213-5TC	110	140	84.8	82.8	160.90
				NEMA 254-6TC (3)	110	140	84.8	82.8	167.60
20	NEMA 254-6TC (3)	140	140	85.3	82.8	167.60			
K08-TS	715	592	10	NEMA 213-5TC	37	64	80.9	78.9	172.00
				NEMA 213-5TC	75	105	83.3	81.3	172.00
			15	NEMA 254-6TC (3)	75	105	83.3	81.3	180.80
				NEMA 254-6TC (3)	100	150	84.6	82.6	180.80
				NEMA 284-6TSC (3)	140	150	86.0	82.6	174.20
K09-TS	941	780	15	NEMA 213-5TC	52	75	83.0	81.0	202.80
				NEMA 254-6TC (3)	52	75	83.0	81.0	208.30
			20	NEMA 254-6TC (3)	80	108	85.0	83.0	208.30
				NEMA 284-6TSC (3)	110	145	87.0	85.0	205.00
				NEMA 284-6TSC (3)	120	160	89.0	87.0	205.00
40	NEMA 324-6TSC (3)	150	160	91.0	87.0	220.50			
K10-TS	1093	906	15	NEMA 213-5TC	41	64	87.8	85.8	209.40
				NEMA 254-6TC (3)	41	64	87.8	85.8	216.10
			20	NEMA 254-6TC (3)	65	90	88.1	86.1	216.10
				NEMA 284-6TSC (3)	80	110	88.4	86.4	211.60
				NEMA 284-6TSC (3)	100	140	88.7	86.7	211.60
40	NEMA 324-6TSC (3)	150	160	89.0	87.0	227.10			
K11-TS	1254	1039	25	NEMA 284-6TSC	50	88	89.4	87.4	251.30
				NEMA 284-6TSC	70	110	90.0	88.0	251.30
			40	NEMA 324-6TSC (3)	100	155	90.6	88.6	269.00
				NEMA 324-6TSC (3)	140	155	91.2	88.6	269.00
K12-TS	1410	1168	30	NEMA 284-6TSC	45	80	90.6	88.6	249.10
				NEMA 324-6TSC (3)	70	120	91.2	89.2	266.80
			50	NEMA 324-6TSC (3)	110	150	91.8	89.8	266.80

(1) Noise measured at 1 m distance with inlet and outlet ports piped, in accordance to ISO 3744.

(2) Value is referred to weight of the machine without electric motor

(3) Not applicable on SCL Kxx - GVR

- Ambient temperature from +5° to +104°F.

- Specifications subject to change without notice.

- For proper use, the blower should be equipped with inlet filter and safety valve; other accessories available on request.

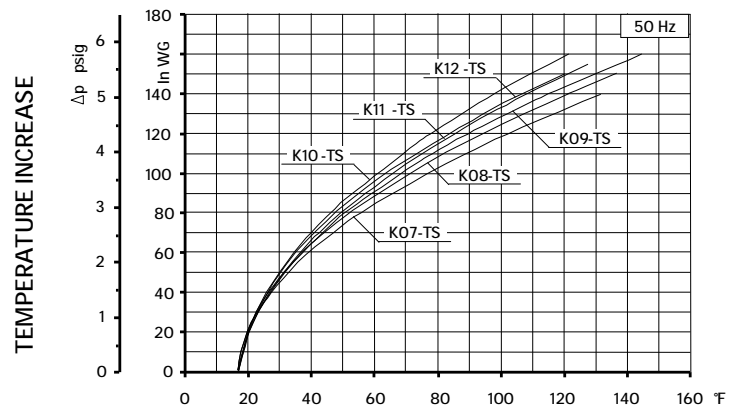
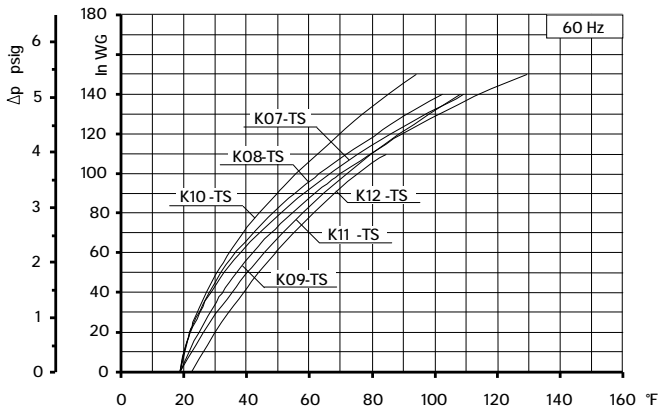
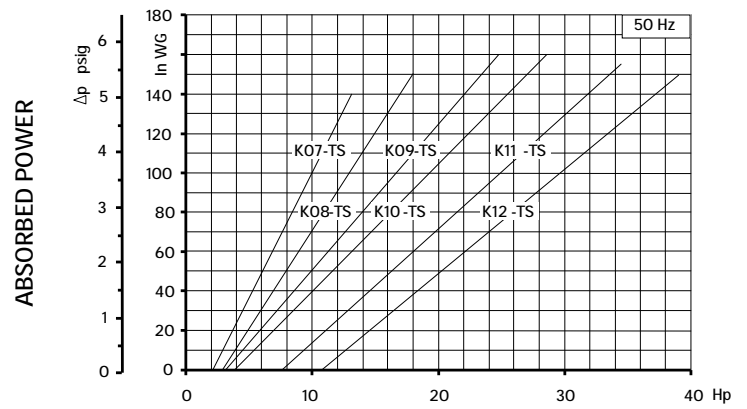
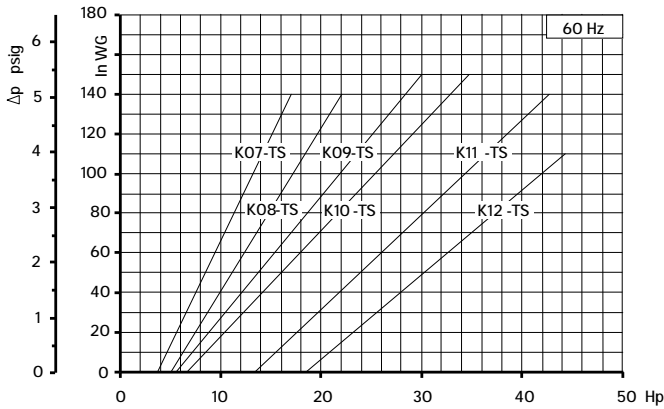
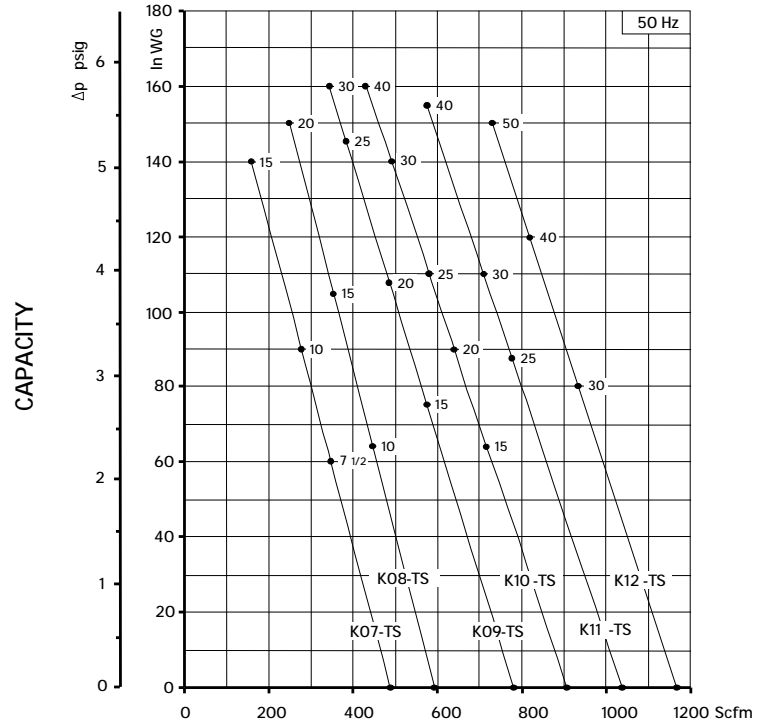
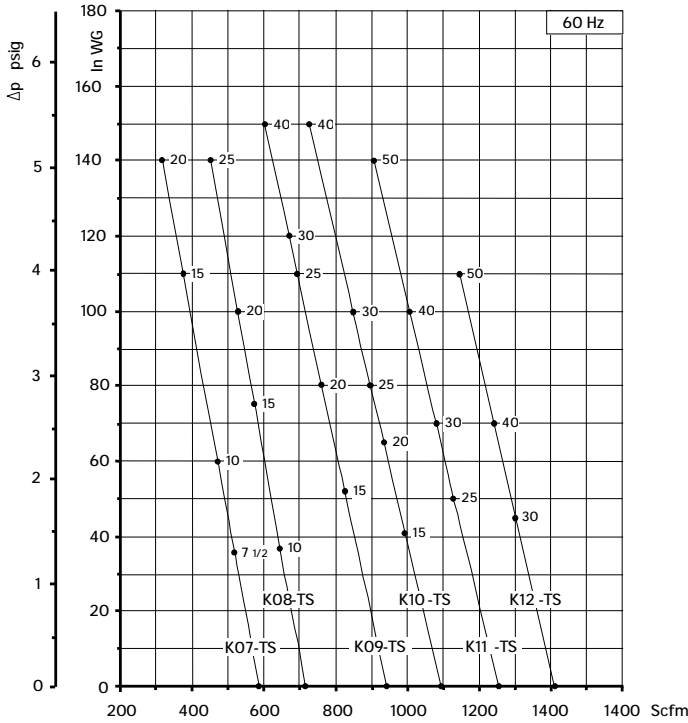

Curves refer to air at 68F temperature and 29.92 In Hg atmospheric pressure (abs) measured at inlet port.
 Values for flow, power consumption and temperature rise: +/-10% tolerance.
 Data subject to change without notice.

TECHNICAL CHARACTERISTICS

- Aluminium alloy construction
- Smooth operation
- High efficiency impeller
- Maintenance free
- Mountable in any position

OPTIONS

- Special voltages (IEC 38)
- Surface treatments

ACCESSORIES

- Inlet and/or inline filters
- Additional inlet/outlet silencers
- Safety valves
- Flow converting device
- Optional connectors

For dimensions, please refer to drw:

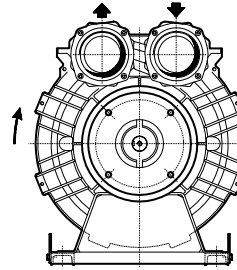
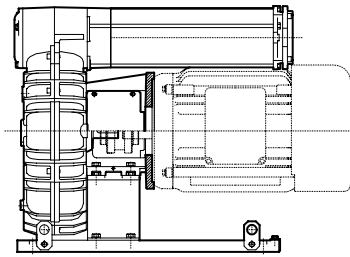
GOR range: SI 1918
GVR range: SI 1919
GOR Range

SCL Kxx-MD GOR-C

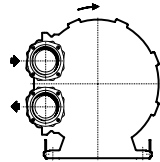

SCL Kxx-MD GOR-A

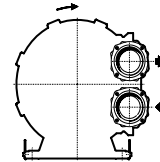

SCL Kxx-MD GOR-B

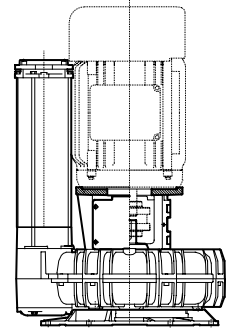
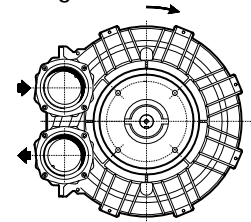
GVR Range

Model	Maximum flow Scfm		Installed power Hp	Size	Maximum differential pressure Δp (In WG)		Noise level Lp dB (A) ⁽¹⁾		Weight ⁽²⁾ Lbs
	60 Hz 3500 rpm	50 Hz 2900 rpm			60 Hz 3500 rpm	50 Hz 2900 rpm	60 Hz 3500 rpm	50 Hz 2900 rpm	
K07R-MD	129	107	3	NEMA 56C	68	87	73.5	71.5	112.00
				NEMA 143-5TC					112.00
			5	NEMA 182-4TC	145	170	74.5	72.5	113.80
			7 1/2	NEMA 182-4TC NEMA 213-5TC	250	260	75.0	73.0	113.80 113.80
K08R-MD	168	139	5	NEMA 182-4TC	80	110	76.2	74.2	130.30
			7 1/2	NEMA 182-4TC NEMA 213-5TC	160	185	76.6	74.6	130.30 130.30
			10	NEMA 213-5TC	220	250	77.0	75.0	130.30
			15	NEMA 213-5TC	260	-	77.4	-	130.30
K09-MD	221	183	5	NEMA 182-4TC	50	78	76.9	74.9	138.50
			7 1/2	NEMA 182-4TC NEMA 213-5TC	120	143	78.0	76.0	138.50 138.50
			10	NEMA 213-5TC	190	210	79.5	77.5	138.50
			15	NEMA 213-5TC	280	280	80.5	78.5	138.50
K10-MD	275	228	7 1/2	NEMA 182-4TC NEMA 213-5TC	85	110	79.9	77.9	125.40 152.40
			10	NEMA 213-5TC	140	165	80.3	78.3	152.40
			15	NEMA 213-5TC	245	280	81.4	79.4	152.40
K11-MD	306	254	10	NEMA 213-5TC	100	125	81.1	79.1	175.70
			15	NEMA 213-5TC NEMA 254-6TC	190	220	81.4	79.4	175.70 182.10
			20	NEMA 254-6TC	270	280	81.7	79.7	182.10
K12-MD	336	278	15	NEMA 213-5TC NEMA 254-6TC	100	180	82.3	80.3	183.40 189.80
			20	NEMA 254-6TC	180	260	82.6	80.6	189.80
			25	NEMA 284-6TSC	250	-	82.9	-	183.40

(1) Noise measured at 1 m distance with inlet and outlet ports piped, in accordance to ISO 3744.

(2) Value is referred to weight of the machine without electric motor

- For proper use, the blower should be equipped with inlet filter and safety valve; other accessories available on request.
- Ambient temperature from +5° to +104°F.
- Specifications subject to change without notice.

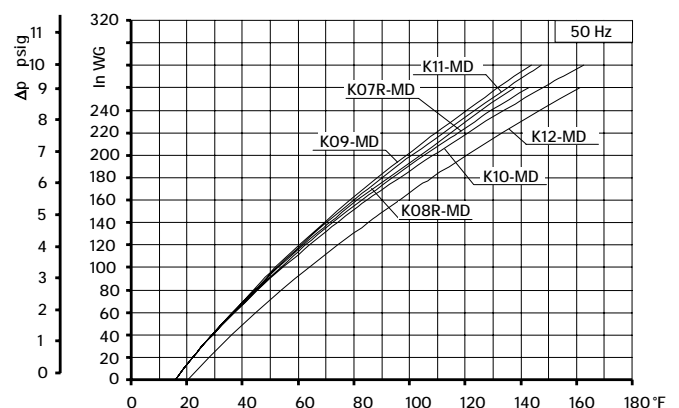
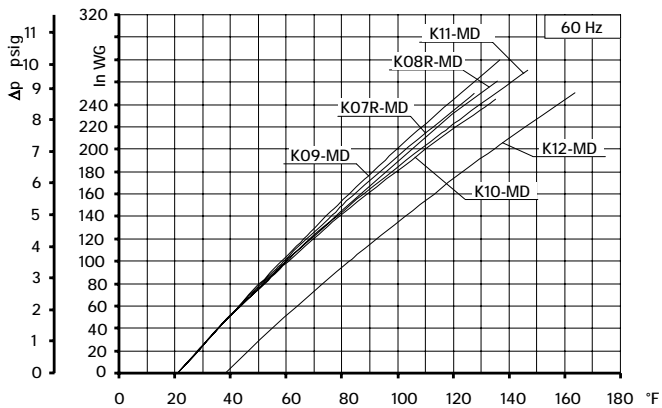
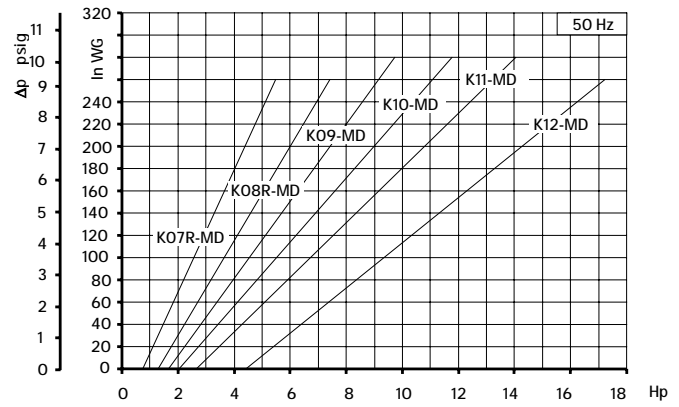
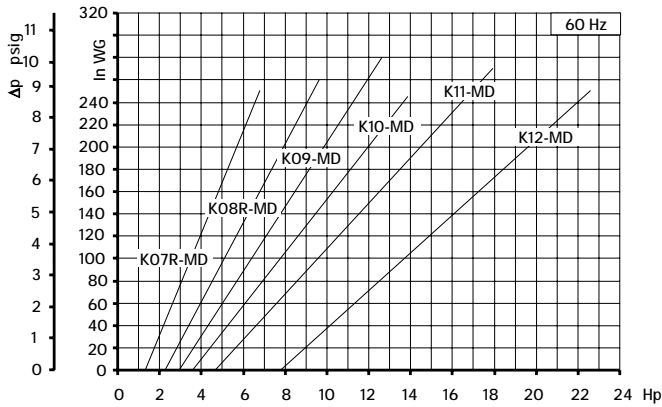
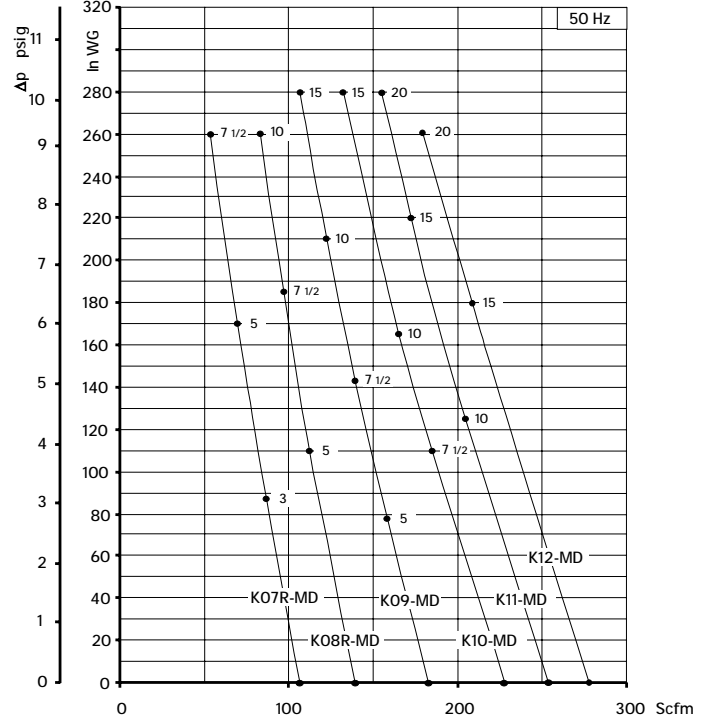
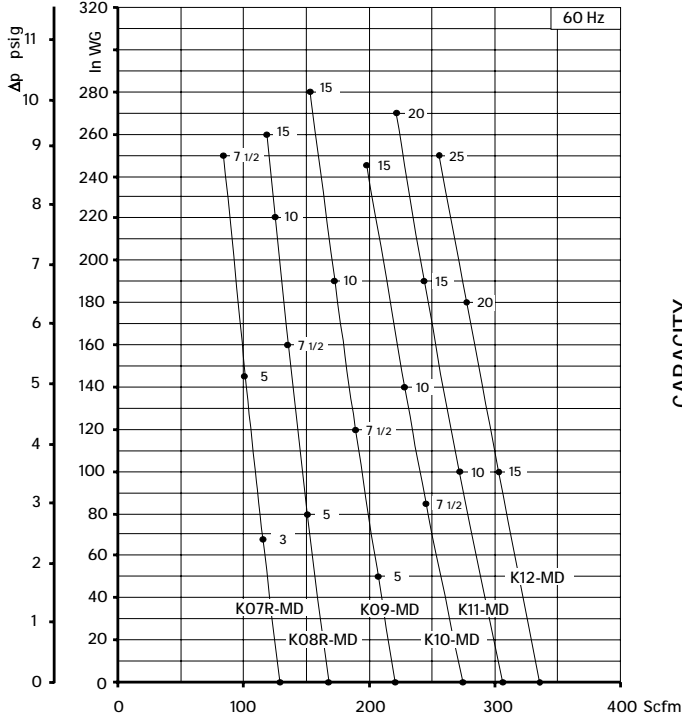

Curves refer to air at 68°F temperature and 29.92 In Hg atmospheric pressure (abs) measured at inlet port.
 Values for flow, power consumption and temperature rise: +/-10% tolerance.
 Data subject to change without notice.

TECHNICAL CHARACTERISTICS

- Aluminium alloy construction
- Smooth operation
- High efficiency impeller
- Maintenance free
- Mountable in any position
- G1/8" female thread on both suction and discharge silencer port flanges

OPTIONS

- Special voltages (IEC 38)
- Surface treatments

ACCESSORIES

- Inlet and/or inline filters
- Additional inlet/outlet silencers
- Safety valves
- Flow converting device
- Optional connectors

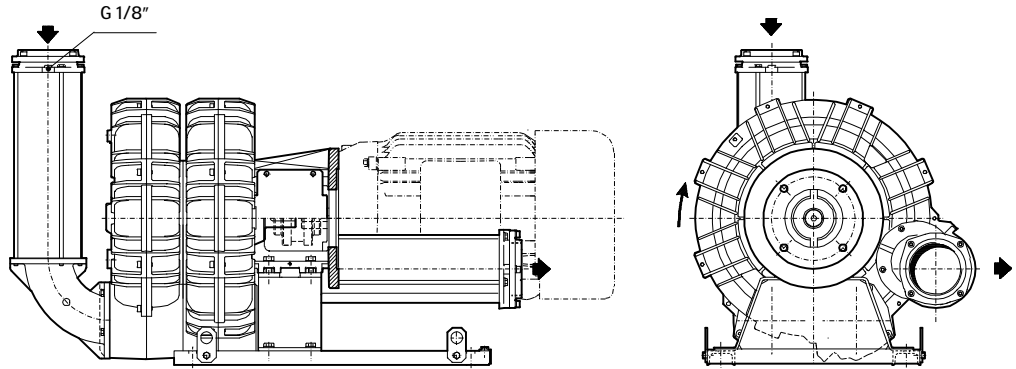

For dimensions, please refer to drw: SI1971

Model	Maximum flow Scfm		Installed power Hp	Size	Maximum differential pressure Δp (In WG)		Noise level Lp dB (A) ⁽¹⁾		Weight ⁽²⁾ Lbs		
	60 Hz 3500 rpm	50 Hz 2900 rpm			60 Hz 3500 rpm	50 Hz 2900 rpm	60 Hz 3500 rpm	50 Hz 2900 rpm			
K07-TD	296	245	7 1/2	NEMA 182-4TC	90	130	80.9	78.9	156.50		
				NEMA 213-5TC							
			10	NEMA 213-5TC	135	185	81.2	79.2		156.50	
			15	NEMA 213-5TC	225	230	81.8	79.8		160.90	
	NEMA 254-6TC	20	NEMA 254-6TC	240					82.1	160.90	
K08-TD	368	305	10	NEMA 213 -5TC	95	140	80.4	78.4	169.80		
			15	NEMA 213-5TC	170	220	81.5	79.5	169.00		
				NEMA 254-6TC					20	NEMA 254-6TC	220
K09-TD	467	387	15	NEMA 213-5TC	105	155	82.7	80.7	196.20		
				NEMA 254-6TC					20	NEMA 254-6TC	160
			25	NEMA 284-6TSC	220	240	83.3	81.3	198.40		
				NEMA 284-6TSC					30	NEMA 284-6TSC	240
K10-TD	571	473	15	NEMA 213-5TC	85	130	86.6	84.6	202.80		
				NEMA 254-6TC					20	NEMA 254-6TC	130
			25	NEMA 284-6TSC	180	240	87.2	85.2	205.00		
			30	NEMA 284-6TSC					200	87.5	205.00
				NEMA 324-6TSC					240	87.8	220.50
K11-TD	642	532	20	NEMA 254-6TC	90	140	87.4	85.4	246.80		
			25	NEMA 284-6TSC	130	180	87.9	85.9	244.70		
			30	NEMA 284-6TSC	150	240	88.4	86.4	244.70		
				NEMA 324-6TSC	240				88.9	264.50	
K12-TD	716	593	25	NEMA 284-6TSC	85	140	88.2	86.2	242.5		
			30	NEMA 284-6TSC	120	190	88.7	86.7	242.5		
			40	NEMA 324-6TSC	190	240	89,2	87.2	262.3		
				NEMA 324-6TSC	240	-	89.5	-	262.3		

(1) Noise measured at 1 m distance with inlet and outlet ports piped, in accordance to ISO 3744.

(2) Value is referred to weight of the machine without electric motor

- For proper use, the blower should be equipped with inlet filter and safety valve; other accessories available on request.
- Ambient temperature from +5°to +104°F.
- Specifications subject to change without notice.

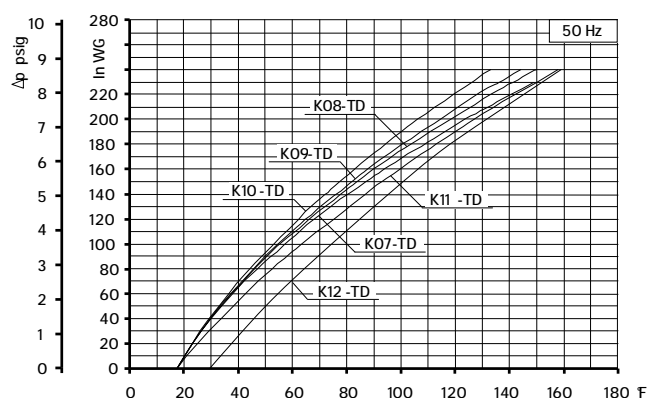
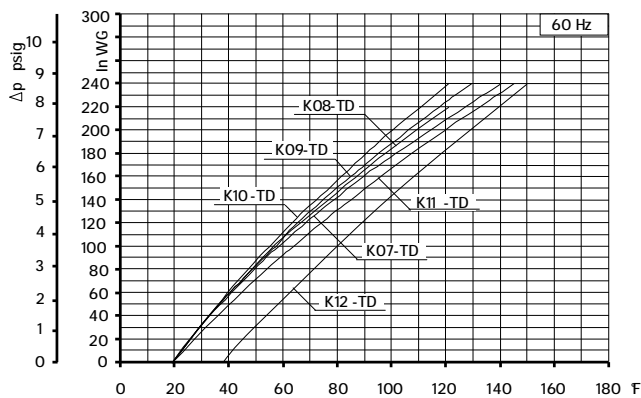
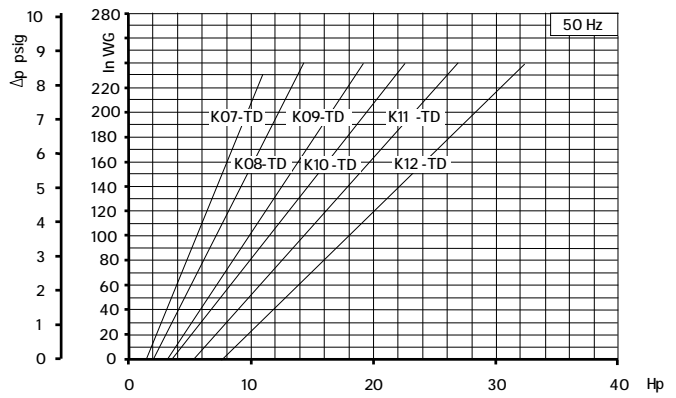
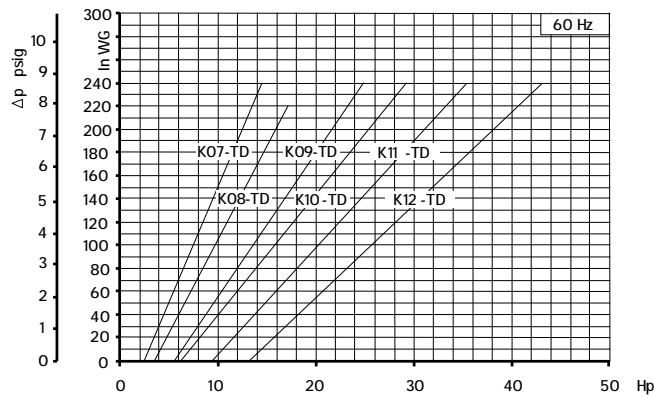
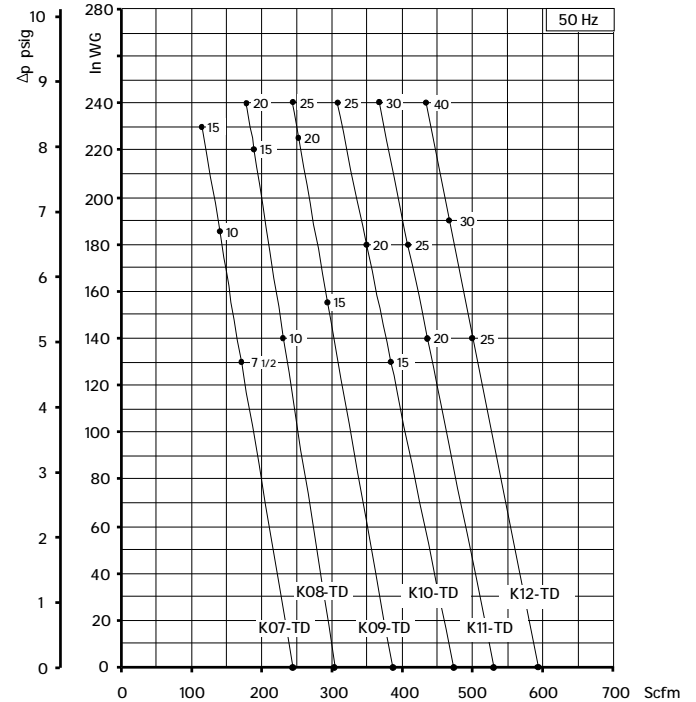
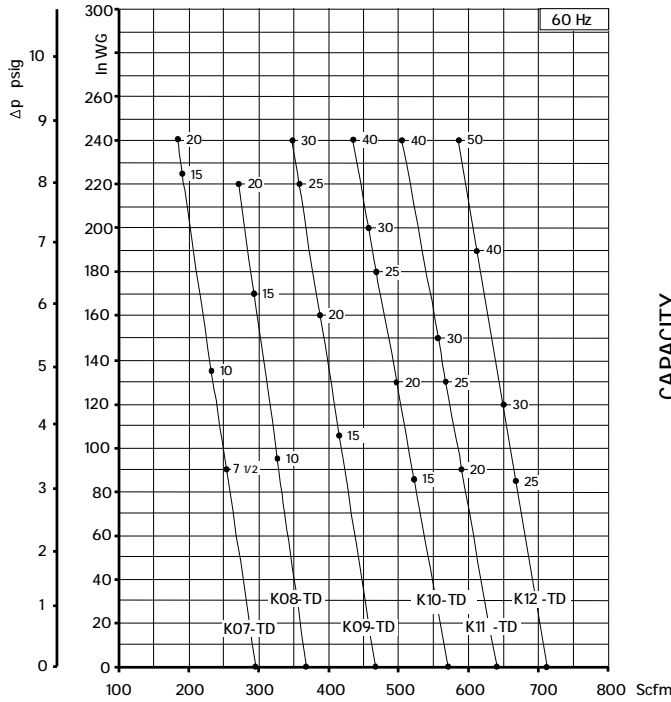

Curves refer to air at 68°F temperature and 29.92 In Hg atmospheric pressure (abs) measured at inlet port.
 Values for flow, power consumption and temperature rise +/-10% tolerance.
 Data subject to change without notice.

**TECHNICAL
CHARACTERISTICS**

- Aluminium alloy construction
- Smooth operation
- High efficiency impeller
- Maintenance free
- G1/8" female thread on both suction and discharge silencer port flanges

OPTIONS

- Special voltages (IEC 38)
- Surface treatments

ACCESSORIES

- Inlet and/or inline filters
- Additional inlet/outlet silencers
- Optional connectors

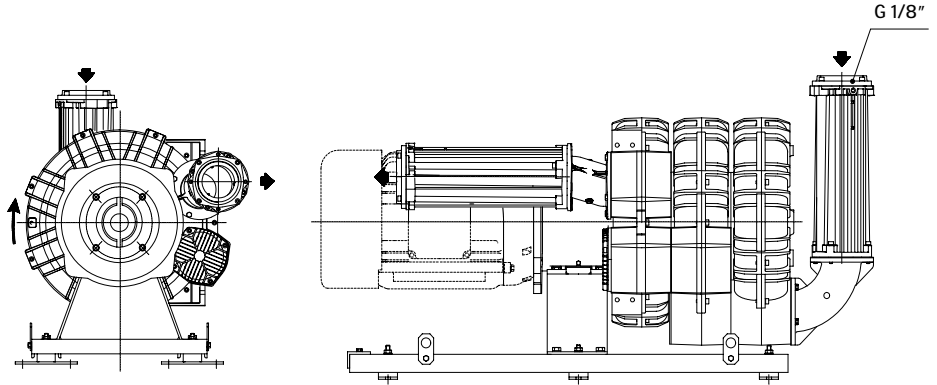

Model	Maximum flow Scfm		Installed power Hp	Size	Maximum differential pressure Δp (In WG)		Noise level Lp dB (A) (1)		Weight (2) Lbs
	60 Hz 3500 rpm	50 Hz 2900 rpm			60 Hz 3500 rpm	50 Hz 2900 rpm	60 Hz 3500 rpm	50 Hz 2900 rpm	
K09-TT	423	351	25	NEMA 284-6TSC	-	260	-	85.9	354
			30		220	330	88.2	86.2	
			40	NEMA 324-6TSC	330	-	88.5	-	
K10-TT	526	436	30	NEMA 284-6TSC	-	260	-	86.5	365
			40	NEMA 324-6TSC	260	340	88.8	86.8	380
			50		340	-	89.1	-	
K11-TT	597	495	40	NEMA 324-6TSC	220	300	89.1	87.1	434
			50		320	350	89.5	87.5	

(1) Noise measured at 1 m distance with inlet and outlet ports piped, in accordance to ISO 3744.

(2) Value is referred to weight of the machine without electric motor

- For proper use, the blower should be equipped with inlet filter and safety valve; other accessories available on request.
- Ambient temperature from +5° to +104°F.
- Specifications subject to change without notice.

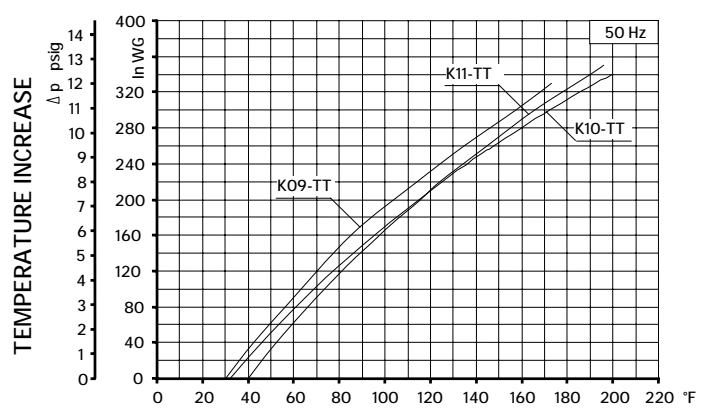
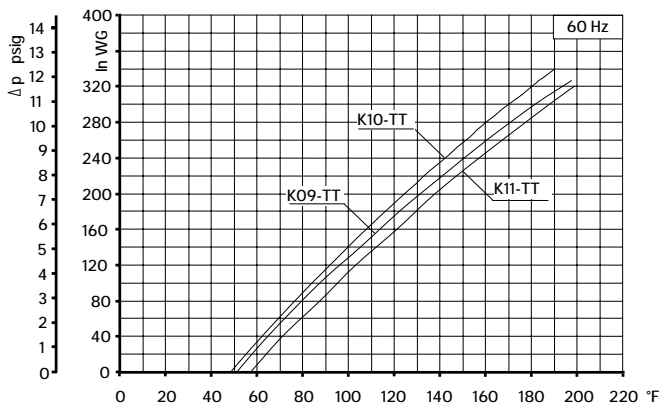
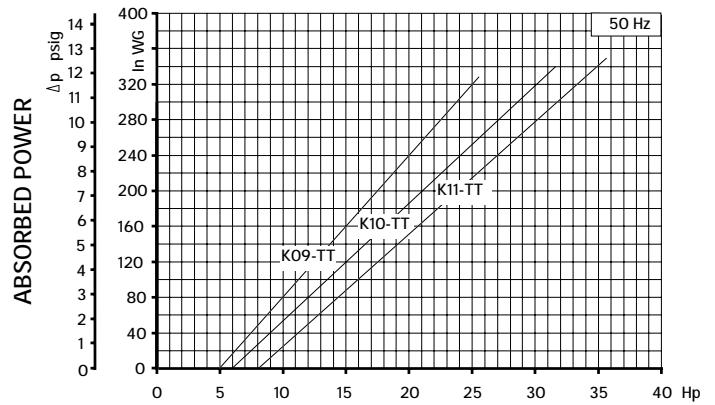
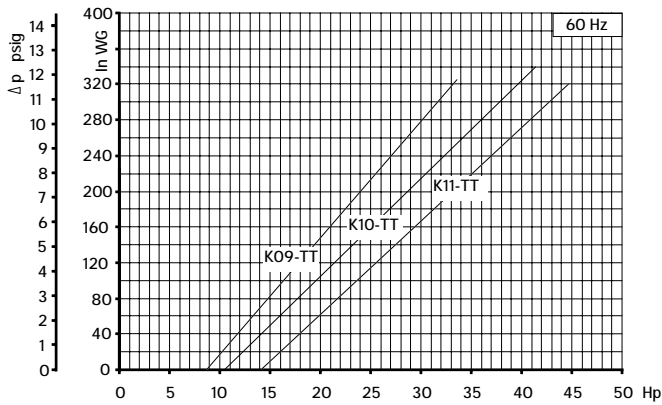
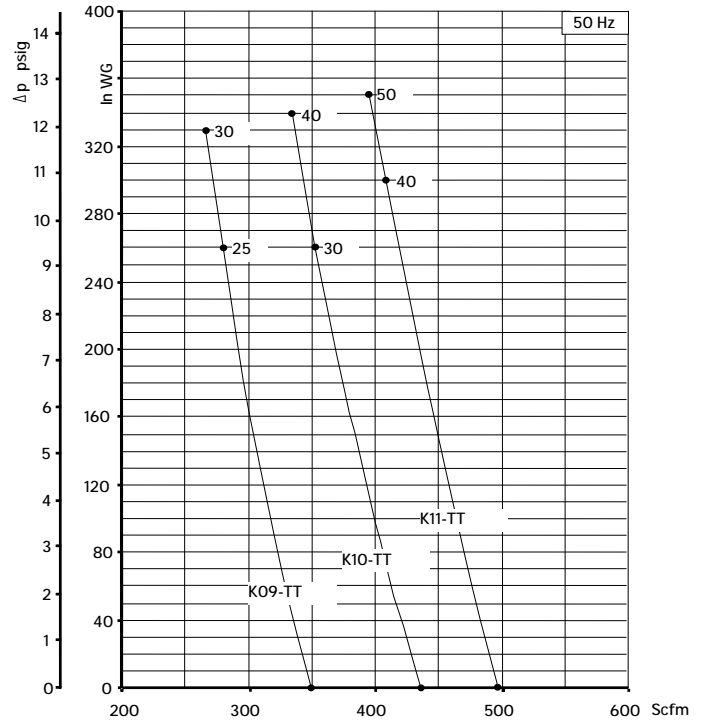
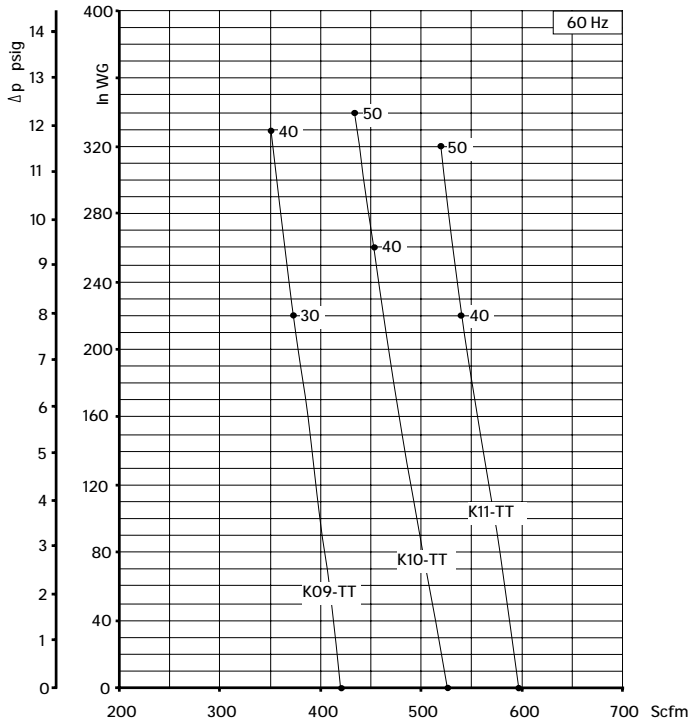

- Curves refer to air at 68°F temperature and 29.92 In Hg atmospheric pressure (abs) measured at inlet port.
- Values for flow, power consumption and temperature rise: +/-10% tolerance.
- Data subject to change without notice.

TECHNICAL CHARACTERISTICS

- Aluminium alloy construction
- Smooth operation
- High efficiency impeller
- Maintenance free
- Mountable in any position
- Recognized TEFC - cURus motor

OPTIONS

- Special voltages (IEC 38)
- Surface treatments

ACCESSORIES

- Inlet and/or inline filters
- Additional inlet/outlet silencers
- Safety valves
- Flow converting device
- Optional connectors

Dimensions in inches.

Dimension for reference only.

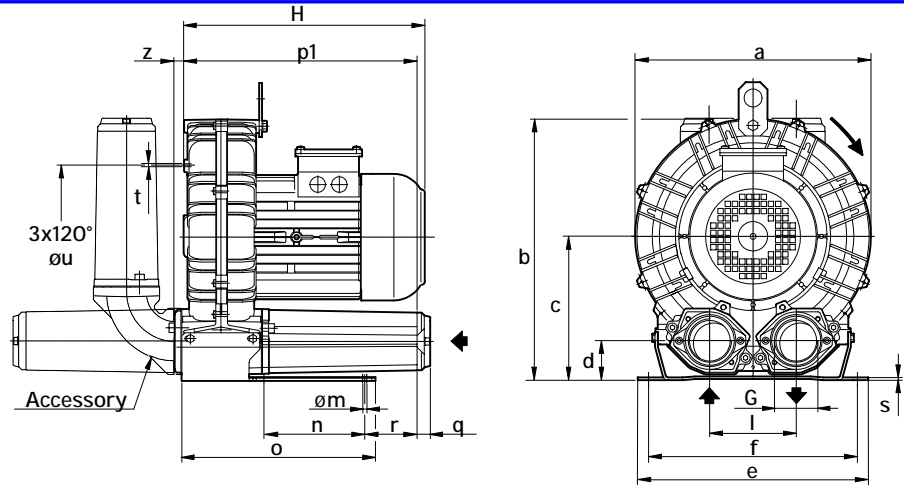

Model	a	b	c	d	e	f	G	l	m	n	o	p1	q	r	s	t	u	z
K03-MS	9.49	10.55	5.79	1.69	9.06	8.07	1" ¼ NPT	3.39	0.39	3.27	5.59	8.07	0.71	2.95	0.16	M6	5.51	0.47
K04-MS	11.22	12.40	6.77	1.93	10.04	8.86	1"½ NPT	4.02	0.47	3.74	6.73	8.74	0.71	2.76	0.16	M6	6.89	0.71
K05-MS	12.87	14.37	7.87	2.13	12.60	10.24	2" NPT	4.72	0.59	4.53	10.43	12.60	0.71	3.86	0.16	M8	7.87	0.75
K06-MS	14.80	15.47	8.07	2.13	12.80	11.42	2" NPT	4.92	0.59	5.51	10.71	13.15	0.71	3.35	0.16	M8	9.45	0.75

Model	Maximum flow cfm		Installed power Hp		Maximum differential pressure Δp (In Hg)		Noise level Lp dB (A) (1)		Overall dimensions H Inches	Weight Lbs
	60 Hz 3500 rpm	50 Hz 2900 rpm	60 Hz 3500 rpm	50 Hz 2900 rpm	60 Hz 3500 rpm	50 Hz 2900 rpm	60 Hz 3500 rpm	50 Hz 2900 rpm		
K03-MS	52	43	3/4	3/4	4.7	3.7	61.0	59.0	10.43	24.30
			1	1	5.9	4.9	61.3	59.3	11.97	26.50
K04-MS	98	81	1 ½	1 ½	4.3	5.9	63.8	61.8	11.65	36.40
			2	2	6.3	6.6	64.0	62.0	13.78	43.00
			3	-	7.4	-	64.2	-	13.78	49.60
K05-MS	156	129	2	2	3.8	5.1	69.5	67.5	13.20	51.80
			3	3	6.6	7.1	69.8	67.8	13.20	58.40
			4	-	8.1	-	70.1	-	14.40	67.20
K06-MS	216	179	3	3	3.7	4.8	72.0	70.0	13.54	68.70
			4	4	5.5	7.0	72.3	70.3	14.17	71.65
			5 ½	5 ½	8.1	8.1	72.6	70.6	14.17	77.60
			6 1/5 ⁽²⁾	-	9.6	-	72.9	-	14.45	77.60

(1) Noise measured at 1 m distance with inlet and outlet ports piped, in accordance to ISO 3744.

(2) No cURus motor

- For proper use, the blower should be equipped with inlet filter and safety valve; other accessories available on request.
- Ambient temperature from +5° to +104°F.
- Specifications subject to change without notice.

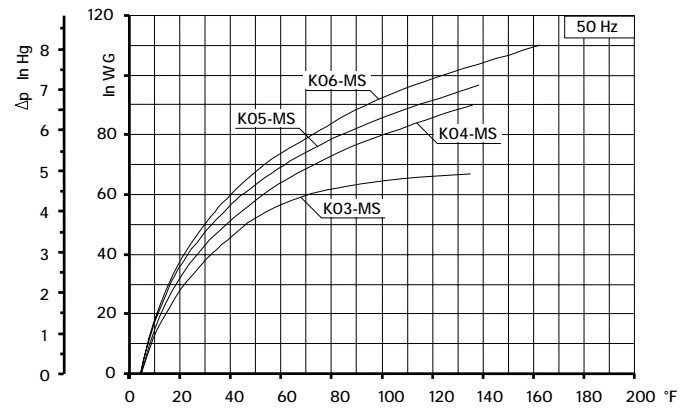
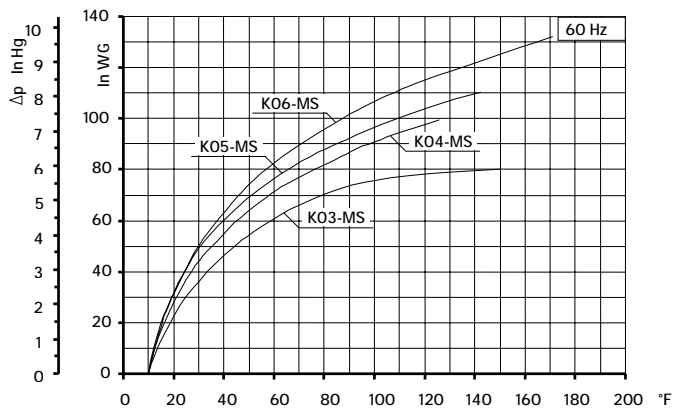
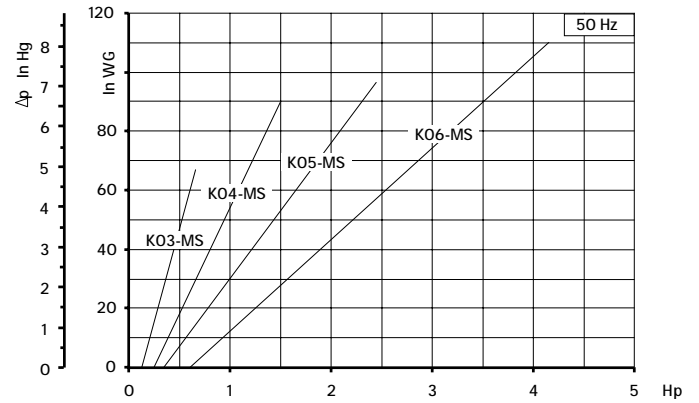
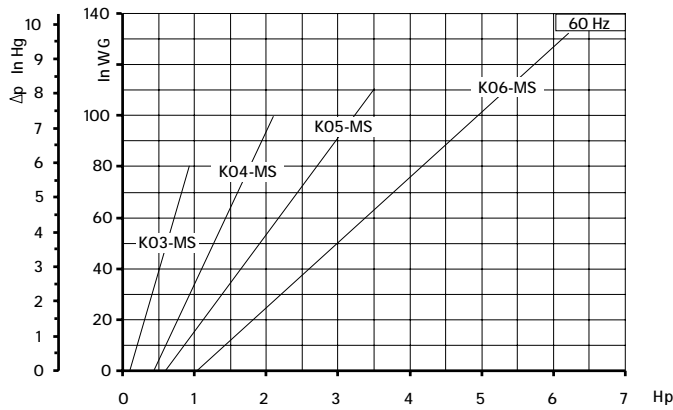
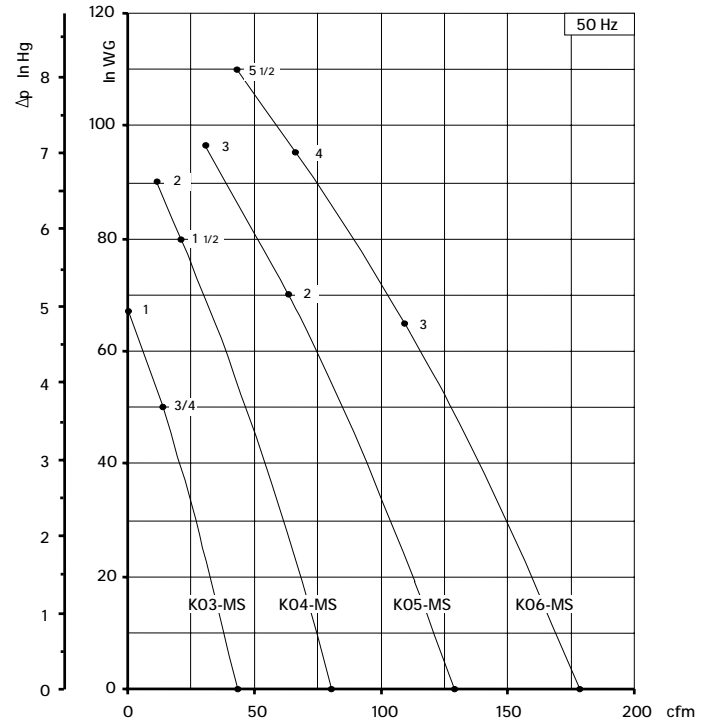
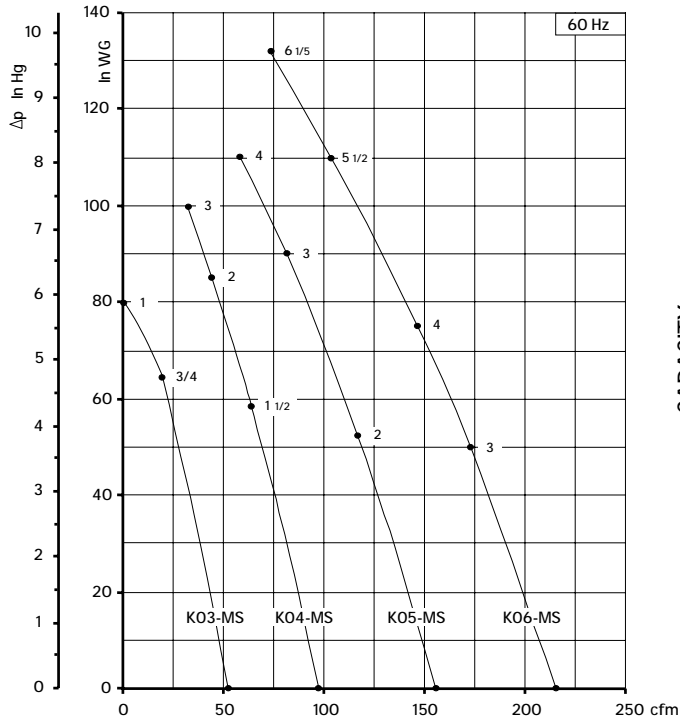

Curves refer to air at 68° F temperature, measured at inlet port and 29.92 In Hg atmospheric backpressure (abs).
 Values for flow, power consumption and temperature rise: +/-10% tolerance.
 Data subject to change without notice.

TECHNICAL CHARACTERISTICS

- Aluminium alloy construction
- Smooth operation
- High efficiency impeller
- Maintenance free
- Mountable in any position
- Recognized TEFC - cURus motor

OPTIONS

- Special voltages (IEC 38)
- Surface treatments

ACCESSORIES

- Inlet and/or inline filters
- Additional inlet/outlet silencers
- Safety valves
- Flow converting device
- Optional connectors

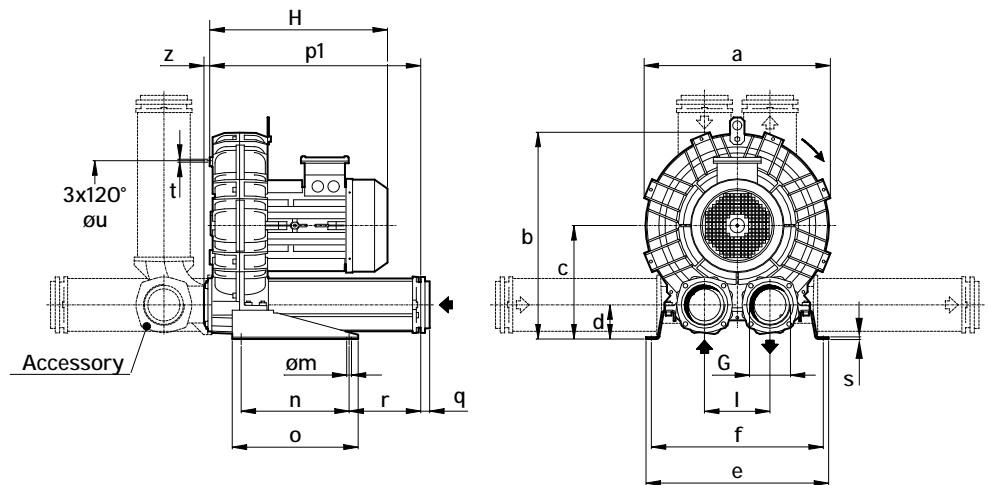

Dimensions in inches.

Dimension for reference only.

Model	a	b	c	d	e	f	G	l	m	n	o	p1	q	r	s	t	u	z
K07-MS	16.69	18.84	10.59	3.23	18.43	17.24	3" NPT	6.10	0.51	11.81	13.78	20.16	0.98	5.39	0.20	M8	11.61	0.63
K08-MS	17.99	19.61	10.59	3.23	18.82	17.64	3" NPT	6.10	0.51	11.81	13.78	20.16	0.98	5.39	0.20	M8	12.2	0.63
K09-MS	19.37	22.09	12.40	3.78	20.00	18.82	4" NPT	7.17	0.51	11.81	13.78	23.07	0.98	7.83	0.20	M8	14.17	0.63
K10-MS	20.31	22.56	12.40	3.78	20.00	18.82	4" NPT	7.17	0.51	11.81	13.78	23.07	0.98	7.83	0.20	M8	14.17	0.63
K11-MS	21.34	23.74	13.07	3.58	21.26	20.00	4" NPT	7.87	0.51	11.81	13.78	23.46	0.98	8.03	0.20	M8	15.35	0.63
K12-MS	21.57	23.82	13.07	3.58	21.26	20.00	4" NPT	7.87	0.51	11.81	13.78	23.58	0.98	8.03	0.20	M8	15.35	0.51

Model	Maximum flow cfm		Installed power Hp		Maximum differential pressure Dp (In Hg)		Noise level Lp dB (A) (1)		Overall dimensions H Inches	Weight Lbs
	60 Hz 3500 rpm	50 Hz 2900 rpm	60 Hz 3500 rpm	50 Hz 2900 rpm	60 Hz 3500 rpm	50 Hz 2900 rpm	60 Hz 3500 rpm	50 Hz 2900 rpm		
K07-MS	294	243	4	4	3.7	4.6	77.7	75.7	15.45	103.00
			5 ½	5 ½	5.6	6.3	78.0	76.0	15.45	107.10
			7 ½	7 ½	9.6	8.9	78.3	76.3	18.37	145.70
			10	-	11.1	-	78.6	-	18.37	154.50
K08-MS	381	316	5 ½	5 ½	2.9	3.8	78.8	76.8	15.45	115.70
			7 ½	7 ½	5.0	6.6	79.1	77.1	18.37	154.30
			10	10	8.5	9.2	79.4	77.4	18.37	163.10
			15	-	11.1	-	79.7	-	19.15	184.00
K09-MS	471	390	7 ½	7 ½	3.7	4.6	79.3	77.3	18.84	166.50
			10	10	5.9	7.0	79.6	77.6	18.84	175.10
			15	15	10.3	10.4	80.1	78.1	19.63	196.20
			20	-	11.1	-	80.4	-	23.74	269.00
K10-MS	556	460	7 ½	7 ½	2.7	3.8	79.4	77.4	18.84	170.90
			10	10	4.7	5.9	79.7	77.7	18.84	179.50
			15	15	8.8	9.9	80.2	78.2	19.63	200.60
			20	-	11.1	-	80.5	-	23.74	273.40
K11-MS	650	539	10	10	2.9	3.9	82.0	80.0	19.04	194.90
			15	15	6.0	7.1	82.5	80.5	19.83	216.00
			20	20	11.1	10.4	83.0	81.0	23.94	288.80
K12-MS	726	602	15	15	3.8	6.6	83.5	81.5	19.95	223.70
			20	20	6.3	9.6	84.3	82.3	24.06	296.50
			25	-	10.3	-	87.2	-	24.92	320.80

(1) Noise measured at 1 m distance with inlet and outlet ports piped, in accordance to ISO 3744.

- For proper use, the blower should be equipped with inlet filter and safety valve; other accessories available on request.

- Ambient temperature from +5° to +104°F.

- Specifications subject to change without notice.

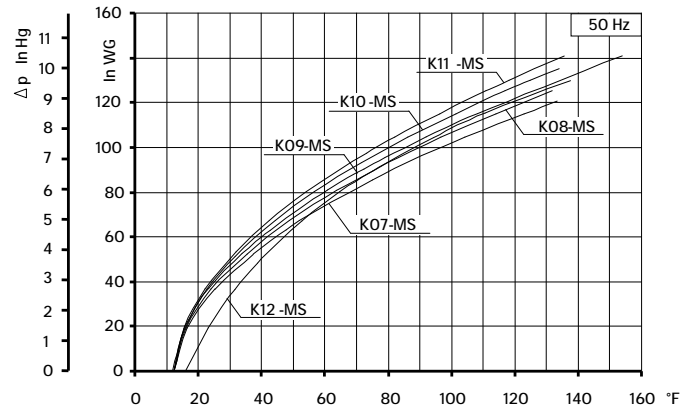
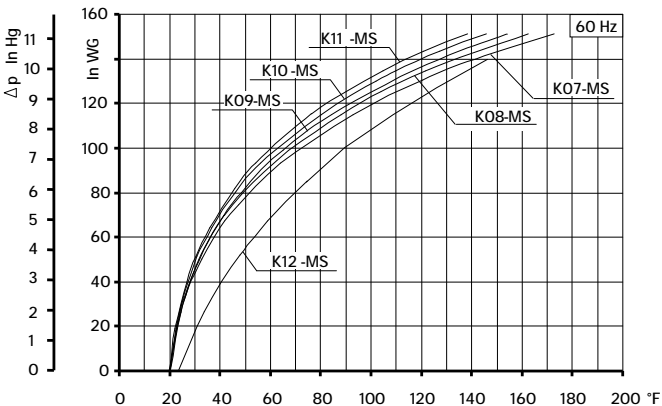
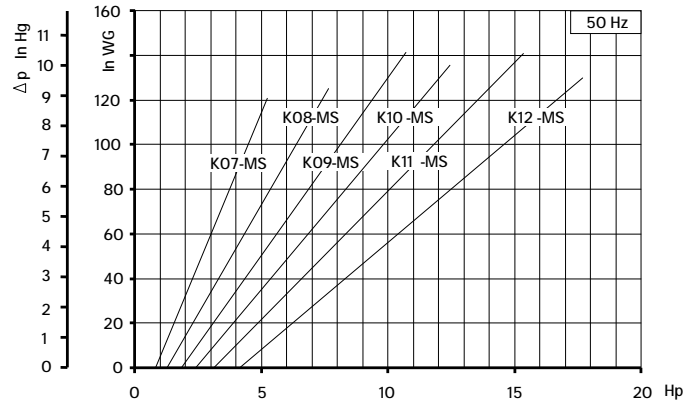
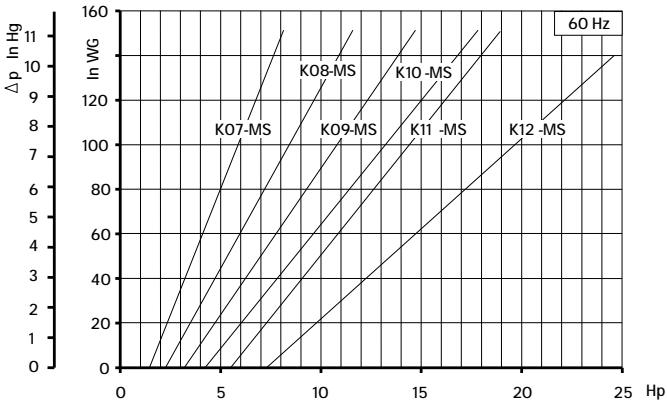
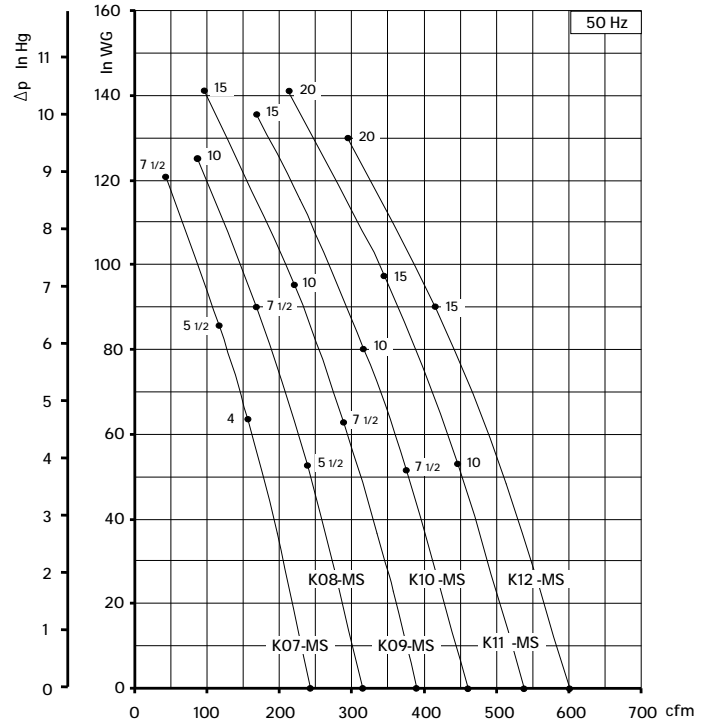
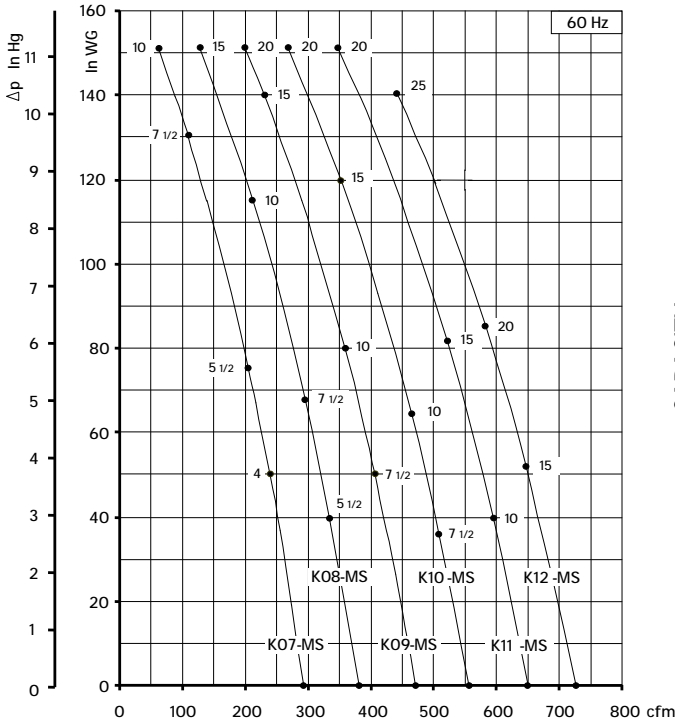

Curves refer to air at 68° F temperature, measured at inlet port and 29.92 In Hg atmospheric backpressure (abs).
 Values for flow, power consumption and temperature rise: +/-10% tolerance.
 Data subject to change without notice.

TECHNICAL CHARACTERISTICS

- Aluminium alloy construction
- Smooth operation
- High efficiency impeller
- Maintenance free
- Mountable in any position
- Recognized TEFC - cURus motor 3x120°øu

OPTIONS

- Special voltages (IEC 38)
- Surface treatments

ACCESSORIES

- Inlet and/or inline filters
- Additional inlet/outlet silencers
- Safety valves
- Flow converting device
- Optional connectors

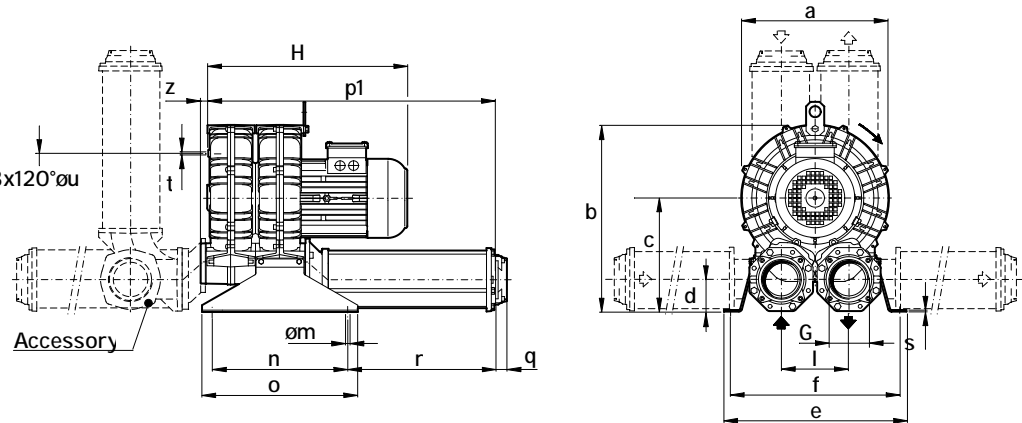

Dimensions in inches.

Dimension for reference only.

Model	a	b	c	d	e	f	G	l	m	n	o	p1	q	r	s	t	u	z
K05-TS	12.87	16.61	10.16	3.03	15.91	14.72	3" NPT	5.91	0.51	11.81	13.58	24.96	0.98	12.91	0.16	M8	7.87	0.75
K06-TS	14.80	17.72	10.31	2.95	15.91	14.72	3" NPT	6.10	0.51	11.81	13.58	26.06	0.98	13.19	0.16	M8	9.45	0.75

Model	Maximum flow cfm		Installed power Hp		Maximum differential pressure Δp (In Hg)		Noise level Lp dB (A) (1)		Overall dimensions H Inches	Weight Lbs
	60 Hz 3500 rpm	50 Hz 2900 rpm	60 Hz 3500 rpm	50 Hz 2900 rpm	60 Hz 3500 rpm	50 Hz 2900 rpm	60 Hz 3500 rpm	50 Hz 2900 rpm		
K05-TS	290	241	3	3	2.2	3.3	71.6	69.6	17.45	85.98
			4	4	3.4	5.1	73.1	71.1	18.64	89.29
			5 1/2	5 1/2	5.3	6.6	75.1	73.1	18.64	93.70
K06-TS	400	331	5 1/2	5 1/2	2.7	4.0	76.8	74.8	18.98	104.72
			7 1/2	7 1/2	4.0	4.8	77.1	75.1	22.60	141.09
			10	10	6.3	6.8	77.4	75.4	22.60	149.91

(1) Noise measured at 1 m distance with inlet and outlet ports piped, in accordance to ISO 3744.

- For proper use, the blower should be equipped with inlet filter and safety valve; other accessories available on request.
- Ambient temperature from +5° to +104°F.
- Specifications subject to change without notice.

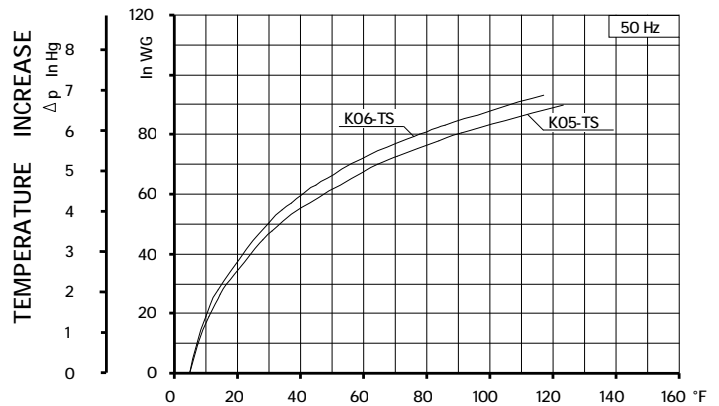
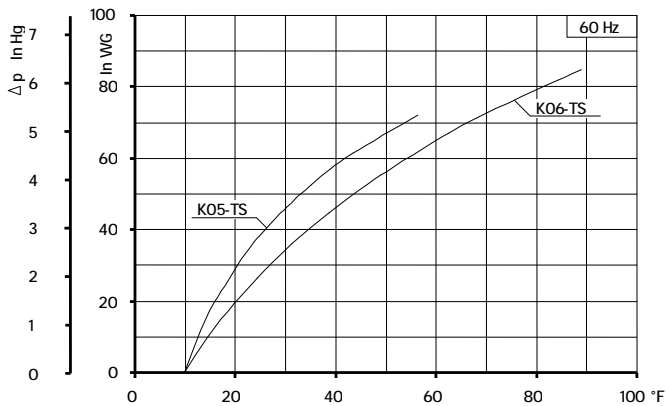
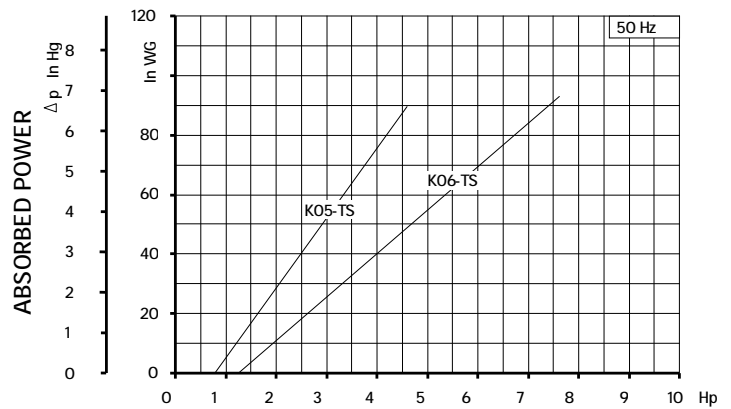
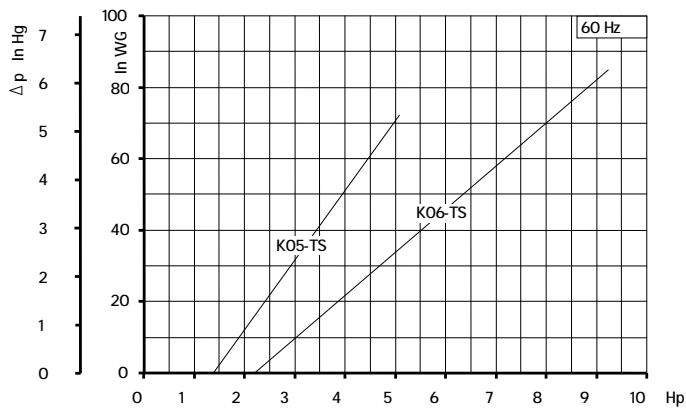
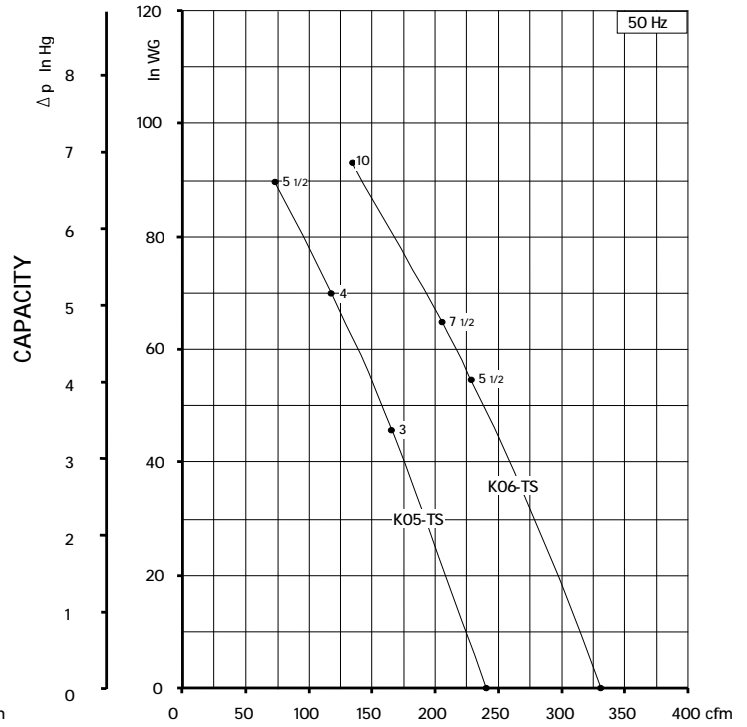
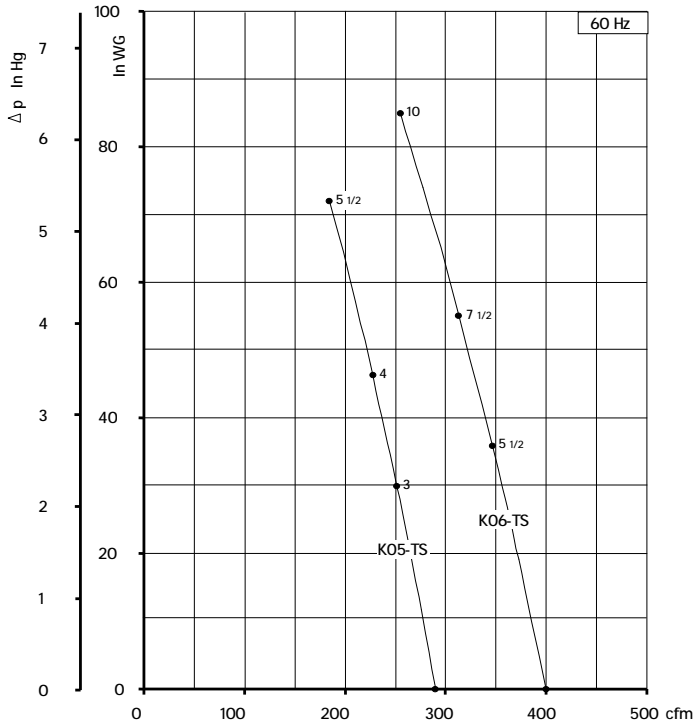

Curves refer to air at 68° F temperature, measured at inlet port and 29.92 In Hg atmospheric backpressure (abs).
 Values for flow, power consumption and temperature rise: +/- 10% tolerance.
 Data subject to change without notice.

TECHNICAL CHARACTERISTICS

- Aluminium alloy construction
- Smooth operation
- High efficiency impeller
- Maintenance free
- Mountable in any position
- Recognized TEFC - cURus motor
- G1/8" female thread on both suction and discharge silencer port flanges

OPTIONS

- Special voltages (IEC 38)
- Surface treatments

ACCESSORIES

- Inlet and/or inline filters
- Additional inlet/outlet silencers
- Safety valves
- Flow converting device
- Optional connectors

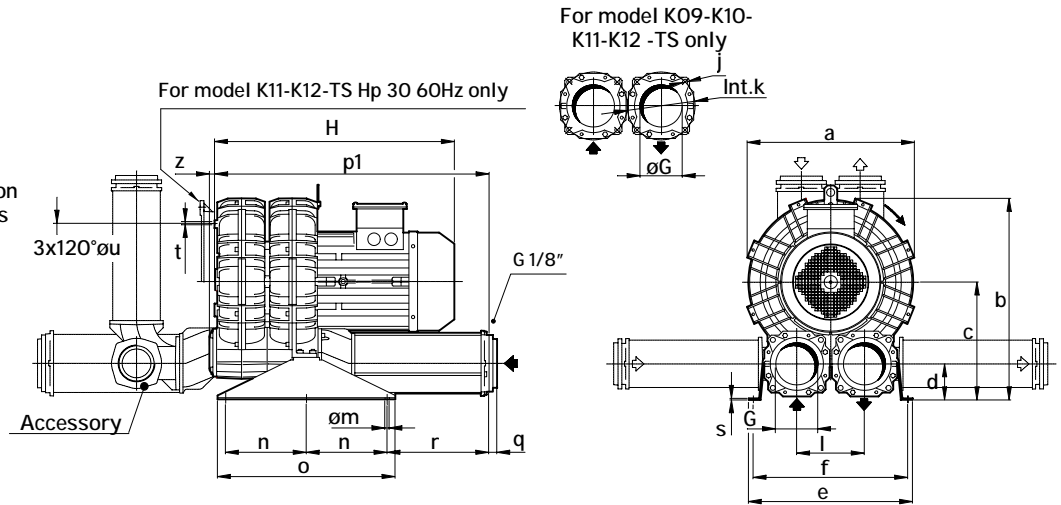

Dimensions in inches.

Dimension for reference only.

Model	a	b	c	d	e	f	G	l	j	k	m	n	o	p1	q	r	s	t	u	z
K07-TS	16.69	20.91	12.56	3.86	18.43	17.24	4"NPT	7.17	-	-	0.51	9.84	21.65	31.57	0.98	11.77	0.20	M8	11.61	0.63
K08-TS	18.03	21.57	12.56	3.86	18.82	17.64	4"NPT	7.17	-	-	0.51	9.84	21.65	31.57	0.98	11.77	0.20	M8	12.20	0.63
K09-TS	19.37	24.02	14.37	4.4	20.00	18.82	5.12	8.27	M16	8.27	0.51	9.84	21.65	33.46	-	12.40	0.20	M8	14.17	0.63
K10-TS	20.31	24.53	14.37	4.41	20.00	18.82	5.12	8.27	M16	8.27	0.51	9.84	21.65	33.46	-	12.40	0.20	M8	14.17	0.63
K11-TS	21.26	25.59	14.96	4.17	21.26	20.08	5.12	8.98	M16	8.27	0.51	9.84	21.65	34.25	-	12.60	0.20	M8	15.35	0.63
K12-TS	21.57	25.66	14.96	4.17	21.26	20.08	5.12	8.98	M16	8.27	0.51	9.84	21.65	34.37	-	12.60	0.20	M8	15.35	0.63

Model	Maximum flow cfm		Installed power Hp		Maximum differential pressure Δp (In Hg)		Noise level Lp dB (A) (1)		Overall dimensions H Inches	Weight Lbs
	60 Hz 3500 rpm	50 Hz 2900 rpm	60 Hz 3500 rpm	50 Hz 2900 rpm	60 Hz 3500 rpm	50 Hz 2900 rpm	60 Hz 3500 rpm	50 Hz 2900 rpm		
K07-TS	588	487	7 1/2	7 1/2	2.6	3.5	84.5	82.5	23.76	197.31
			10	10	4.4	5.2	84.8	82.8	23.76	206.13
			15	15	8.1	8.9	85.4	83.4	24.55	223.77
K08-TS	715	592	7 1/2	7 1/2	1.3	2.2	80.9	78.9	23.76	205.47
			10	10	2.7	3.7	81.2	79.2	23.76	214.29
			15	15	5.5	6.4	82.9	80.9	24.55	231.92
K09-TS	941	780	20	20	5.9	6.6	84.1	82.1	29.92	350.53
			25	25	8.1	8.8	86.1	84.1	30.79	383.60
K10-TS	1093	906	20	20	4.8	5.5	89.4	87.4	29.92	354.94
			25	25	5.9	7.0	89.7	87.7	30.79	388.01
K11-TS	1254	1039	25	25	3.7	5.0	90.7	88.7	31.38	429.02
			30 ⁽²⁾	30 ⁽²⁾	5.1	6.6	91.3	89.3	31.38	434.53
K12-TS	1410	1168	30 ⁽²⁾	30 ⁽²⁾	3.3	5.9	91.9	89.9	31.50	436.75

(1) Noise measured at 1 m distance with inlet and outlet ports piped, in accordance to ISO 3744.

(2) K11-K12-TS Hp 30 vertical assembly only.

- For proper use, the blower should be equipped with inlet filter and safety valve; other accessories available on request.
- Ambient temperature from +5° to +104°F.
- Specifications subject to change without notice.

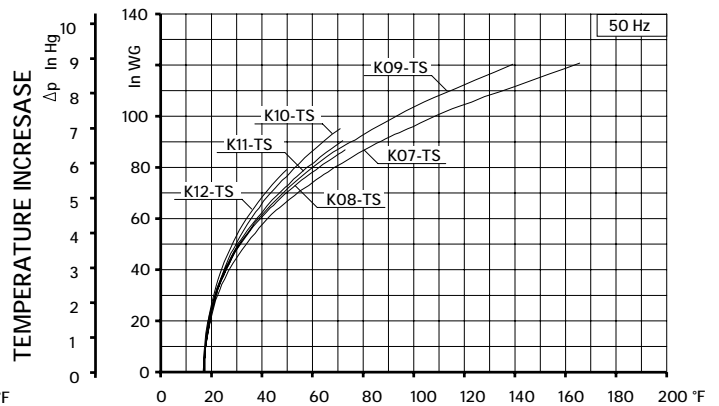
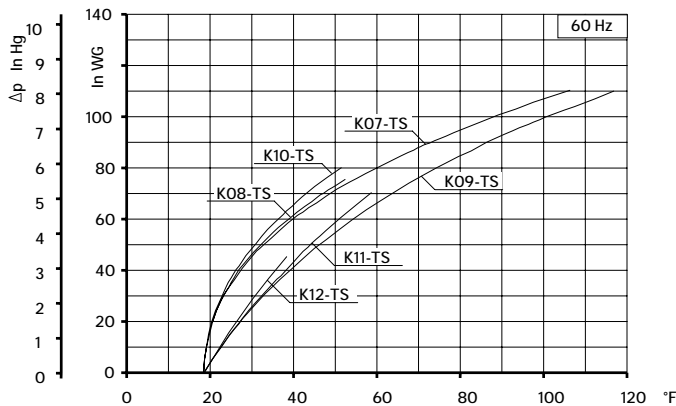
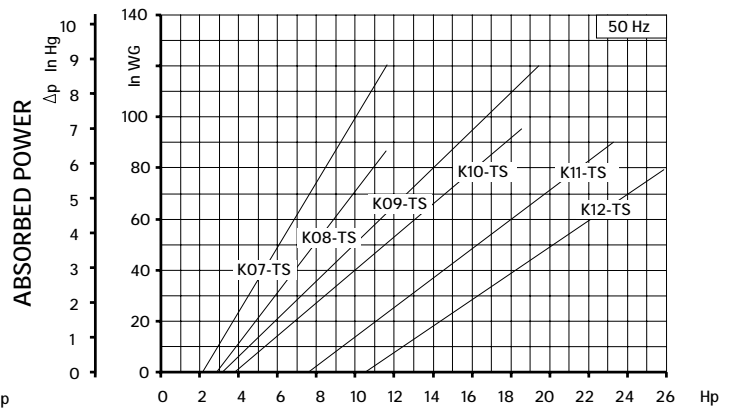
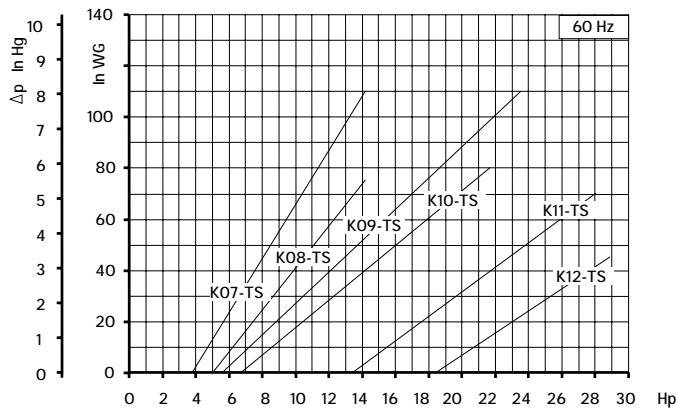
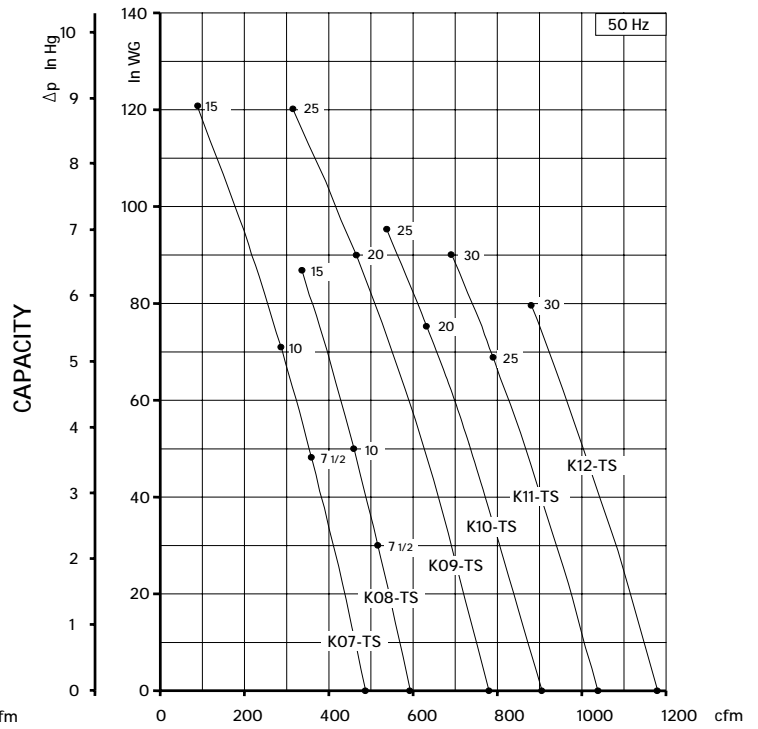
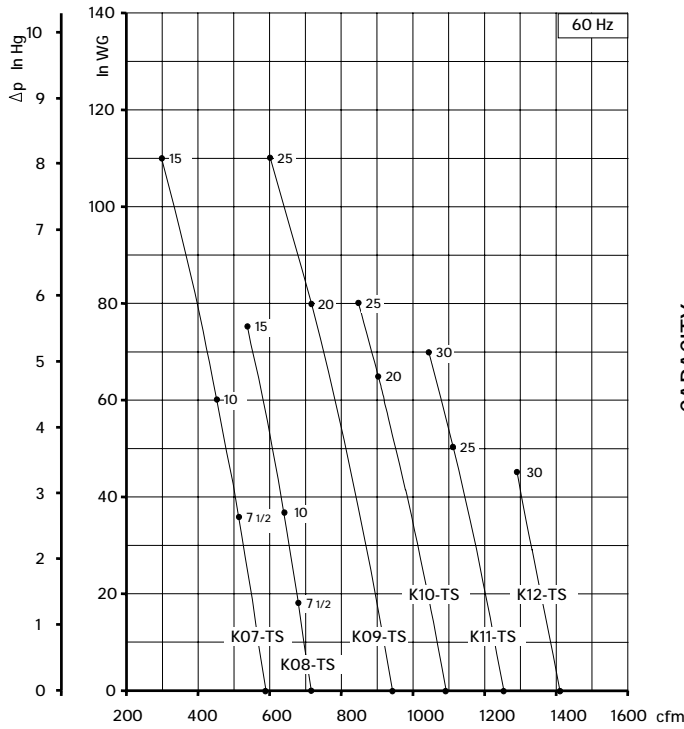

Curves refer to air at 68° F temperature, measured at inlet port and 29.92 In Hg atmospheric backpressure (abs).
Values for flow, power consumption and temperature rise: +/-10% tolerance.
Data subject to change without notice.

TECHNICAL CHARACTERISTICS

- Aluminium alloy construction
- Smooth operation
- High efficiency impeller
- Maintenance free
- Mountable in any position
- Recognized TEFC - cURus motor

OPTIONS

- Special voltages (IEC 38)
- Surface treatments

ACCESSORIES

- Inlet and/or inline filters
- Additional inlet/outlet silencers
- Safety valves
- Flow converting device
- Optional connectors

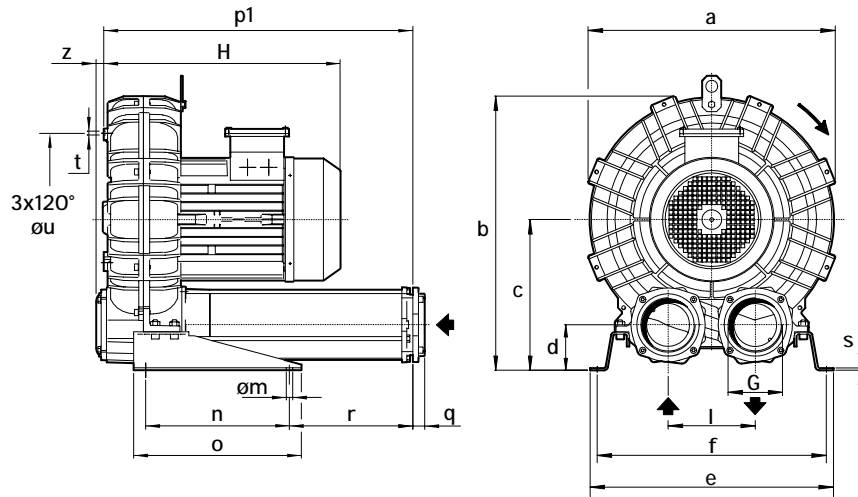

Dimensions in inches.
Dimension for reference only.

Model	a	b	c	d	e	f	G	l	m	n	o	p1	q	r	s	t	u	z
K07R-MD	16.69	18.94	10.59	3.23	18.43	17.24	2" NPT	6.10	0.51	11.81	13.78	16.46	0.71	1.7	0.20	M8	11.61	0.63
K08R-MD	17.99	19.61	10.59	3.23	18.82	17.64	2" NPT	6.10	0.51	11.81	13.78	16.46	0.71	1.7	0.20	M8	12.20	0.63
K09-MD	19.37	22.09	12.40	3.78	20.00	18.82	4" NPT	7.17	0.51	11.81	13.78	25.35	0.98	10.12	0.20	M8	14.17	0.63
K10-MD	20.31	22.56	12.40	3.78	20.00	18.82	4" NPT	7.17	0.51	11.81	13.78	25.35	0.98	10.12	0.20	M8	14.17	0.63
K11-MD	21.35	23.74	13.07	3.58	21.18	20.00	4" NPT	7.87	0.51	11.81	13.78	25.75	0.98	10.12	0.20	M8	14.17	0.63
K12-MD	21.57	23.85	13.07	3.58	21.18	20.00	4" NPT	7.87	0.51	11.81	13.78	25.87	0.98	10.31	0.20	M8	15.35	0.52

Model	Maximum flow cfm		Installed power Hp		Maximum differential pressure Dp (In Hg)		Noise level Lp dB (A) (1)		Overall dimensions H Inches	Weight Lbs
	60 Hz 3500 rpm	50 Hz 2900 rpm	60 Hz 3500 rpm	50 Hz 2900 rpm	60 Hz 3500 rpm	50 Hz 2900 rpm	60 Hz 3500 rpm	50 Hz 2900 rpm		
K07R-MD	129	107	3	3	5.0	6.4	72.5	70.5	16.14	101.40
			4	4	8.1	9.4	73.0	71.0	16.14	103.60
			5 1/2	5 1/2	11.0	12.5	73.5	71.5	16.14	111.50
			7 1/2	-	13.2	-	74.0	-	17.52	134.50
K08R-MD	168	139	5 1/2	5 1/2	6.3	8.1	75.7	73.7	16.14	116.90
			7 1/2	7 1/2	11.9	13.2	76.1	74.1	17.52	140.00
			10	-	13.2	-	76.4	-	17.52	151.00
K09-MD	221	183	5 1/2	5 1/2	4.0	5.7	76.4	74.4	16.54	144.40
			7 1/2	7 1/2	8.8	10.5	77.5	75.5	17.95	167.60
			10	10	14.0	14.0	79.0	77.0	17.95	178.60
K10-MD	275	228	7 1/2	7 1/2	6.3	8.1	80.4	78.4	17.91	170.90
			10	10	10.3	12.1	80.7	78.7	17.91	181.90
			15	15	14.7	14.7	81.3	79.3	19.29	203.90
K11-MD	306	254	10	10	7.4	9.2	80.7	78.7	18.11	211.60
			15	15	14.0	14.7	81.3	79.3	19.49	232.60
			20	-	14.7	-	81.6	-	23.23	287.20
K12-MD	336	278	15	15	7.4	13.2	82.2	80.2	19.61	240.30
			20	-	13.2	-	82.5	-	23.42	295.00

(1) Noise measured at 1 m distance with inlet and outlet ports piped, in accordance to ISO 3744.

- For proper use, the blower should be equipped with inlet filter and safety valve; other accessories available on request.
- Ambient temperature from +5° to +104°F.
- Specifications subject to change without notice.

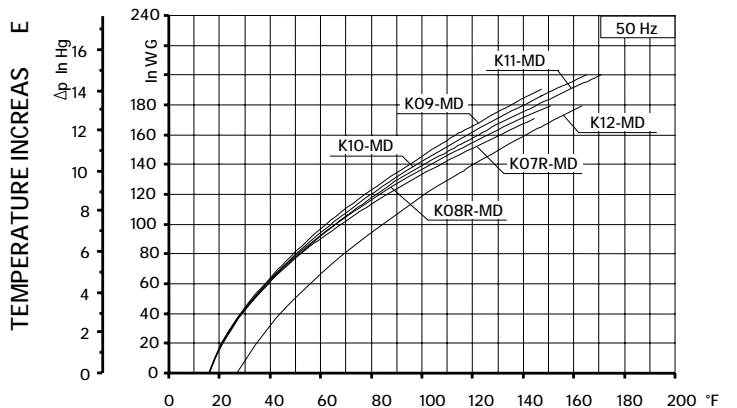
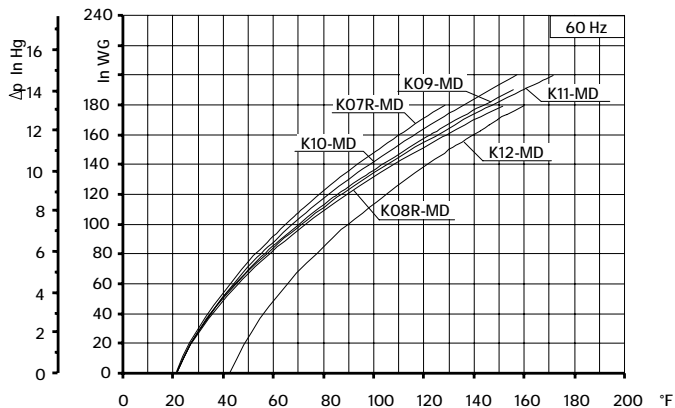
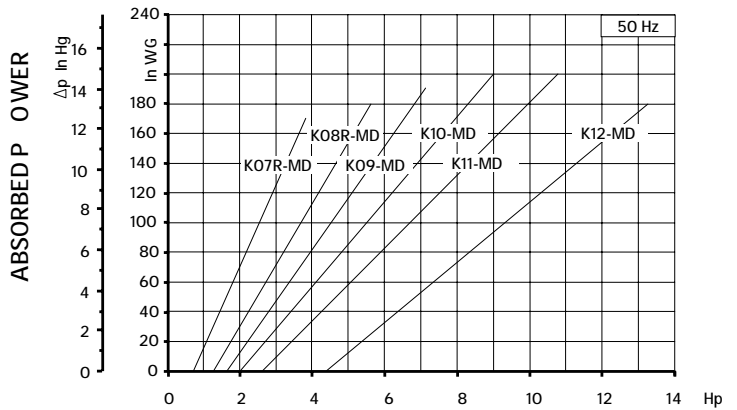
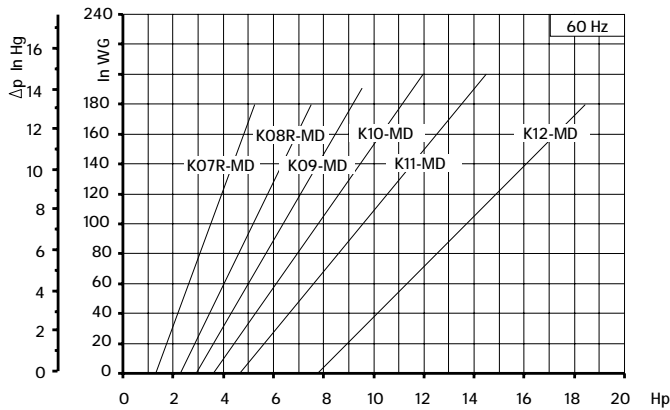
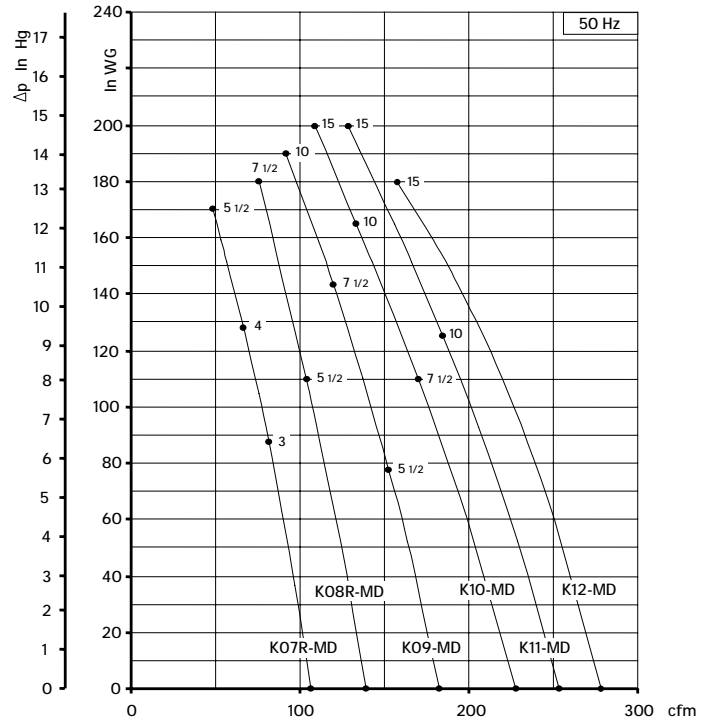
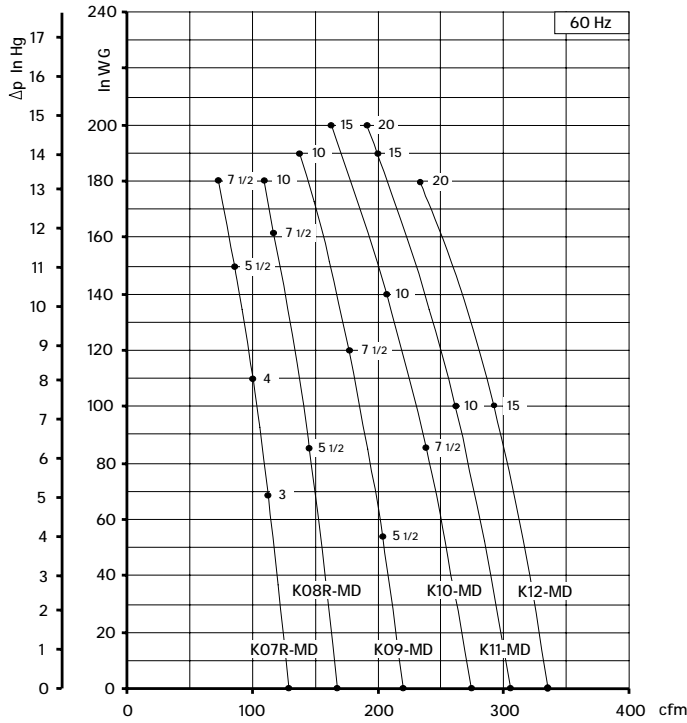

Curves refer to air at 68° F temperature, measured at inlet port and 29.92 In Hg atmospheric backpressure (abs).
Values for flow, power consumption and temperature rise: +/-10% tolerance.
Data subject to change without notice.

TECHNICAL CHARACTERISTICS

- Aluminium alloy construction
- Smooth operation
- High efficiency impeller
- Maintenance free
- Mountable in any position
- Recognized TEFC - cURus motor

OPTIONS

- Special voltages (IEC 38)
- Surface treatments

ACCESSORIES

- Inlet and/or inline filters
- Additional inlet/outlet silencers
- Safety valves
- Flow converting device
- Optional connectors

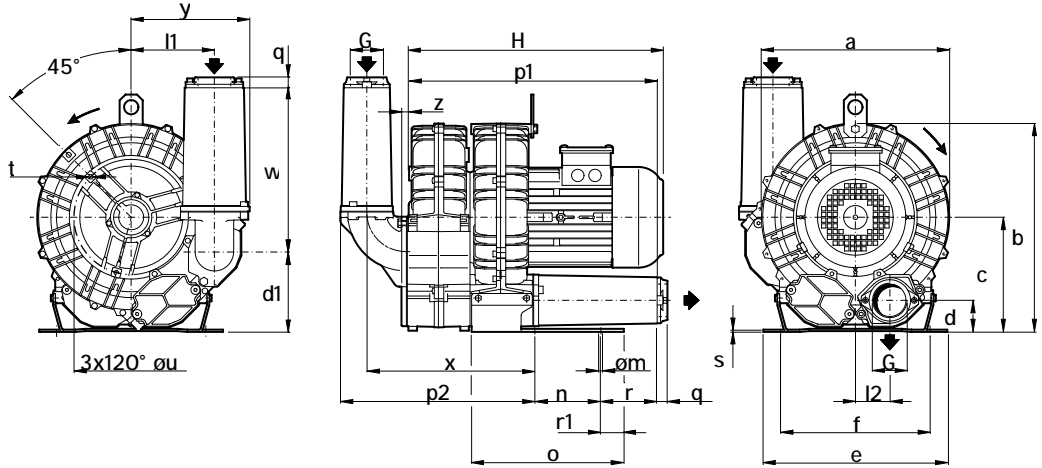

Dimensions in inches.
 Dimension for reference only.

Model	a	b	c	d	d1	e	f	G	l1	l2	m	n	o	p1	p2	q	r	r1	s	t	u	w	x	y	z
K04-TD	11.22	12.40	6.77	1.93	4.76	10.04	8.86	1" 1/2 NPT	4.84	2.01	0.47	3.74	6.73	12.44	10.00	0.71	2.76	0.59	0.16	M6	6.89	7.40	8.43	6.81	0.71
K05-TD	12.87	14.37	7.87	2.13	5.51	12.60	10.24	2" NPT	5.71	2.36	0.59	4.53	10.43	16.85	13.39	0.71	3.86	1.57	0.16	M8	7.87	11.26	11.54	8.11	0.75
K06-TD	14.80	16.54	9.13	2.32	6.69	12.80	11.42	2" NPT	5.94	2.87	0.59	5.51	10.43	19.92	13.94	0.71	5.35	0.75	0.16	M8	9.45	11.26	12.13	8.27	0.75

Model	Maximum flow cfm		Installed power Hp		Maximum differential pressure Δp (In Hg)		Noise level Lp dB (A) (1)		Overall dimensions H Inches	Weight Lbs
	60 Hz 3500 rpm	50 Hz 2900 rpm	60 Hz 3500 rpm	50 Hz 2900 rpm	60 Hz 3500 rpm	50 Hz 2900 rpm	60 Hz 3500 rpm	50 Hz 2900 rpm		
K04-TD	99	82	2	2	5.1	7.0	70.6	68.6	17.26	62.83
			3	3	8.8	8.1	71.6	69.6	17.26	69.44
K05-TD	153	127	3	3	5.1	7.0	72.6	70.6	17.45	84.88
			4	4	7.7	9.9	74.1	72.1	18.64	88.18
			5 1/2	5 1/2	11.0	11.8	75.6	73.6	18.64	92.59
K06-TD	222	184	5 1/2	5 1/2	5.9	8.8	74.6	72.6	18.98	103.62
			7 1/2	7 1/2	9.2	10.3	75.6	73.6	22.60	139.99
			10	10	11.8	11.8	76.6	74.4	22.60	148.81

(1) Noise measured at 1 m distance with inlet and outlet ports piped, in accordance to ISO 3744.

- For proper use, the blower should be equipped with inlet filter and safety valve; other accessories available on request.
- Ambient temperature from +5° to +104°F.
- Specifications subject to change without notice.

SCL K04 / K05 / K06

TD SERIES

SN 1936-6 2/2

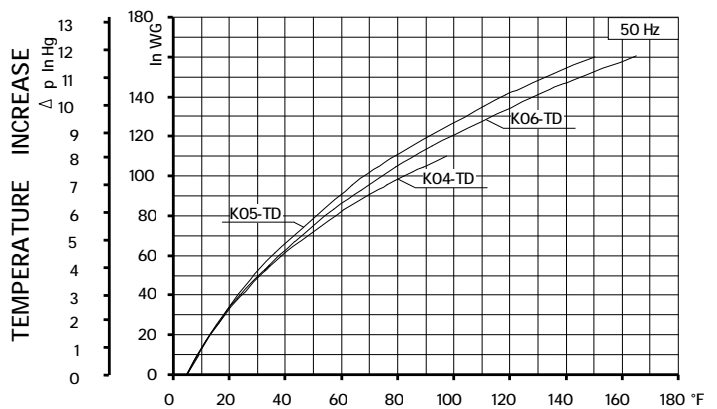
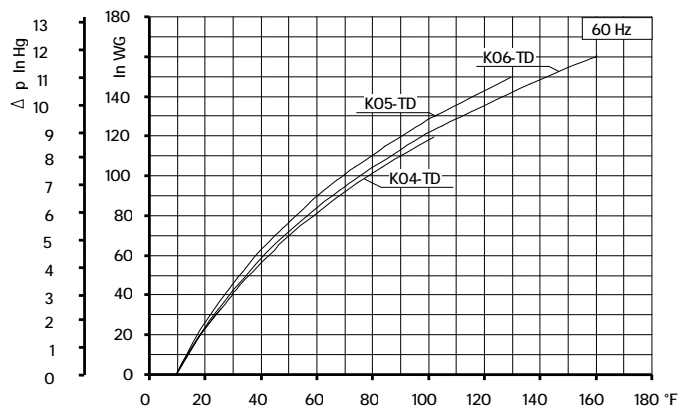
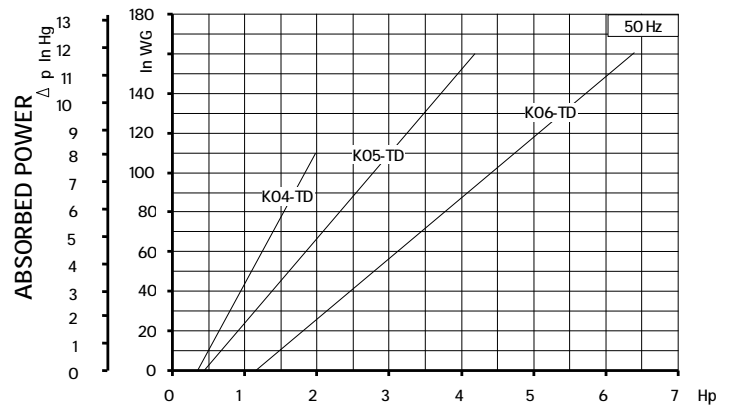
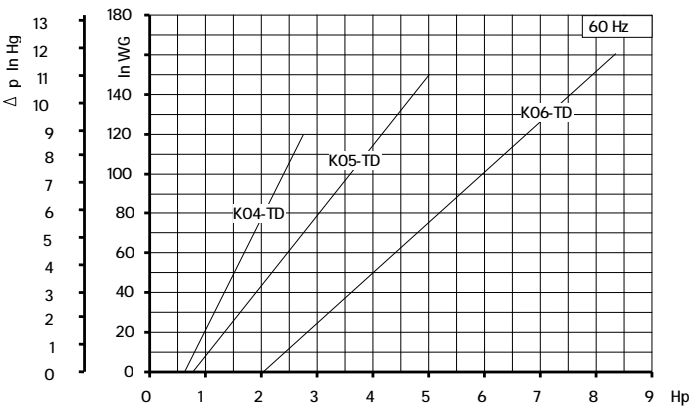
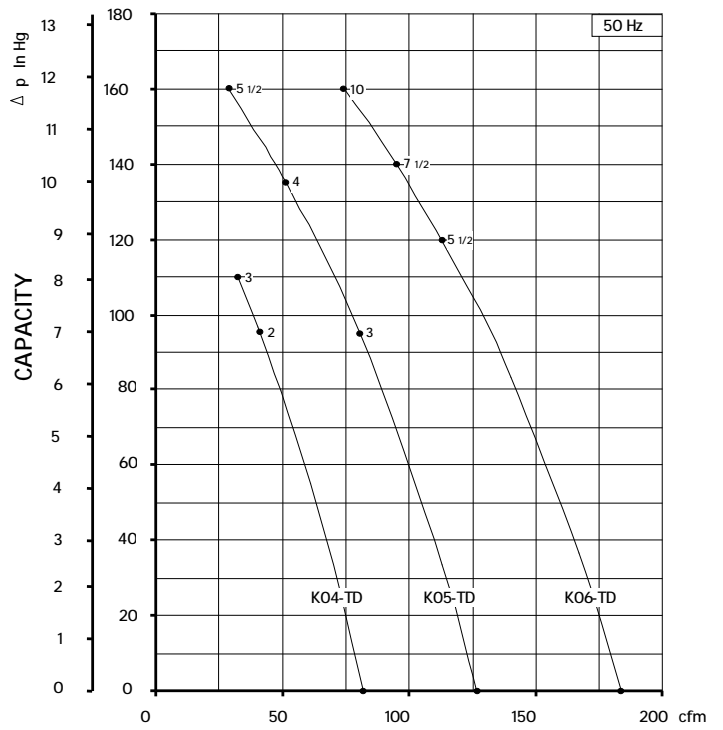
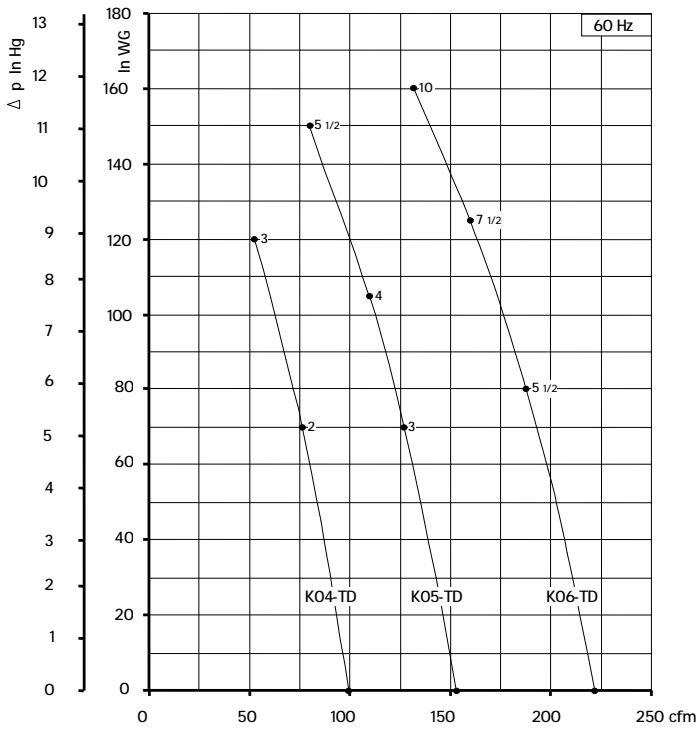

Curves refer to air at 68° F temperature, measured at inlet port and 29.92 In Hg atmospheric backpressure (abs).
Values for flow, power consumption and temperature rise: +/-10% tolerance.
Data subject to change without notice.

TECHNICAL CHARACTERISTICS

- Aluminium alloy construction
- Smooth operation
- High efficiency impeller
- Maintenance free
- Mountable in any position
- Recognized TEFC - cURus motor
- G1/8" female thread on both suction and discharge silencer port flanges

OPTIONS

- Special voltages (IEC 38)
- Surface treatments

ACCESSORIES

- Inlet and/or inline filters
- Additional inlet/outlet silencers
- Safety valves
- Flow converting device
- Optional connectors

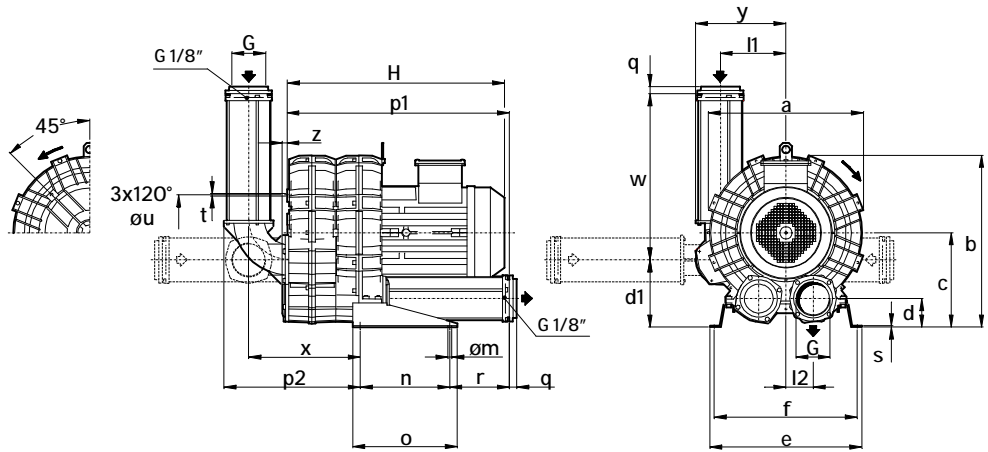

Dimensions in inches.

Dimension for reference only.

Model	a	b	c	d	d1	e	f	G	l1	l2	m	n	o	p1	p2	q	r	s	t	u	w	x	y	z
K07-TD	16.69	18.94	10.59	3.23	7.56	18.43	17.24	3"NPT	7.36	3.05	0.51	11.81	13.78	25.55	15.43	0.98	5.39	0.20	M8	11.61	18.94	12.56	10.24	0.63
K08-TD	17.99	19.61	10.59	3.23	7.56	18.82	17.64	3"NPT	7.36	3.05	0.51	11.81	13.78	25.55	15.43	0.98	5.39	0.20	M8	12.20	18.94	12.56	10.24	0.63
K09-TD	19.37	22.09	12.4	3.78	8.86	20.0	18.82	4"NPT	8.66	3.58	0.51	11.81	13.78	29.33	17.91	0.98	7.83	0.20	M8	14.17	21.89	14.65	11.89	0.63
K10-TD	20.31	22.56	12.4	3.78	8.86	20.0	8.82	4"NPT	8.66	3.58	0.51	11.81	13.78	29.33	17.91	0.98	7.83	0.20	M8	14.17	21.89	14.65	11.89	0.63
K11 -TD	21.26	23.70	13.07	3.54	9.13	21.18	20.0	4"NPT	9.53	3.94	0.51	11.81	13.78	30.12	18.50	0.98	8.03	0.20	M8	15.35	21.89	15.24	12.76	0.63
K12-TD	21.57	23.81	13.07	3.54	9.13	21.18	20.0	4"NPT	9.53	3.94	0.51	11.81	13.78	30.23	18.50	0.98	8.03	0.20	M8	15.35	21.89	15.24	12.76	0.63

Model	Maximum flow cfm		Installed power Hp		Maximum differential pressure Δp (In Hg)		Noise level Lp dB (A) (1)		Overall dimensions H Inches	Weight Lbs
	60 Hz 3500 rpm	50 Hz 2900 rpm	60 Hz 3500 rpm	50 Hz 2900 rpm	60 Hz 3500 rpm	50 Hz 2900 rpm	60 Hz 3500 rpm	50 Hz 2900 rpm		
	K07-TD	296	245	7 1/2	7 1/2	6.6	7.7	78.6	76.6	23.76
10	10			9.9	11.0	78.9	76.9	23.76	202.8	
15	15			13.2	12.6	79.5	77.5	24.55	220.5	
K08-TD	368	305	7 1/2	7 1/2	4.3	5.5	79.0	77.0	23.76	202.2
10			10	7.0	8.1	79.3	77.3	23.76	211.0	
15			15	12.5	13.6	79.9	77.9	24.55	228.6	
K09-TD	467	387	15	15	7.7	9.2	82.2	80.2	25.81	222.7
20			20	11.7	13.2	82.5	80.5	29.92	347.2	
25			-	14.0	-	82.8	-	30.79	380.3	
K10-TD	571	473	15	15	6.3	7.4	85.9	83.9	25.81	271.2
20			20	9.6	11.0	86.2	84.2	29.92	351.6	
25			25	13.2	14.7	86.5	84.5	30.79	384.7	
K11-TD	642	532	20	20	6.6	8.5	86.7	84.7	31.38	392.6
25			25	9.6	11.4	87.2	85.2	31.38	425.7	
K12-TD	716	593	25	25	6.3	10.3	87.5	85.5	31.50	423.5
30			30	8.8	14.0	88.0	86.0	31.50	429.0	

(1) Noise measured at 1 m distance with inlet and outlet ports piped, in accordance to ISO 3744.

- For proper use, the blower should be equipped with inlet filter and safety valve; other accessories available on request.
- Ambient temperature from +5° to +104°F.
- Specifications subject to change without notice.

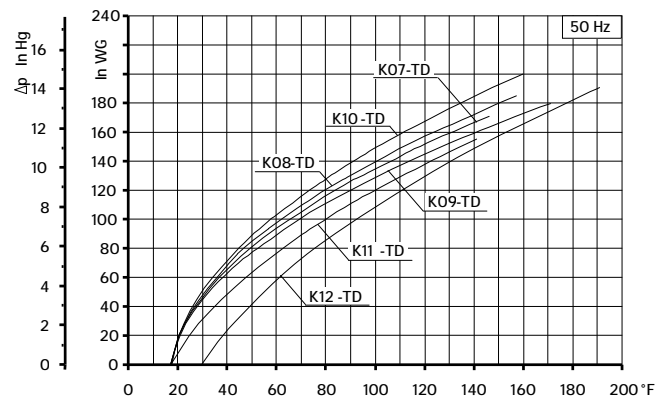
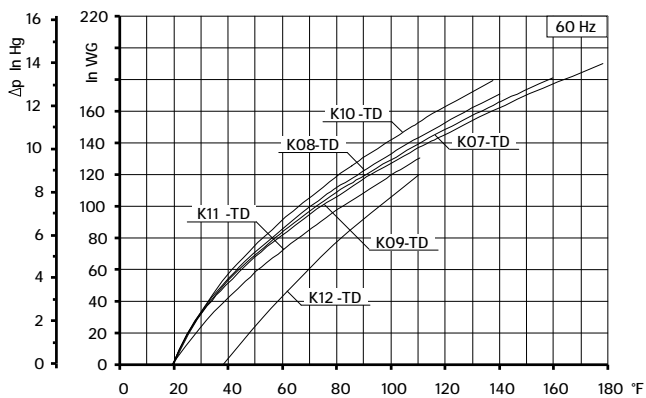
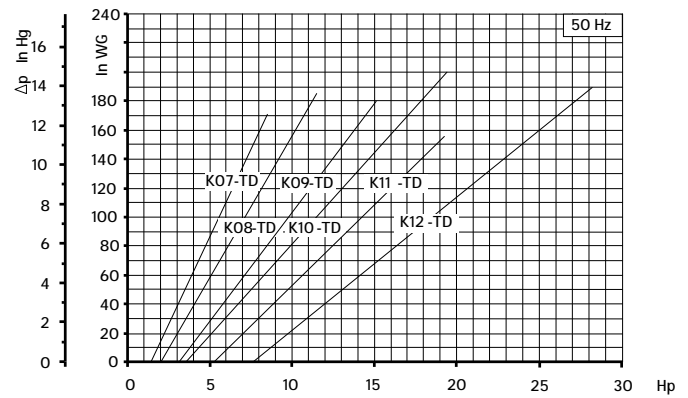
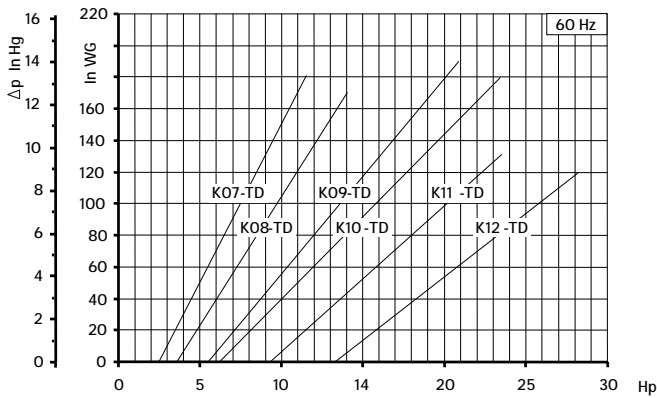
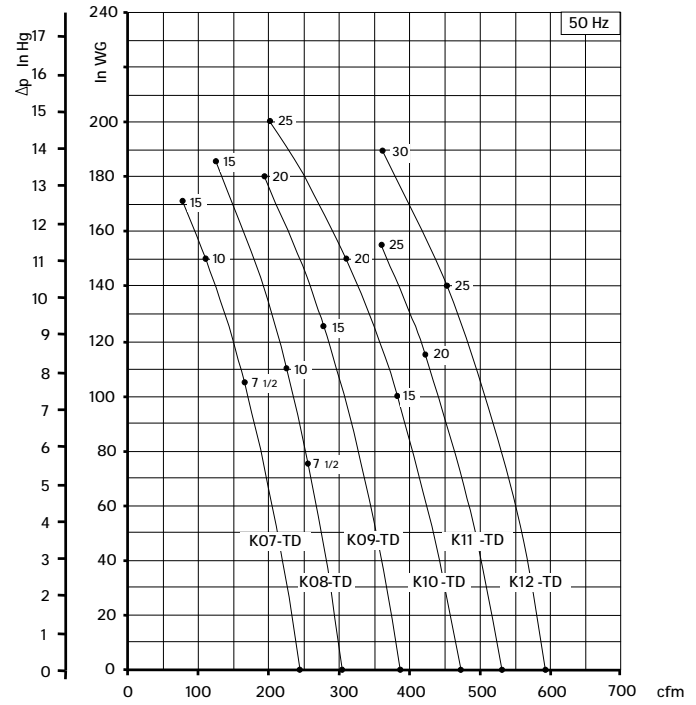
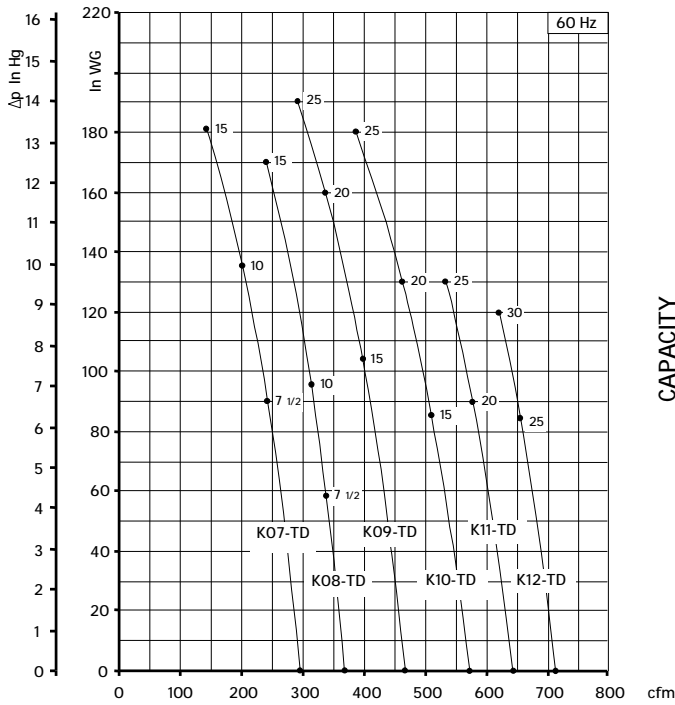

Curves refer to air at 68°F temperature, measured at inlet port and 29.92 In Hg atmospheric backpressure (abs).
Values for flow, power consumption and temperature rise +/-10% tolerance.
Data subject to change without notice.

STANDARD FEATURES

- Low weight cast aluminum construction.
- Quiet operation with integral inlet and outlet muffling.
- Recognized TEFC - cURus motor.
- High efficiency / low noise impeller design.
- No lubrication / maintenance required.
- Allowed ambient: +5 °F to +104 °F.
- Mountable in any plane.

OPTIONS

- Special voltages.
- Surface treatment or plating.
- Gas tight sealing.
- Special designs available.

ACCESSORIES

- Inlet and/or inline filters.
- Additional inlet/outlet silencers.
- Safety valves.
- Flow converting devices.
- Optional connectors

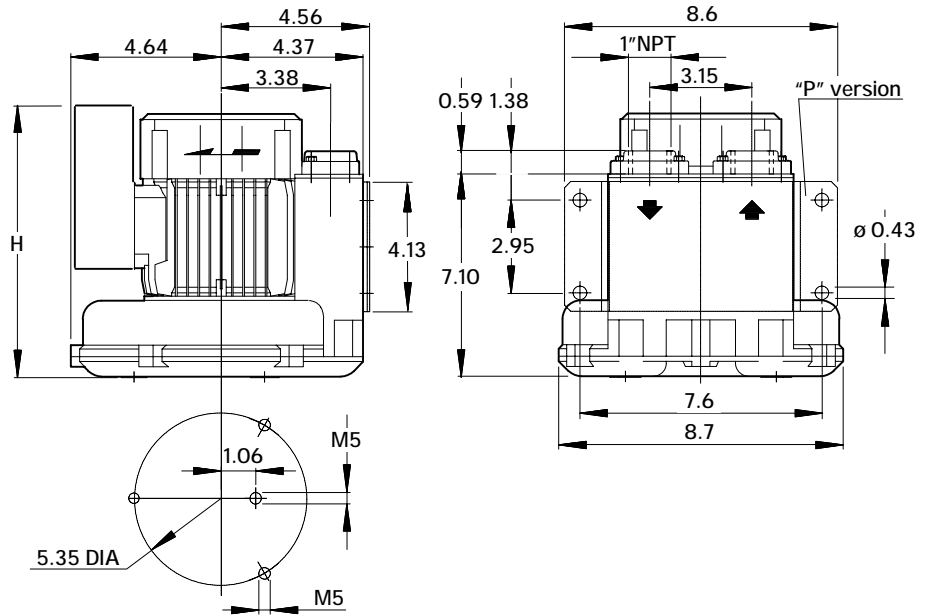

Dimensions in inches.
 Dimension for reference only.

Model	Maximum flow cfm		Installed power Hp		Maximum differential pressure Δp (In Hg)		Noise level Lp dB (A) (1)		Overall dimensions H Inches	Weight Lbs
	60 Hz 3500 rpm	50 Hz 2900 rpm	60 Hz 3500 rpm	50 Hz 2900 rpm	60 Hz 3500 rpm	50 Hz 2900 rpm	60 Hz 3500 rpm	50 Hz 2900 rpm		
06	39	32	1/3	-	2.7	-	58.7	-	10.60	18.30
			1/2	1/2	3.5	2.4	59.0	58.0	10.60	18.50

(1) Noise measured at 1 m distance with inlet and outlet ports piped, in accordance to ISO 3744.

- For proper use, the blower should be equipped with inlet filter and safety valve; other accessories available on request.
- Ambient temperature from +5° to +104°F.
- Specifications subject to change without notice.

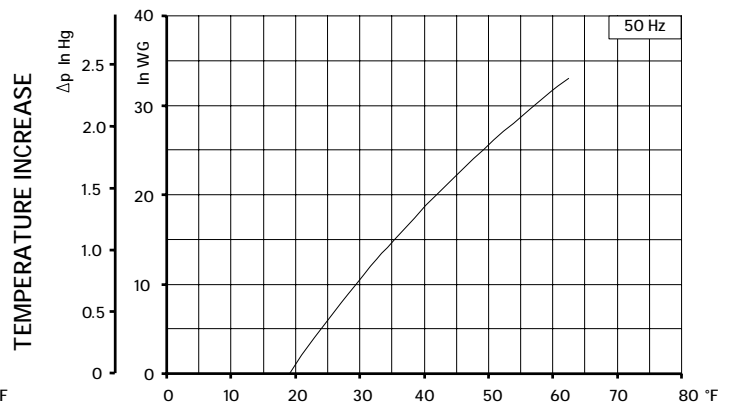
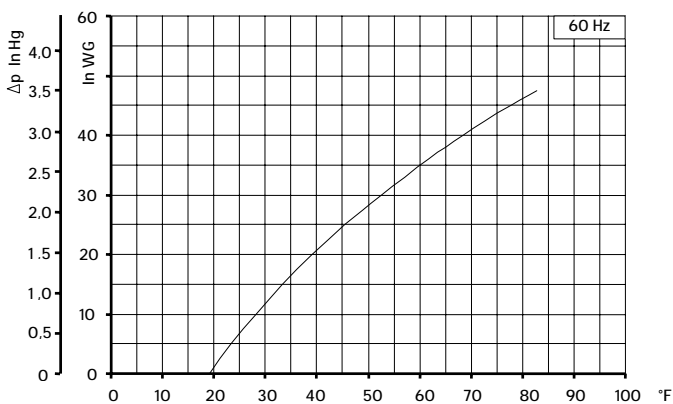
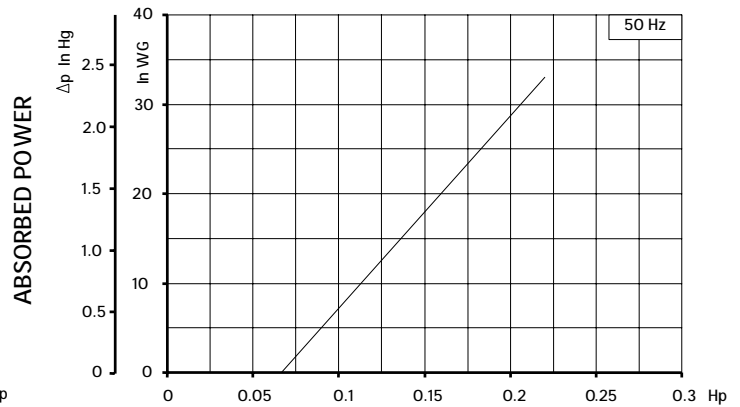
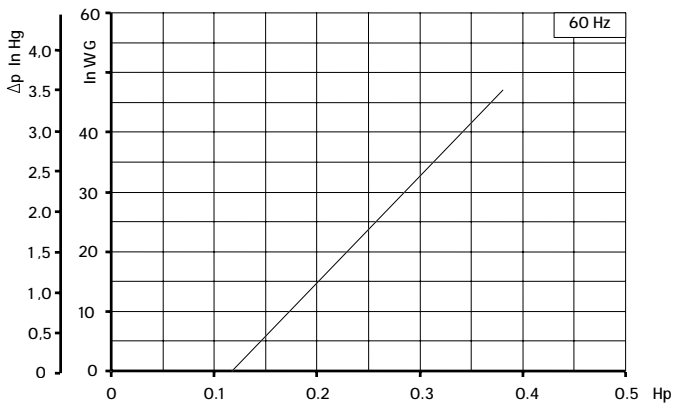
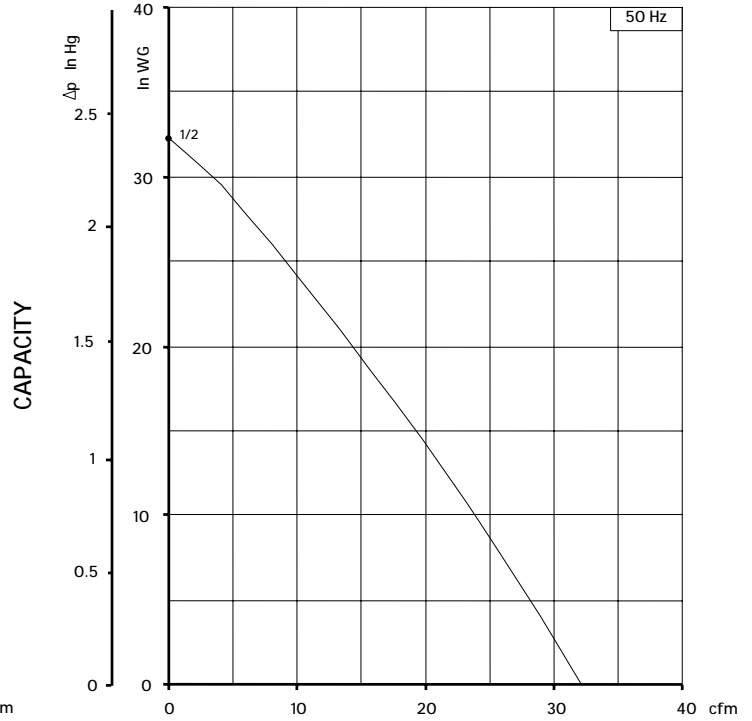
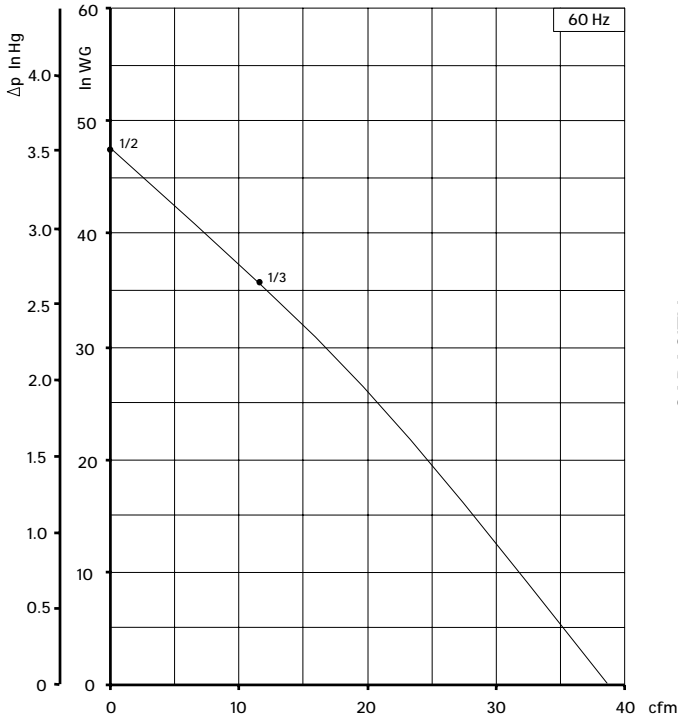

Curves refer to air at 68° F temperature, measured at inlet port and 29.92 In Hg atmospheric backpressure (abs).
Values for flow, power consumption and temperature rise: +/-10% tolerance.
Data subject to change without notice.

STANDARD FEATURES

- Low weight cast aluminum construction.
- Quiet operation with integral inlet and outlet muffling.
- Recognized TEFC - cURus motor.
- High efficiency / low noise impeller design.
- No lubrication / maintenance required.
- Allowed ambient: +5 °F to +104 °F.
- Mountable in any plane.

OPTIONS

- Remote drive models (belt or coupling).
- Special voltages.
- Surface treatment or plating.
- Gas tight sealing.
- Special designs available.

ACCESSORIES

- Inlet and/or inline filters.
- Additional inlet/outlet silencers.
- Safety valves.
- Flow converting devices.
- Optionals connectors

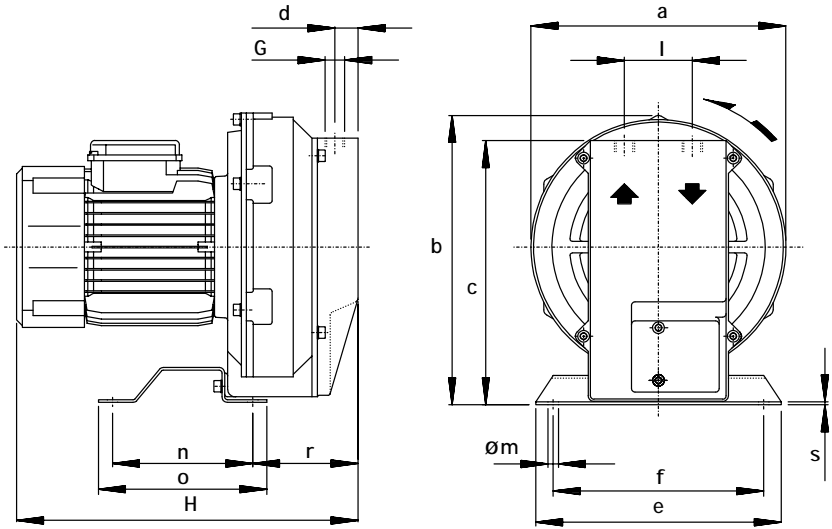

Dimensions in inches.
 Dimension for reference only.

Model	a	b	c	d	e	f	G	l	m	n	o	r	s
10DL	8.66	10.08	9.06	0.91	8.27	7.09	1/2" NPT	2.28	0.35	4.72	5.67	3.54	0.10
15DH	9.84	11.26	0.16 1	1.18	8.27	7.09	3/4" NPT	2.52	0.35	4.72	5.67	4.72	0.10

Model	Maximum flow cfm		Installed power Hp		Maximum differential pressure Δp (In Hg)		Noise level Lp dB (A) (1)		Overall dimensions H Inches	Weight Lbs
	60 Hz 3500 rpm	50 Hz 2900 rpm	60 Hz 3500 rpm	50 Hz 2900 rpm	60 Hz 3500 rpm	50 Hz 2900 rpm	60 Hz 3500 rpm	50 Hz 2900 rpm		
10DL	21	18	1/3	1/3	4.4	4.4	63.7	61.7	12.20	21.80
			1/2	1/2	6.3	4.9	64.0	62.0	12.76	23.50
15DH	35	29	3/4	3/4	7.2	7.7	63.7	61.7	14.25	32.50
			1	1	8.1	8.1	64.0	62.0	15.75	40.00

(1) Noise measured at 1 m distance with inlet and outlet ports piped, in accordance to ISO 3744.

- For proper use, the blower should be equipped with inlet filter and safety valve; other accessories available on request.
- Ambient temperature from +5° to +104°F.
- Specifications subject to change without notice.

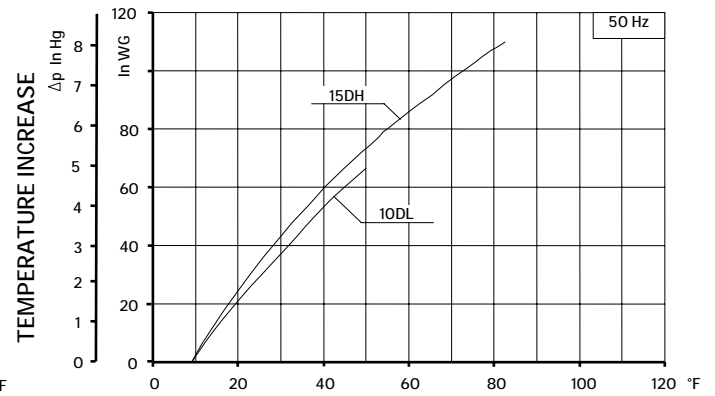
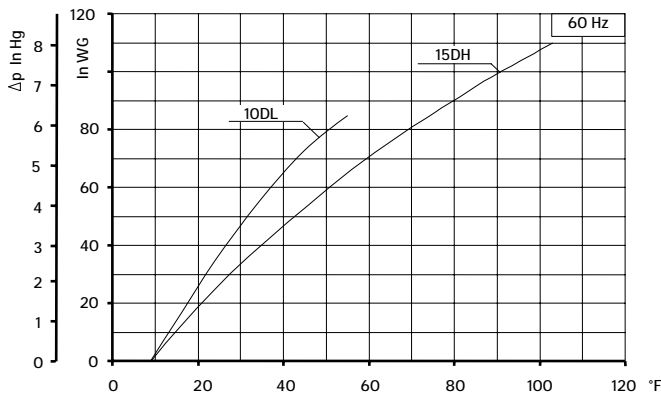
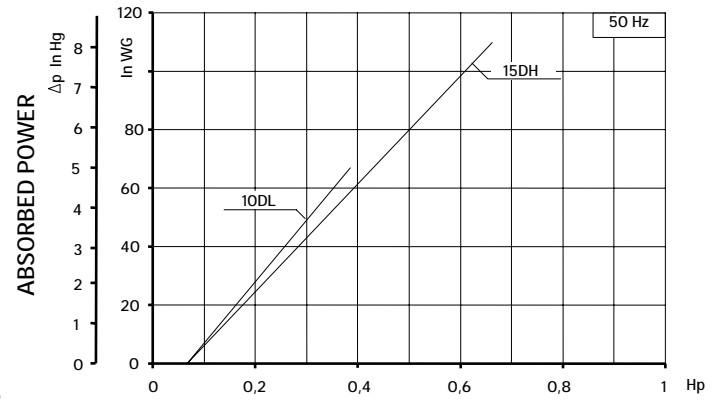
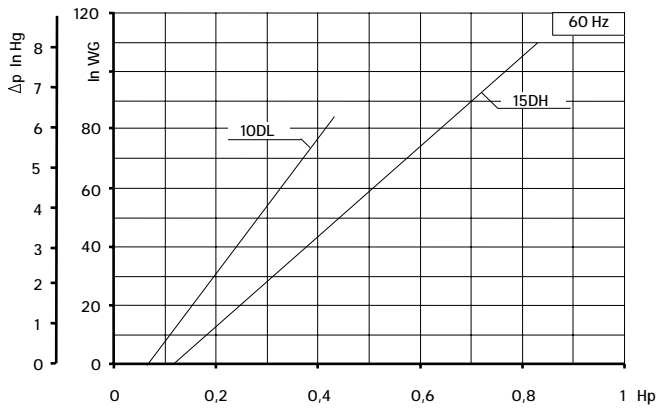
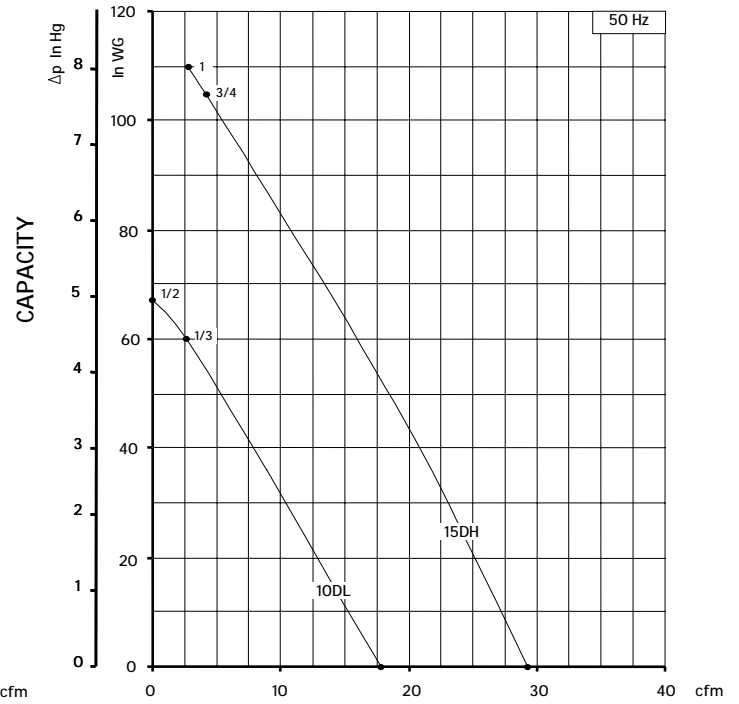
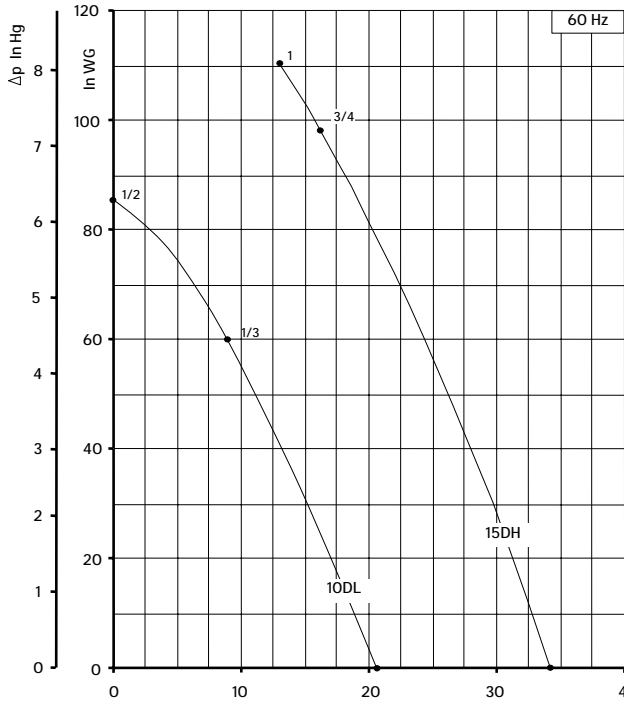

Curves refer to air at 68° F temperature, measured at inlet port and 29.92 In Hg atmospheric backpressure (abs).
Values for flow, power consumption and temperature rise: +/-10% tolerance.
Data subject to change without notice.

STANDARD FEATURES

- Low weight cast aluminum construction.
- Quiet operation with integral inlet and outlet muffling.
- Recognized TEFC - cURus motor.
- High efficiency / low noise impeller design.
- No lubrication / maintenance required.
- Allowed ambient: +5 °F to +104 °F.
- Mountable in any plane.

OPTIONS

- Remote drive models (belt or coupling).
- Special voltages.
- Surface treatment or plating.
- Gas tight sealing.
- Special designs available.

ACCESSORIES

- Inlet and/or inline filters.
- Additional inlet/outlet silencers.
- Safety valves.
- Flow converting devices.
- Optional connectors

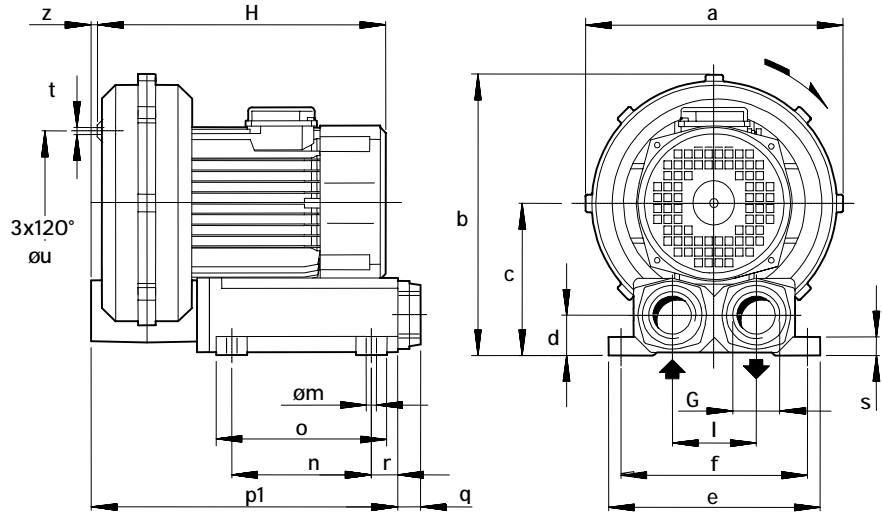

Dimensions in inches.

Dimension for reference only.

Model	a	b	c	d	e	f	G	I	m	n	o	p1	q	r	s	t	u	z
R20-MD	11.22	12.20	6.57	1.77	9.05	8.27	1" ¼ NPT	3.54	0.40	5.90	7.68	13.5	0.71	1.77	0.78	M6	5.91	-
30DH	12.60	13.66	7.36	2.09	10.63	9.64	1" ½ NPT	4.13	0.39	7.28	9.25	16.54	0.71	2.17	0.79	M6	7.09	0.67
40DH	13.78	14.57	7.68	2.09	10.63	9.65	1" ½ NPT	4.13	0.39	7.28	9.25	17.32	0.71	2.17	0.79	M8	8.86	-

Model	Maximum flow cfm		Installed power Hp		Maximum differential pressure Δp (In Hg)		Noise level Lp dB (A) (1)		Overall dimensions H Inches	Weight Lbs
	60 Hz 3500 rpm	50 Hz 2900 rpm	60 Hz 3500 rpm	50 Hz 2900 rpm	60 Hz 3500 rpm	50 Hz 2900 rpm	60 Hz 3500 rpm	50 Hz 2900 rpm		
R20-MD	41	34	1 ½	1 ½	8.8	8.8	68.0	65.0	13.86	47.30
30DH	70	61	2	2	10.3	8.9	69.7	67.7	15.36	58.30
40DH	98	85	3	3	11.1	10.3	74.7	71.7	16.93	75.00

(1) Noise measured at 1 m distance with inlet and outlet ports piped, in accordance to ISO 3744.

- For proper use, the blower should be equipped with inlet filter and safety valve; other accessories available on request.
- Ambient temperature from +5° to +104°F.
- Specifications subject to change without notice.

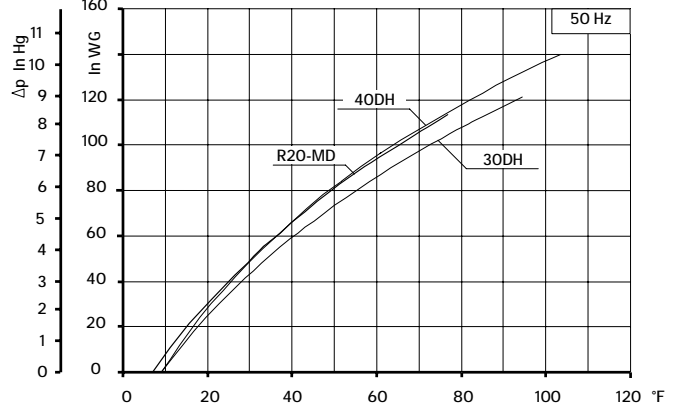
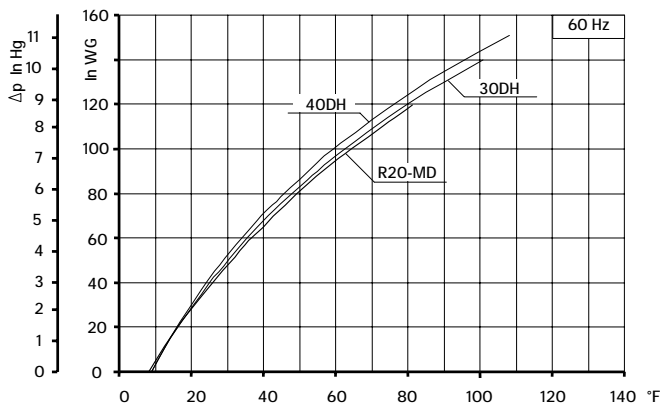
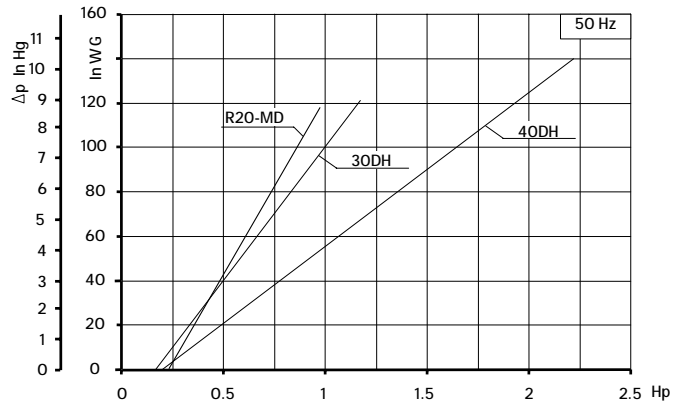
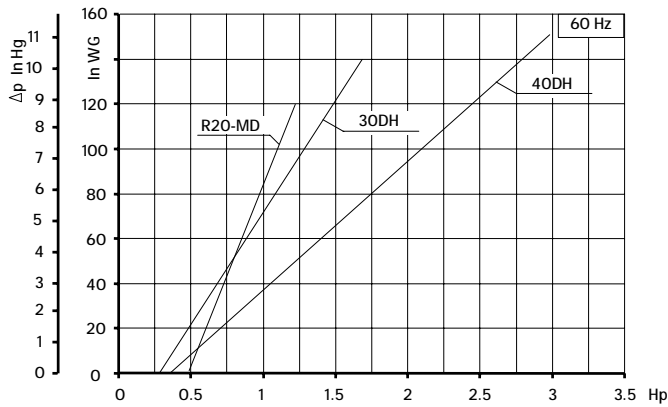
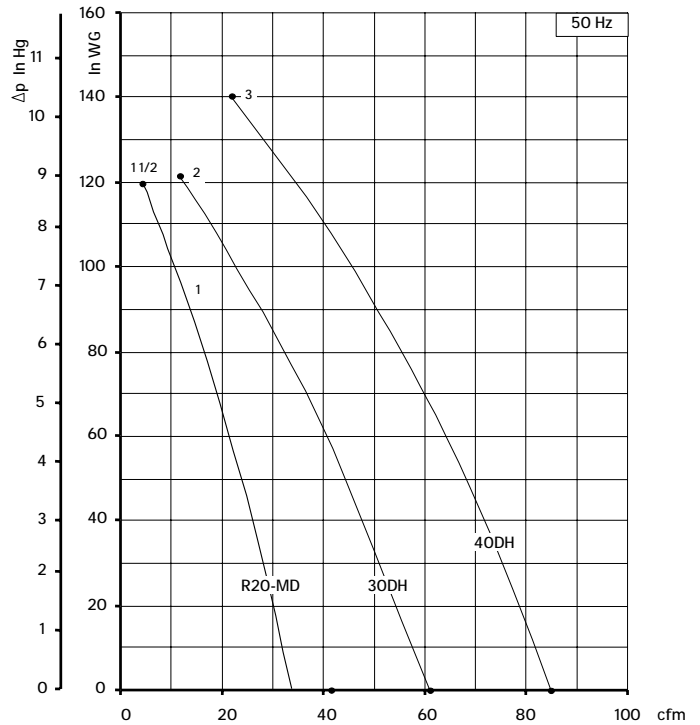
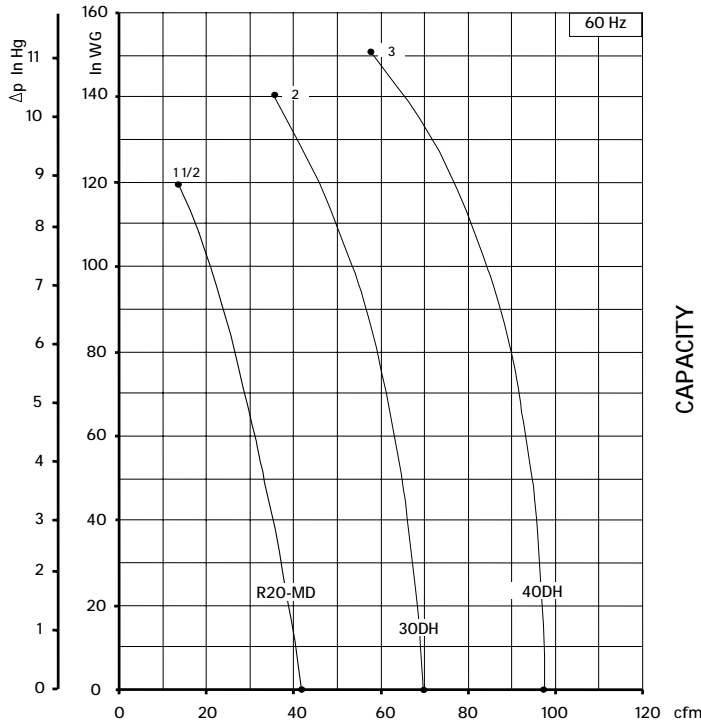

Curves refer to air at 68° F temperature, measured at inlet port and 29.92 In Hg atmospheric backpressure (abs).
 Values for flow, power consumption and temperature rise: +/-10% tolerance.
 Data subject to change without notice.

TECHNICAL CHARACTERISTICS

- Aluminium alloy construction
- Smooth operation
- High efficiency impeller
- Maintenance free
- Mountable in any position

OPTIONS

- Special voltages (IEC 38)
- Surface treatments

ACCESSORIES

- Inlet and/or inline filters
- Additional inlet/outlet silencers
- Safety valves
- Flow converting device
- Optional connectors

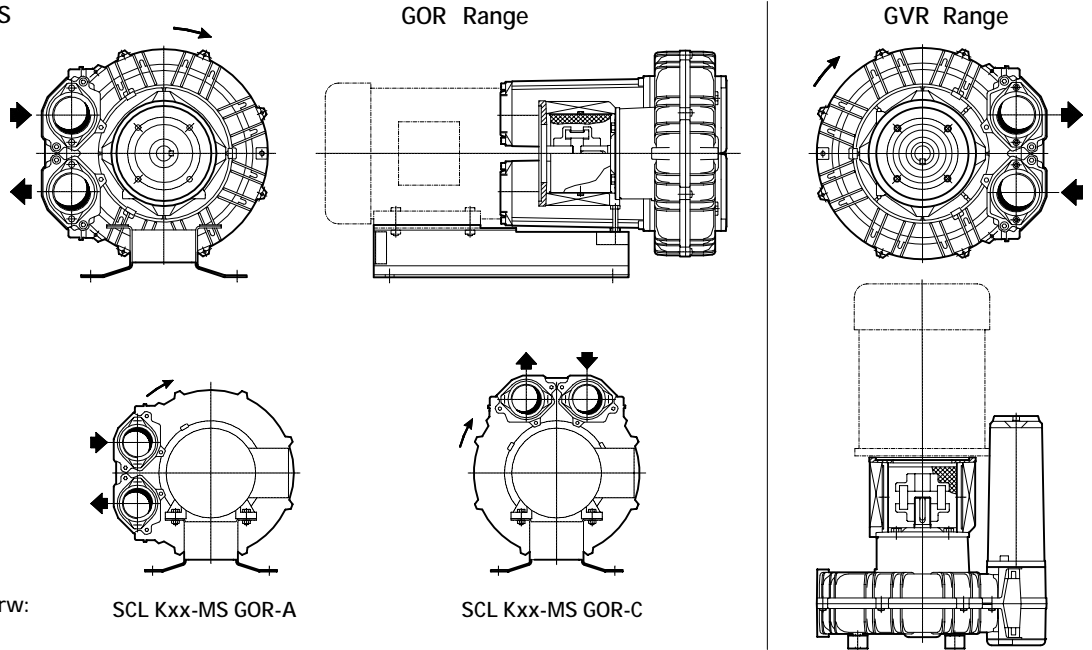

For dimensions, please refer to drw:

- GOR range: SI 1852
- GVR range: SI 1946

SCL Kxx-MS GOR-A

SCL Kxx-MS GOR-C

Model	Maximum flow cfm		Installed power Hp	Size	Maximum differential pressure Δp (in Hg)		Noise level Lp dB (A) (1)		Weight (2)		
	60 Hz 3500 rpm	50 Hz 2900 rpm			60 Hz 3500 rpm	50 Hz 2900 rpm	60 Hz 3500 rpm	50 Hz 2900 rpm	Lbs GOR	Lbs GVR	
K03-MS	52	43	3/4	NEMA 56C	4.7	3.7	61.0	59.0	22.00	17.60	
K04-MS	98	81	1 1/2	NEMA 56C	4.3	5.9	63.8	61.8	27.60	22.00	
			2	NEMA 56C	6.3		64.0				
			3	NEMA 56C	6.6		64.2				
K05-MS	156	129	2	NEMA 143-5TC	3.8	5.2	69.5	67.5	35.00	28.00	
			3	NEMA 143-5TC	6.6		69.8				
			5	NEMA 182-4TC	8.1		70.4				
K06-MS	216	179	3	NEMA 143-5TC	3.7	4.8	72.0	70.0	46.00	38.40	
			5	NEMA 182-4TC			6.3				72.6
			7 1/2	NEMA 182-4TC			9.6				72.9

(1) Noise measured at 1 m distance with inlet and outlet ports piped, in accordance to ISO 3744.

(2) Value is referred to weight of the machine without electric motor.

- For proper use, the blower should be equipped with inlet filter and safety valve; other accessories available on request.
- Ambient temperature from +5° to +104°F.
- Specifications subject to change without notice.

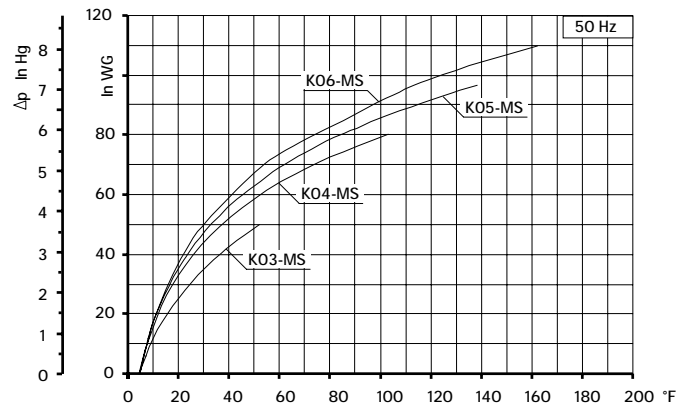
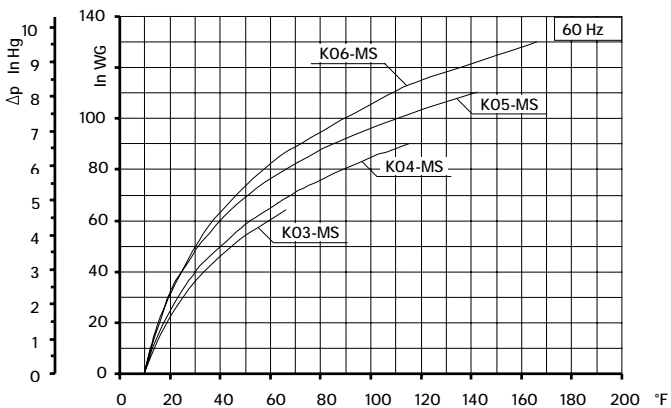
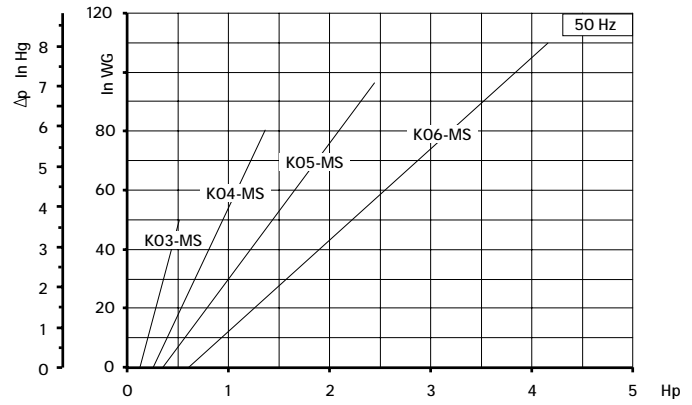
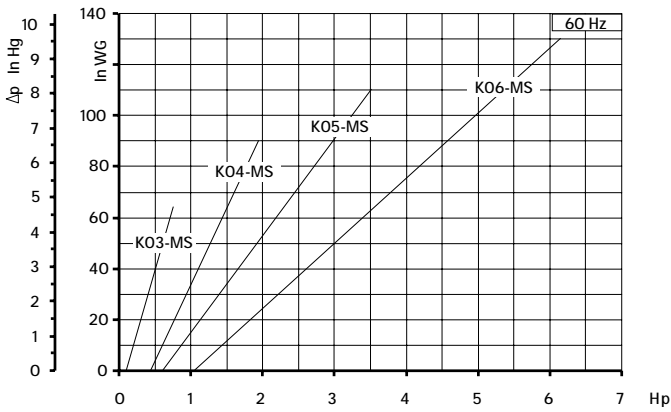
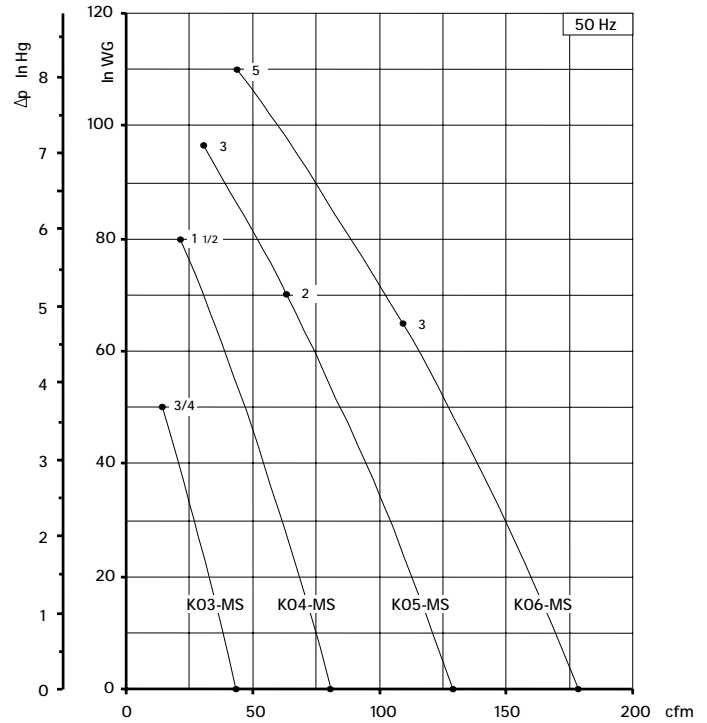
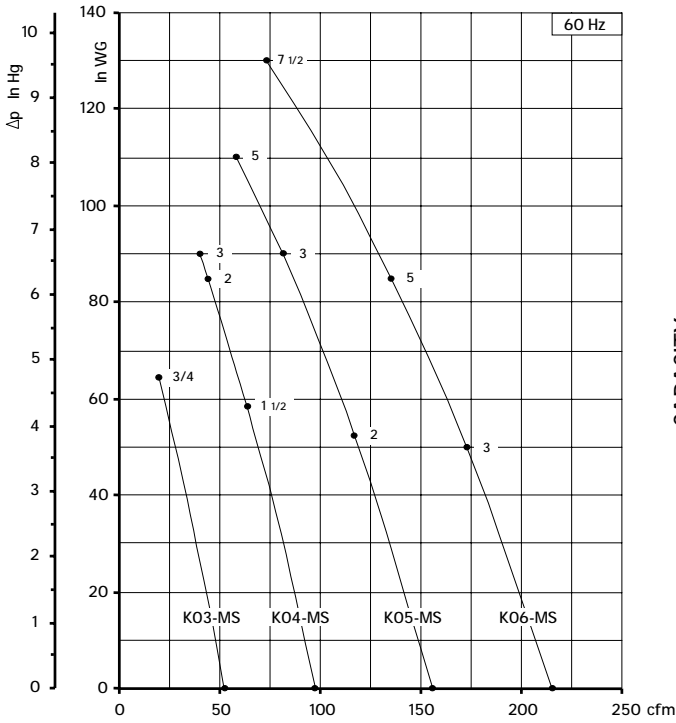

Curves refer to air at 68° F temperature, measured at inlet port and 29.92 In Hg atmospheric backpressure (abs).
 Values for flow, power consumption and temperature rise: +/-10% tolerance.
 Data subject to change without notice.

TECHNICAL**CHARACTERISTICS**

- Aluminium alloy construction
- Smooth operation
- High efficiency impeller
- Maintenance free
- Mountable in any position

OPTIONS

- Special voltages (IEC 38)
- Surface treatments

ACCESSORIES

- Inlet and/or inline filters
- Additional inlet/outlet silencers
- Safety valves
- Flow converting device
- Optional connectors

For dimensions, please refer to drw:

GOR range: SI 1873

GVR range: SI 1920

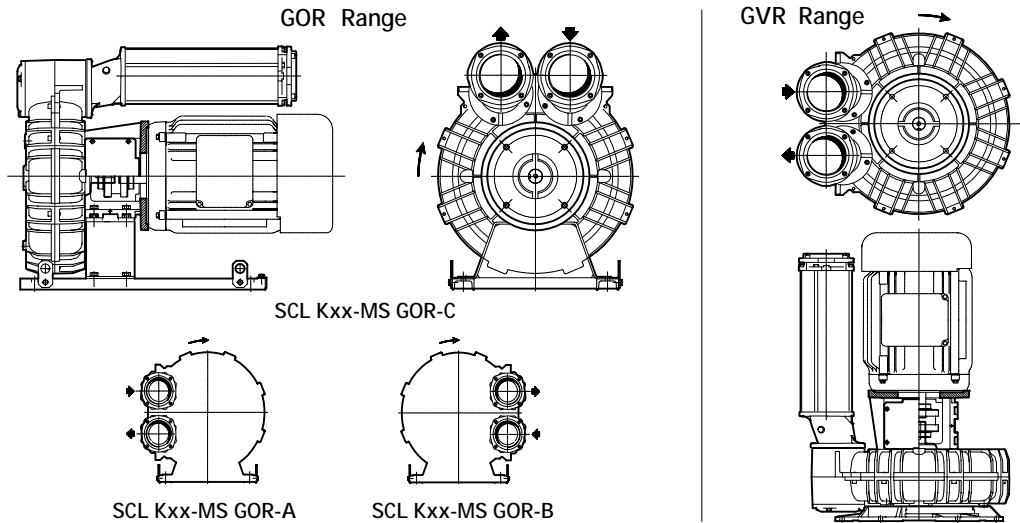

Model	Maximum flow cfm		Installed power Hp	Size	Maximum differential pressure Δp (in Hg)		Noise level Lp dB (A) (1)		Weight (2) Lbs
	60 Hz 3500 rpm	50 Hz 2900 rpm			60 Hz 3500 rpm	50 Hz 2900 rpm	60 Hz 3500 rpm	50 Hz 2900 rpm	
K07-MS	294	243	5	NEMA 182-4TC	5.1	6.3	78.0	76.0	110.50
			7 1/2	NEMA 182-4TC	9.6	8.8	78.3	76.3	110.50
				NEMA 213-5TC					110.50
K08-MS	381	316	5	NEMA 182-4TC	2.8	3.8	78.8	76.8	127.00
			7 1/2	NEMA 182-4TC	5.0	6.6	79.1	77.1	127.00
				NEMA 213-5TC					127.00
			10	NEMA 213-5TC	8.5	9.2	79.4	77.4	127.00
			15	NEMA 213-5TC	10.3		79.7		127.00
				NEMA 254-6TC			130.60		
K09-MS	471	390	7 1/2	NEMA 182-4TC	3.7	4.6	79.3	77.3	133.40
				NEMA 213-5TC					133.40
			10	NEMA 213-5TC	5.9	7.0	79.6	77.6	133.40
			15	NEMA 213-5TC	10.3	80.1	78.1	133.40	
				NEMA 254-6TC		80.4		137.00	
K10-MS	556	460	7 1/2	NEMA 182-4TC	2.2	3.7	79.4	77.4	147.30
				NEMA 213-5TC					147.30
			10	NEMA 213-5TC	4.4	5.9	79.7	77.7	147.30
			15	NEMA 213-5TC	8.1	9.6	80.2	78.2	147.30
				NEMA 254-6TC					151.00
20	NEMA 254-6TC	10.3	80.5	151.00					
K11-MS	650	539	10	NEMA 213-5TC	2.9	3.9	82.0	80.0	170.00
			15	NEMA 213-5TC	5.9	7.1	82.5	80.5	170.00
				NEMA 254-6TC					176.40
			20	NEMA 254-6TC	9.2	9.6	83.0	81.0	176.40
			25	NEMA 284-6TSC	10.3		83.8		170.00
K12-MS	726	602	15	NEMA 213-5TC	3.8	6.6	83.5	81.5	177.70
				NEMA 254-6TC					184.10
			20	NEMA 254-6TSC	6.3	9.6	84.3	82.3	184.10
			25	NEMA 284-6TSC	8.8		87.2		177.70
			30	NEMA 284-6TSC	10.3		87.6		177.70
							177.70		

(1) Noise measured at 1 m distance with inlet and outlet ports piped, in accordance to ISO 3744.

(2) Value is referred to weight of the machine without electric motor

- For proper use, the blower should be equipped with inlet filter and safety valve; other accessories available on request.
- Ambient temperature from +5° to +104°F.
- Specifications subject to change without notice.

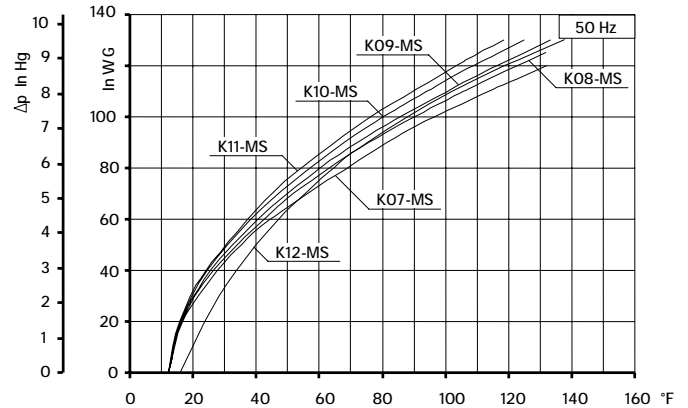
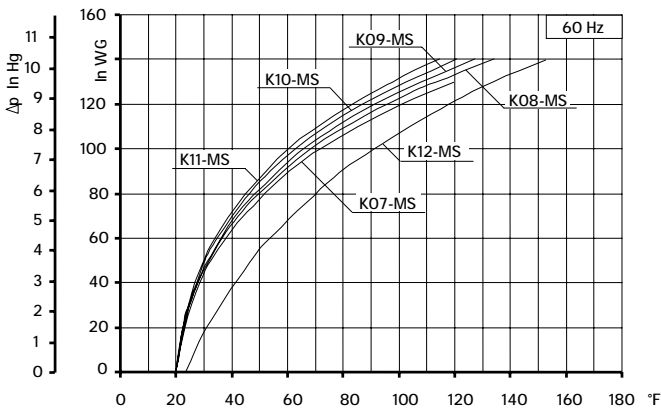
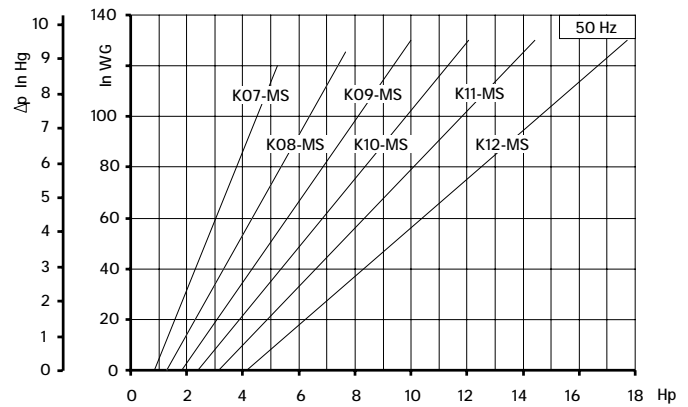
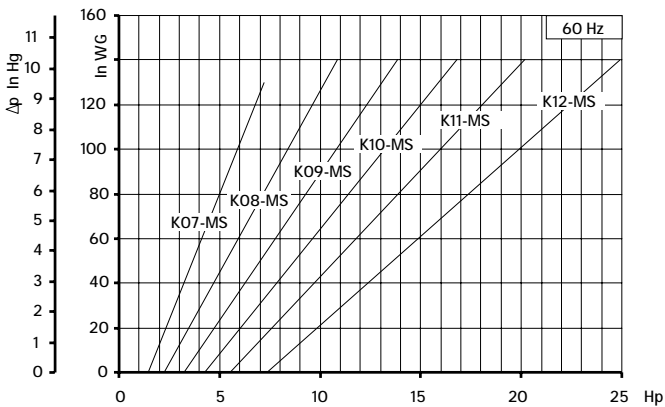
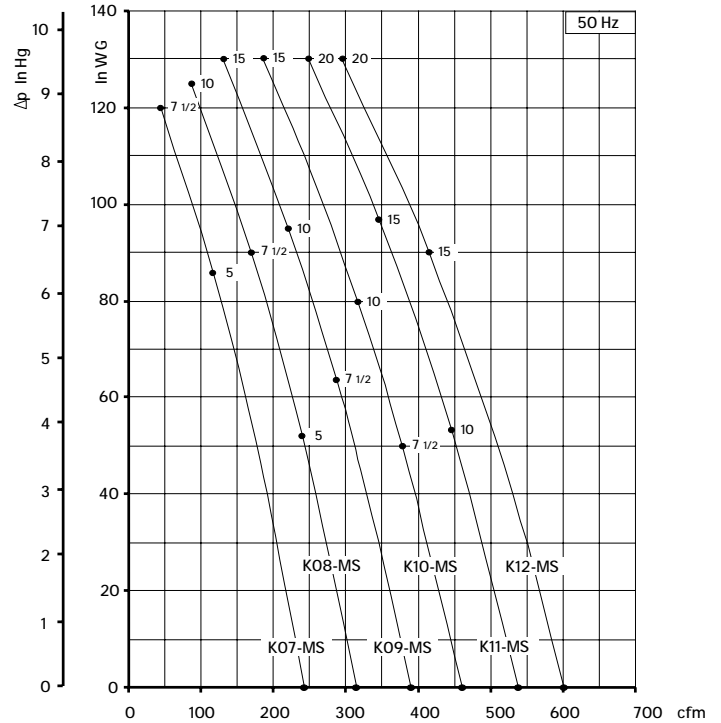
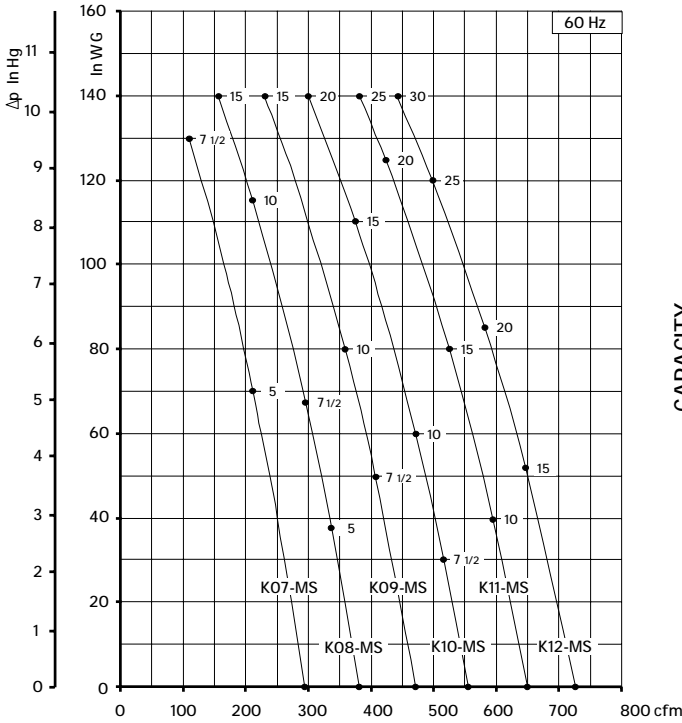

Curves refer to air at 68° F temperature, measured at inlet port and 29.92 In Hg atmospheric backpressure (abs).
 Values for flow, power consumption and temperature rise: +/-10% tolerance.
 Data subject to change without notice.

TECHNICAL CHARACTERISTICS

- Aluminium alloy construction
- Smooth operation
- High efficiency impeller
- Maintenance free
- Mountable in any plane
- G1/8" female thread on both suction and discharge silencer port flanges.

OPTIONS

- Special voltages (IEC 38)
- Surface treatments

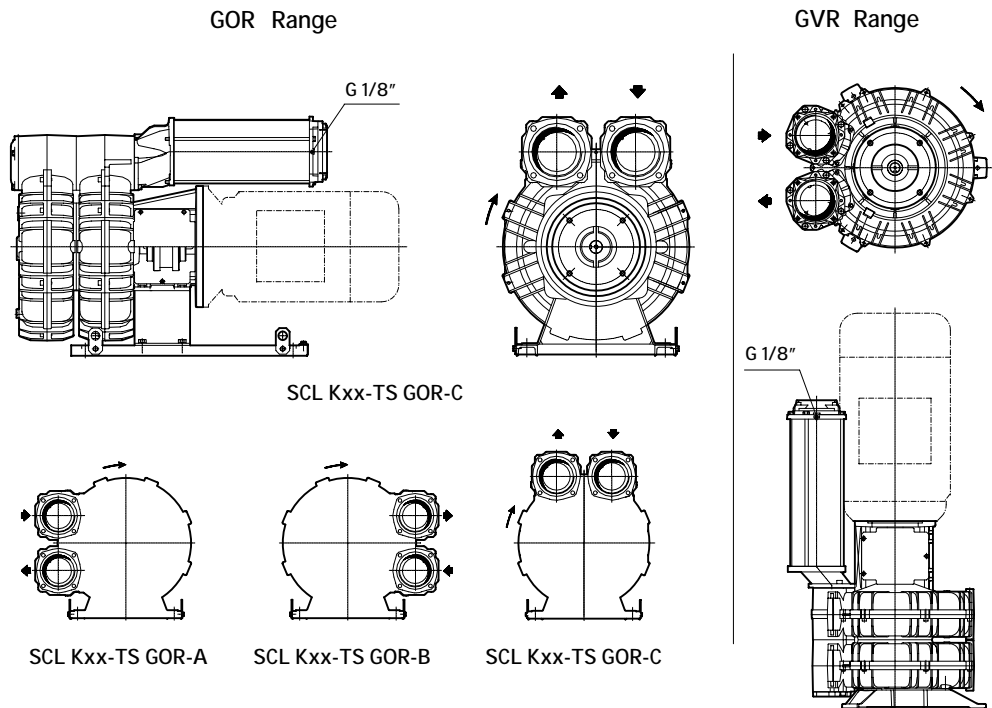

For dimensions, please refer to drw:

- GOR range: SI 21 23
- GVR range: SI 21 35

Model	Maximum flow m ³ /h		Installed power Hp	Size	Maximum differential pressure Δp (in Hg)		Noise level Lp dB (A) (1)		Weight (2)	
	60 Hz 3500 rpm	50 Hz 2900 rpm			60 Hz 3500 rpm	50 Hz 2900 rpm	60 Hz 3500 rpm	50 Hz 2900 rpm	Lbs	
									GOR	GVR
K05-TS	290	241	5.0	NEMA 182-4TC	4.4	6.3	75.1	73.1	72.75	68.35
			7.5		7.4	6.7	77.1	75.1		
K06-TS	400	331	7.5	NEMA 213-5TC	4.1	5.7	77.1	75.1	112.45	108.00
			10		5.9	7.4	77.4	75.4		
			15		7.8		78.0	76.0		

(1) Noise measured at 1 m distance with inlet and outlet ports piped, in accordance to ISO 3744.

(2) Value is referred to weight of the machine without electric motor.

- For proper use, the blower should be equipped with inlet filter and safety valve; other accessories available on request.
- Ambient temperature from +5° to +104°F.
- Specifications subject to change without notice.

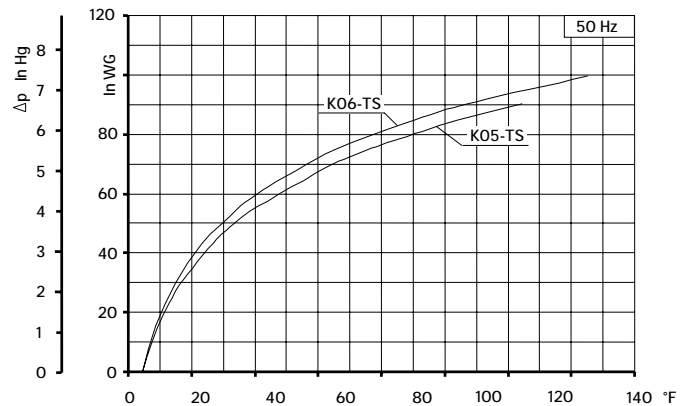
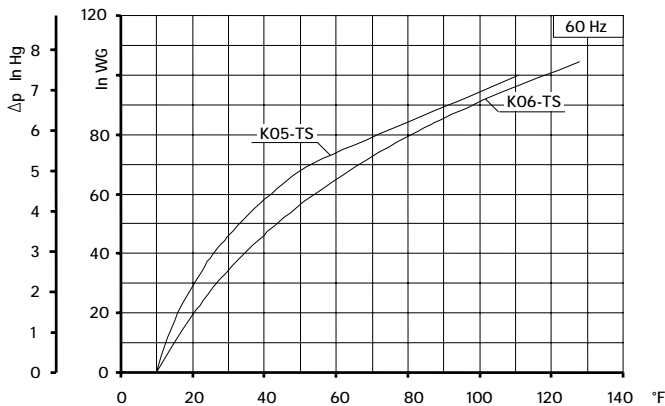
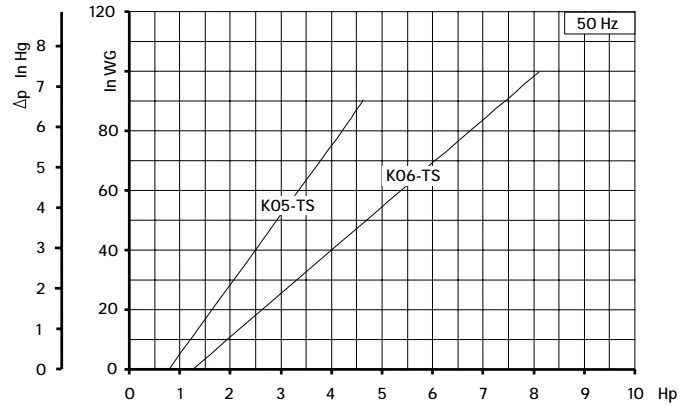
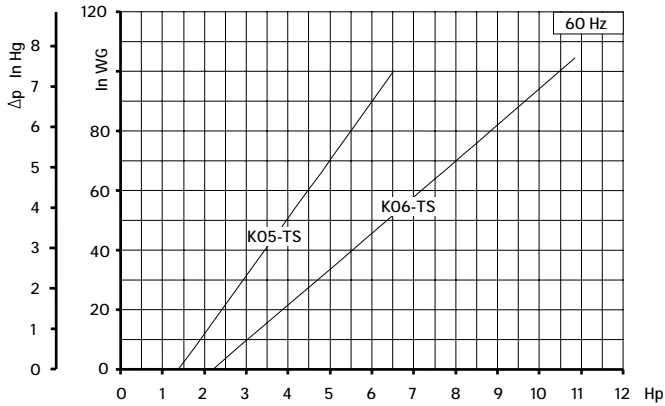
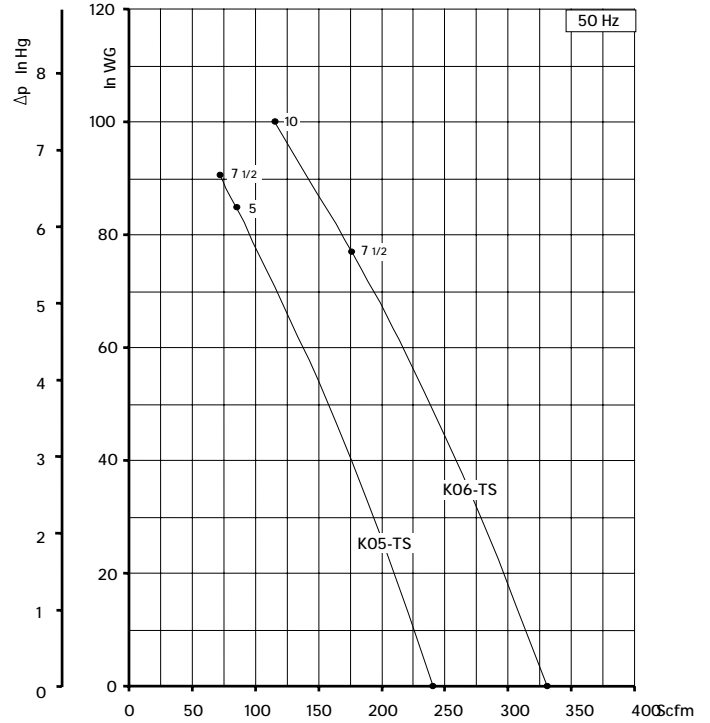
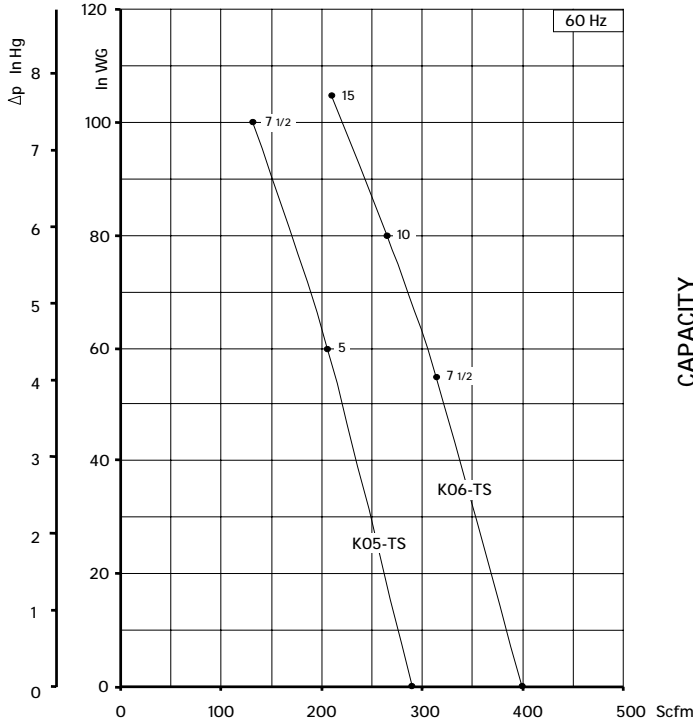

Curves refer to air at 20°C temperature, measured at inlet port and 1013 mbar (abs) atmospheric backpressure.
 Values for flow, power consumption and temperature rise: +/-10% tolerance.
 Data subject to change without notice.

TECHNICAL CHARACTERISTICS

- Aluminium alloy construction
- Smooth operation
- High efficiency impeller
- Maintenance free
- Mountable in any position
- G1/8" female thread on both suction and discharge silencer port flanges

OPTIONS

- Special voltages (IEC 38)
- Surface treatments

ACCESSORIES

- Inlet and/or inline filters
- Additional inlet/outlet silencers
- Safety valves
- Flow converting device
- Optional connectors

For dimensions, please refer to drw:

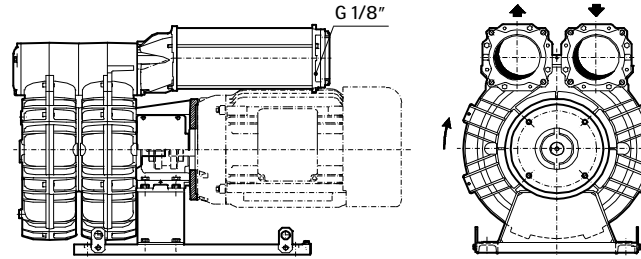
GOR range: SI 1879
GVR range: SI 1880
GOR RANGE

SCL Kxx-TS GOR-C

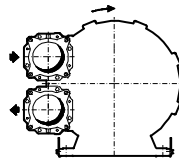
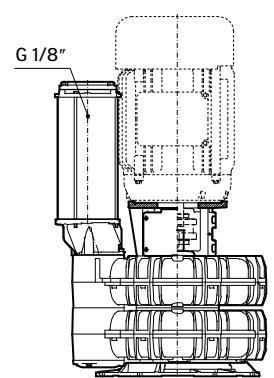
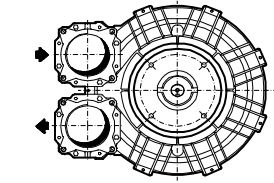
GVR RANGE

SCL Kxx-TS GOR-A

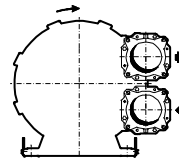

SCL Kxx-TS GOR-B

Model	Maximum flow cfm		Installed power Hp	Size	Maximum differential pressure Δp (In Hg)		Noise level Lp dB (A) (1)		Weight (2) Lbs
	60 Hz 3500 rpm	50 Hz 2900 rpm			60 Hz 3500 rpm	50 Hz 2900 rpm	60 Hz 3500 rpm	50 Hz 2900 rpm	
K07-TS	588	487	7 1/2	NEMA 182-4TC	2.6	4.4	84.5	82.5	160.90
				NEMA 213-5TC	2.6	4.4	84.5	82.5	160.90
			10	NEMA 213-5TC	4.4	6.6	84.8	82.8	160.90
			15	NEMA 213-5TC	8.1	8.1	85.4	83.4	160.90
				NEMA 254-6TC (3)	8.1	8.1	85.4	83.4	167.60
20	NEMA 254-6TC (3)	8.8	8.1	85.9	83.4	167.60			
K08-TS	715	592	10	NEMA 213-5TC	2.7	4.7	81.2	79.2	172.00
			15	NEMA 213-5TC	5.5	7.7	82.9	80.9	172.00
				NEMA 254-6TC (3)	5.5	7.7	82.9	80.9	180.80
			20	NEMA 254-6TC (3)	7.4	8.8	84.8	80.8	180.80
25	NEMA 284-6TSC (3)	9.6	8.8	87.0	80.8	174.20			
K09-TS	941	780	15	NEMA 213-5TC	3.8	5.5	82.2	80.2	202.80
				NEMA 254-6TC (3)	3.8	5.5	82.2	80.2	208.30
			20	NEMA 254-6TC (3)	5.9	7.9	84.1	82.1	208.30
			25	NEMA 284-6TSC (3)	8.1	8.8	86.1	84.1	205.00
			30	NEMA 284-6TSC (3)	8.8	8.8	88.1	84.1	205.00
40	NEMA 324-6TSC (3)	9.6	8.8	90.1	84.1	220.50			
K10-TS	1093	906	15	NEMA 213-5TC	3.0	4.7	89.1	87.1	209.40
				NEMA 254-6TC (3)	3.0	4.7	89.1	87.1	216.10
			20	NEMA 254-6TC (3)	4.8	6.6	89.4	87.4	216.10
			25	NEMA 284-6TSC (3)	5.9	8.1	89.7	87.7	211.60
			30	NEMA 284-6TSC (3)	7.4	9.6	90.0	88.0	211.60
40	NEMA 324-6TSC (3)	10.3	9.6	90.3	88.0	227.10			
K11-TS	1254	1039	25	NEMA 284-6TSC	3.7	6.5	90.7	88.7	251.30
			30	NEMA 284-6TSC	5.1	8.1	91.3	89.3	251.30
			40	NEMA 324-6TSC (3)	7.4	9.6	91.9	89.9	269.00
			50	NEMA 324-6TSC (3)	10.3	9.6	92.5	89.9	269.00
K12-TS	1410	1168	30	NEMA 284-6TSC	3.3	5.9	91.9	89.9	249.10
			40	NEMA 324-6TSC (3)	5.2	8.8	92.5	90.5	266.80
			50	NEMA 324-6TSC (3)	8.1	-	93.1	-	266.80

(1) Noise measured at 1 m distance with inlet and outlet ports piped, in accordance to ISO 3744.

(2) Value is referred to weight of the machine without electric motor

(3) Not applicable on SCL Kxx - GVR

- For proper use, the blower should be equipped with inlet filter and safety valve; other accessories available on request.

- Specifications subject to change without notice.

- Ambient temperature from +5° to +104°F.

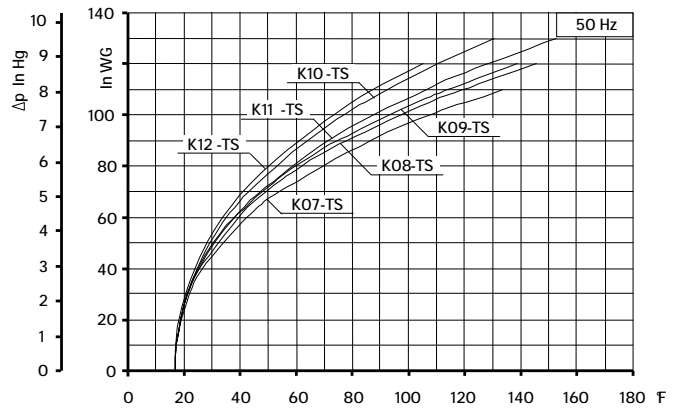
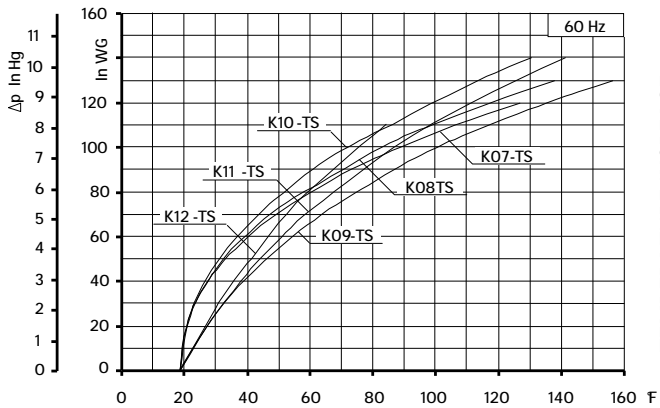
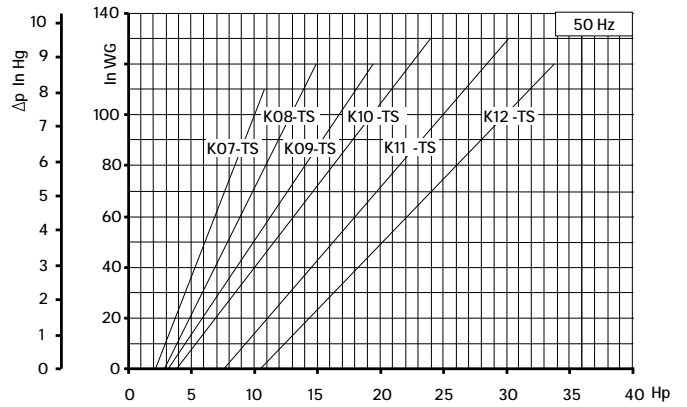
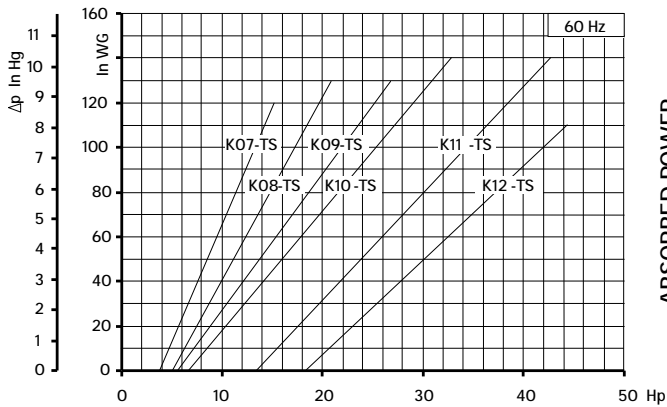
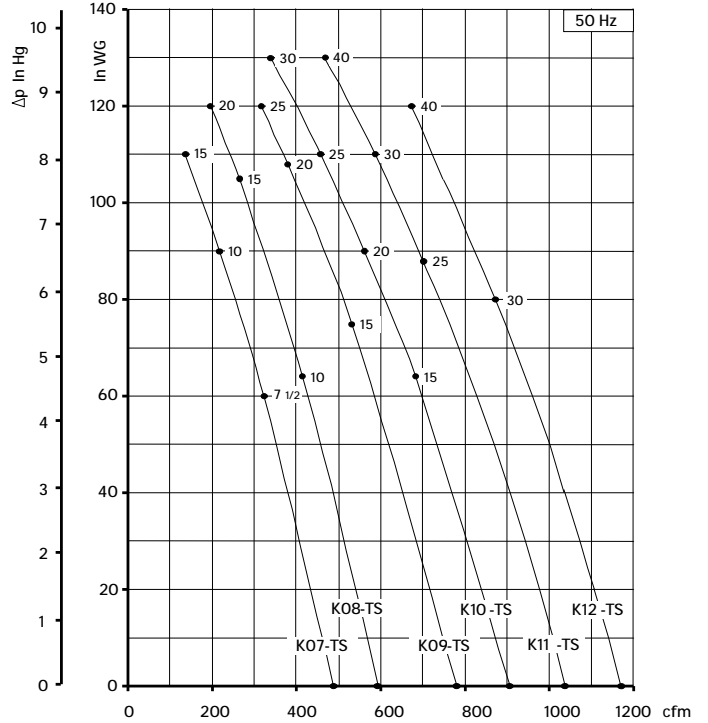
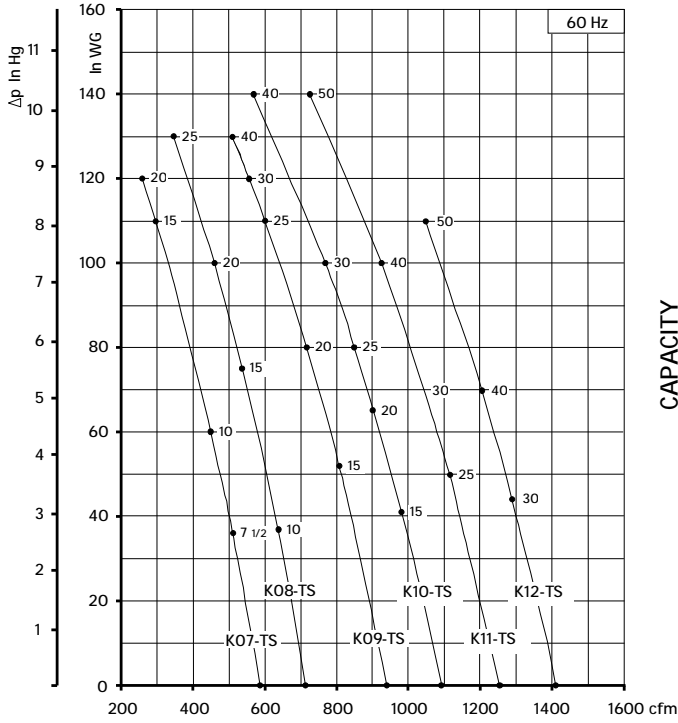

Curves refer to air at 68°F temperature, measured at inlet port and 29.92 In Hg atmospheric backpressure (abs).
 Values for flow, power consumption and temperature rise: +/-10% tolerance.
 Data subject to change without notice.

TECHNICAL CHARACTERISTICS

- Aluminium alloy construction
- Smooth operation
- High efficiency impeller
- Maintenance free
- Mountable in any position

OPTIONS

- Special voltages (IEC 38)
- Surface treatments

ACCESSORIES

- Inlet and/or inline filters
- Additional inlet/outlet silencers
- Safety valves
- Flow converting device
- Optional connectors

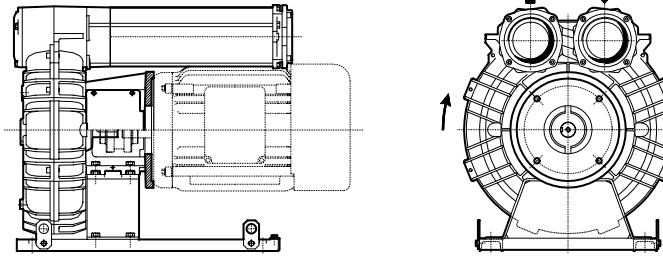
GOR Range

SCL Kxx-MD GOR-C

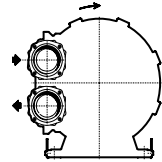

SCL Kxx-MD GOR-A

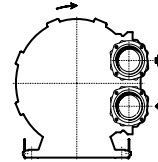

SCL Kxx-MD GOR-B

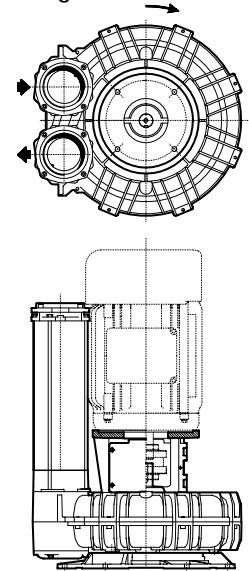
GVR Range

For dimensions, please refer to drw:

GOR range: SI 1918

GVR range: SI 1919

Model	Maximum flow cfm		Installed power Hp	Size	Maximum differential pressure Δp (In Hg)		Noise level Lp dB (A) ⁽¹⁾		Weight ⁽²⁾ Lbs
	60 Hz 3500 rpm	50 Hz 2900 rpm			60 Hz 3500 rpm	50 Hz 2900 rpm	60 Hz 3500 rpm	50 Hz 2900 rpm	
K07R-MD	129	107	3	NEMA 56C	5.0	6.4	72.5	70.5	112.00
				NEMA 143-5TC					112.00
			5	NEMA 182-4TC	10.7	12.5	73.5	71.5	113.80
			7 1/2	NEMA 182-4TC NEMA 213-5TC	13.2	13.2	74.0	72.0	113.80 113.80
K08R-MD	168	139	5	NEMA 182-4TC	5.9	8.1	75.7	73.7	130.30
			7 1/2	NEMA 182-4TC NEMA 213-5TC	11.9	13.2	76.1	74.1	130.30 130.30
			10	NEMA 213-5TC	13.2	-	76.5	-	130.30
K09-MD	221	183	5	NEMA 182-4TC	3.7	5.7	76.4	74.4	138.50
			7 1/2	NEMA 182-4TC NEMA 213-5TC	8.8	10.5	77.5	75.5	138.50 138.50
			10	NEMA 213-5TC	13.6	13.2	79.0	77.0	138.50
K10-MD	275	228	7 1/2	NEMA 182-4TC NEMA 213-5TC	6.3	8.1	80.4	78.4	125.40 152.40
			10	NEMA 213-5TC	10.3	12.1	80.7	78.7	152.40
			15	NEMA 213-5TC	14.7	14.0	81.3	79.3	152.40
K11-MD	306	254	10	NEMA 213-5TC	7.4	9.2	80.7	78.7	175.70
			15	NEMA 213-5TC NEMA 254-6TC	14.0	14.0	81.3	79.3	175.70 182.10
K12-MD	336	278	15	NEMA 213-5TC NEMA 254-6TC	7.4	13.2	82.2	80.2	183.40 189.80
			20	NEMA 254-6TC	13.2	-	82.5	-	189.80

(1) Noise measured at 1 m distance with inlet and outlet ports piped, in accordance to ISO 3744.

(2) Value is referred to weight of the machine without electric motor

- For proper use, the blower should be equipped with inlet filter and safety valve; other accessories available on request.
- Ambient temperature from +5° to +104°F.
- Specifications subject to change without notice.

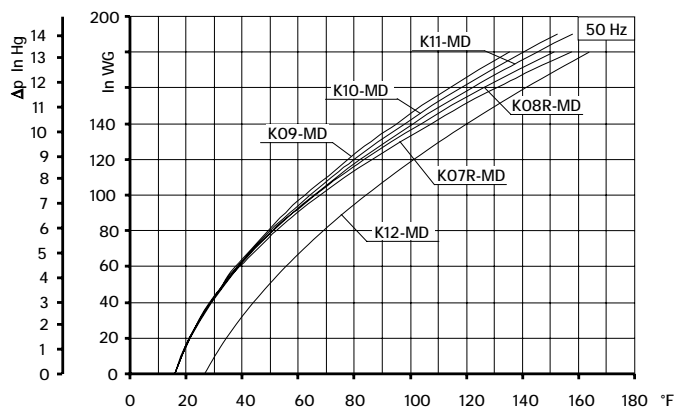
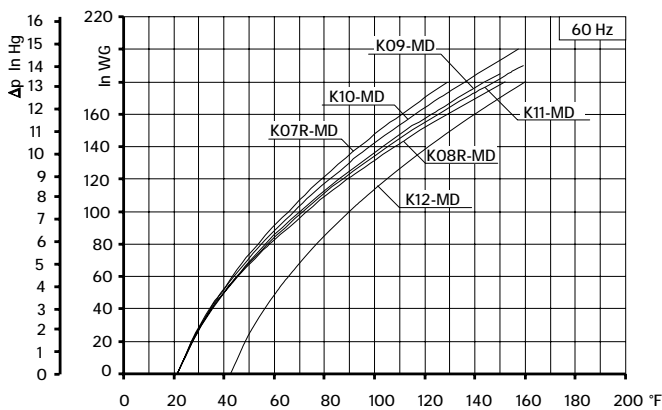
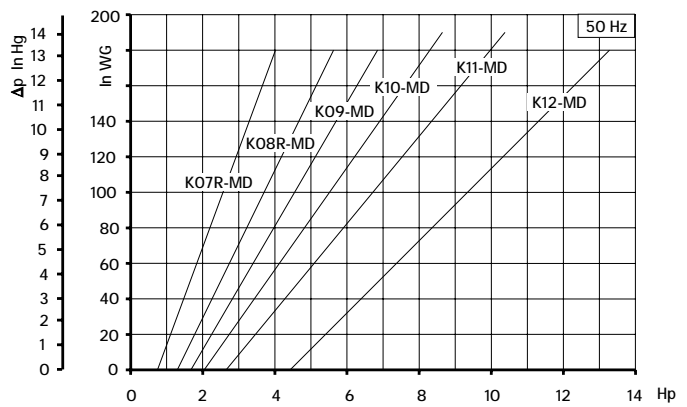
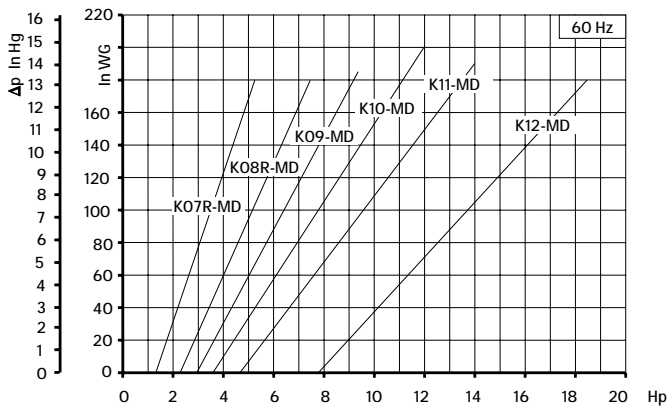
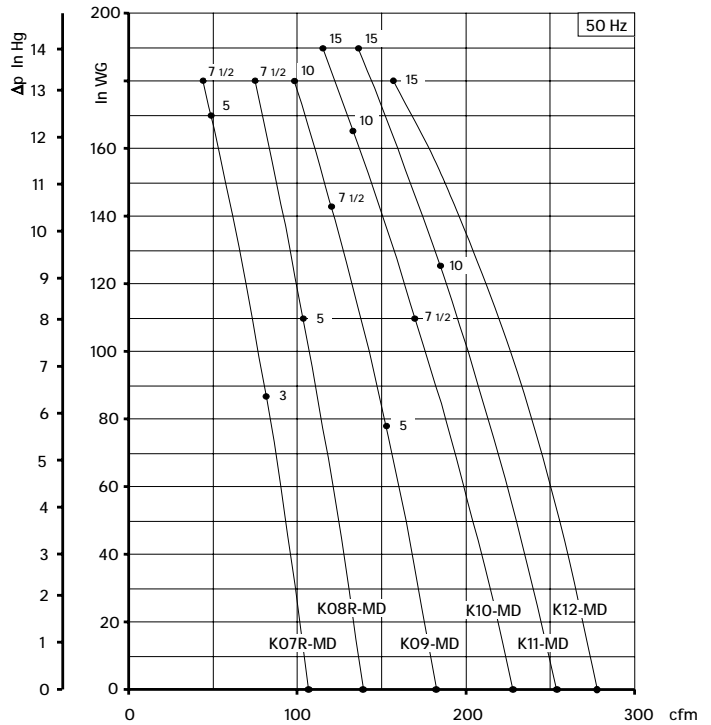
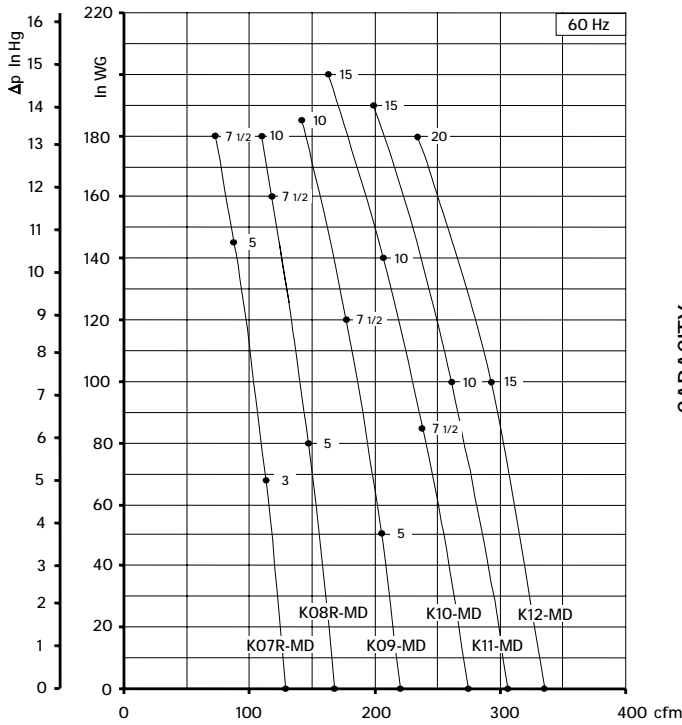

Curves refer to air at 68° F temperature, measured at inlet port and 29.92 In Hg atmospheric backpressure (abs).
 Values for flow, power consumption and temperature rise: +/-10% tolerance.
 Data subject to change without notice.

TECHNICAL CHARACTERISTICS

- Aluminium alloy construction
- Smooth operation
- High efficiency impeller
- Maintenance free
- Mountable in any position
- G1/8" female thread on both suction and discharge silencer port flanges

OPTIONS

- Special voltages (IEC 38)
- Surface treatments

ACCESSORIES

- Inlet and/or inline filters
- Additional inlet/outlet silencers
- Safety valves
- Flow converting device
- Optional connectors

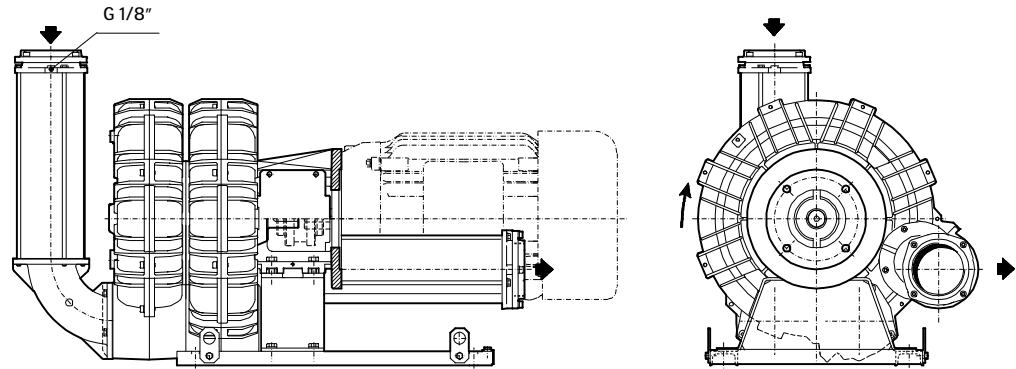
 For dimensions, please refer to drw: **SI1971**

Model	Maximum flow cfm		Installed power Hp	Size	Maximum differential pressure Δp (In Hg)		Noise level Lp dB (A) ⁽¹⁾		Weight ⁽²⁾ Lbs
	60 Hz 3500 rpm	50 Hz 2900 rpm			60 Hz 3500 rpm	50 Hz 2900 rpm	60 Hz 3500 rpm	50 Hz 2900 rpm	
K07-TD	296	245	7 1/2	NEMA 182-4TC	6.6	9.6	78.6	76.6	156.50
				NEMA 213-5TC					
			10	NEMA 213-5TC	9.9	12.5	78.9	76.9	
			15	NEMA 213-5TC	13.2				
			NEMA 254-6TC					160.90	
K08-TD	368	305	10	NEMA 213-5TC	7.0	10.3	79.3	77.3	169.80
			15	NEMA 213-5TC	12.5	12.5	79.9	77.9	169.80
				NEMA 254-6TC					178.60
K09-TD	467	387	15	NEMA 213-5TC	7.7	11.4	82.2	80.2	196.20
				NEMA 254-6TC					201.70
			20	NEMA 254-6TC	11.7	12.5	82.5	80.5	201.70
			25	NEMA 284-6TSC	13.2				198.40
K10-TD	571	473	15	NEMA 213-5TC	6.3	9.6	85.9	83.9	202.80
				NEMA 254-6TC					209.50
			20	NEMA 254-6TC	9.6	13.2	86.2	84.2	209.50
			25	NEMA 284-6TSC	13.2				205.00
K11-TD	642	532	20	NEMA 254-6TC	6.6	10.3	86.7	84.7	246.80
			25	NEMA 284-6TSC	9.6	13.2	87.2	85.2	244.70
			30	NEMA 284-6TSC	11.0				87.7
			40	NEMA 324-6TSC	12.5	88.1	264.50		
K12-TD	716	593	25	NEMA 284-6TSC	6.3	10.3	87.5	85.5	242.5
			30	NEMA 284-6TSC	8.8	13.2	88.0	86.0	242.5
			40	NEMA 324-6TSC	12.5	-	88.4	-	262.3

(1) Noise measured at 1 m distance with inlet and outlet ports piped, in accordance to ISO 3744.

(2) Value is referred to weight of the machine without electric motor

- For proper use, the blower should be equipped with inlet filter and safety valve; other accessories available on request.
- Ambient temperature from +5° to +104°F.
- Specifications subject to change without notice.

SCL K07 / K08 / K09 / K10 / K11 / K12
TD SERIES - GOR RANGE
SN 2180-4 2/2

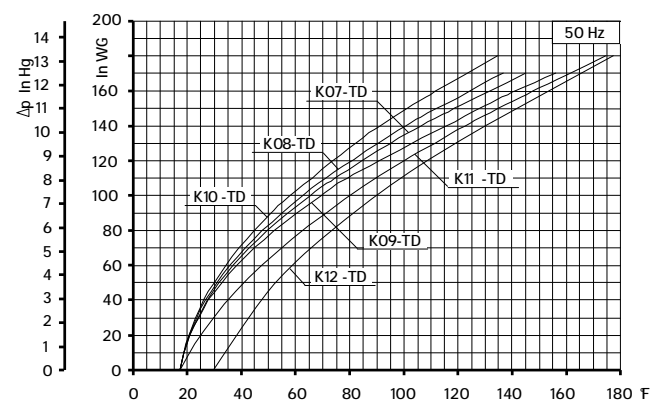
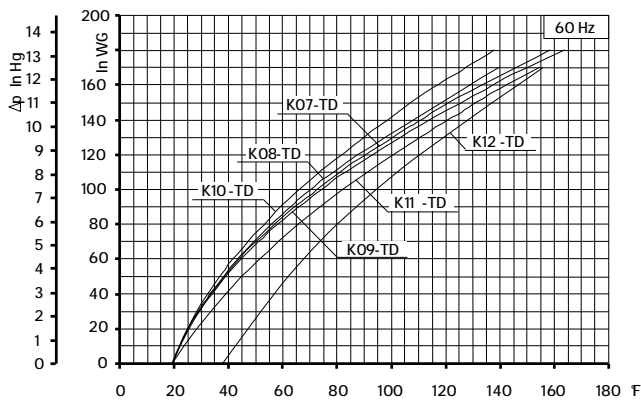
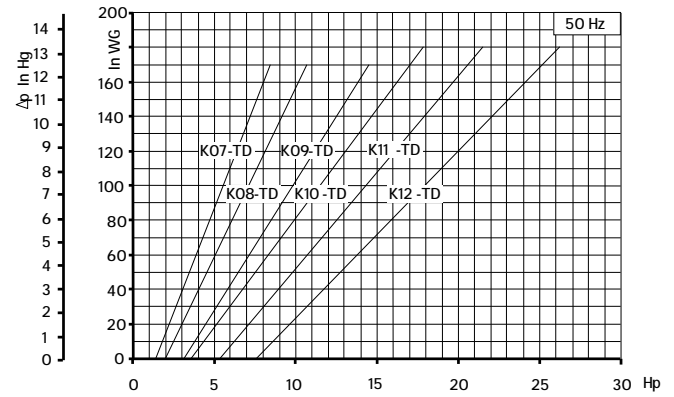
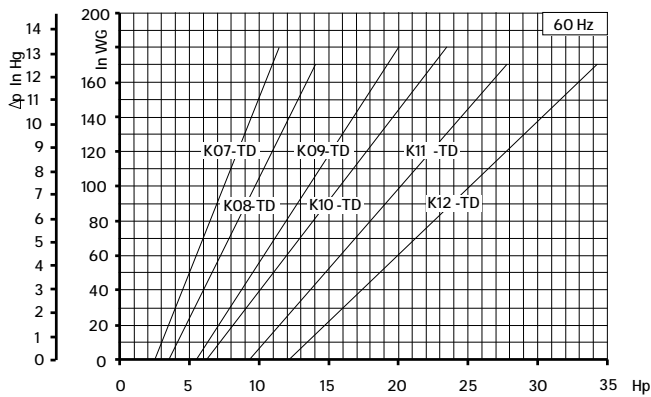
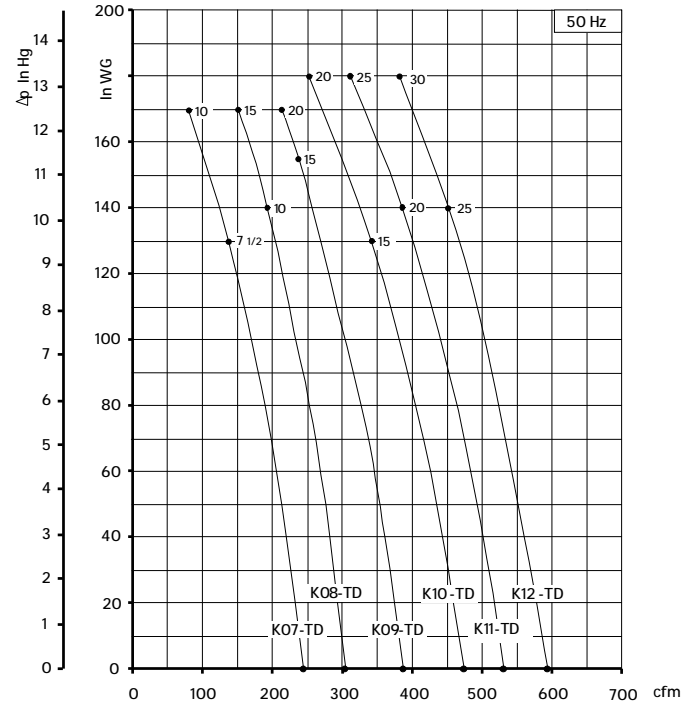
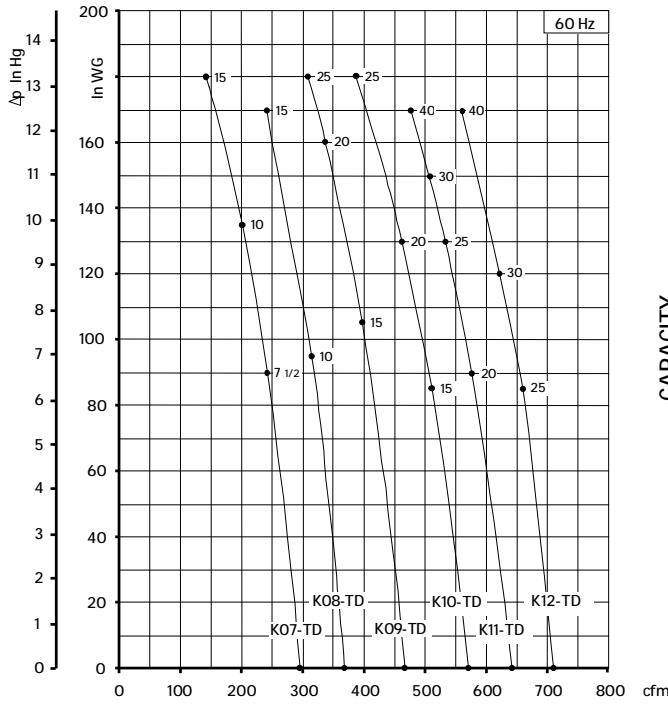

Curves refer to air at 68°F temperature, measured at inlet port and 29.92 In Hg atmospheric backpressure (abs).
Values for flow, power consumption and temperature rise: +/-10% tolerance.
Data subject to change without notice.

**TECHNICAL
CHARACTERISTICS**

- Aluminium alloy construction
- Smooth operation
- High efficiency impeller
- Maintenance free
- G1/8" female thread on both suction and discharge silencer port flanges

OPTIONS

- Special voltages (IEC 38)
- Surface treatments

ACCESSORIES

- Inlet and/or inline filters
- Additional inlet/outlet silencers
- Optional connectors

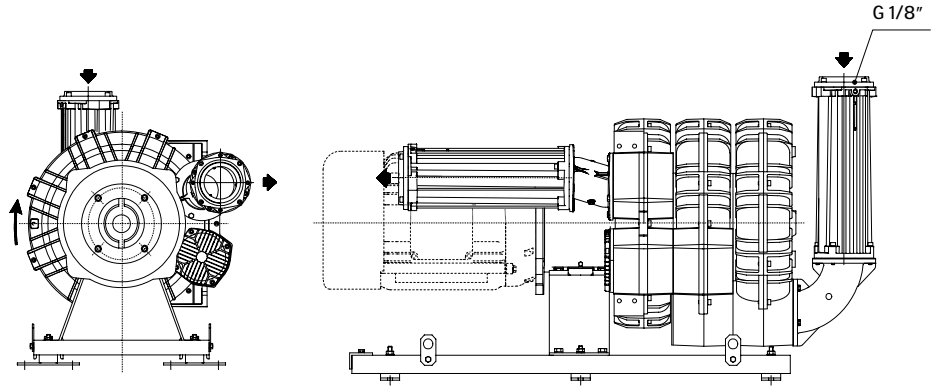

For dimensions, please refer to drw:
SI 21 80

Model	Maximum flow cfm		Installed power Hp	Size	Maximum differential pressure Δp (In Hg)		Noise level Lp dB (A) (1)		Weight (2) Lbs
	60 Hz 3500 rpm	50 Hz 2900 rpm			60 Hz 3500 rpm	50 Hz 2900 rpm	60 Hz 3500 rpm	50 Hz 2900 rpm	
	K09-TT	423			351	25 30	NEMA 284-6TSC	12.5 15.5	
K10-TT	526	436	25	NEMA 284-6TSC	-	14.7	-	85.5	365
			30	NEMA 284-6TSC	13.2	16.2	87.8	85.8	
			40	NEMA 324-6TSC	16.2	-	88.1	-	
K11-TT	597	495	30	NEMA 284-6TSC	-	14.7	-	85.8	430
			40	NEMA 324-6TSC	17.0	17.0	88.1	86.1	434

(1) Noise measured at 1 m distance with inlet and outlet ports piped, in accordance to ISO 3744.

(2) Value is referred to weight of the machine without electric motor

- For proper use, the blower should be equipped with inlet filter and safety valve; other accessories available on request.
- Ambient temperature from +5° to +104°F.
- Specifications subject to change without notice.

SCL K09 / K10 / K11
TT SERIES - GOR RANGE

SN 2784-4 2/2

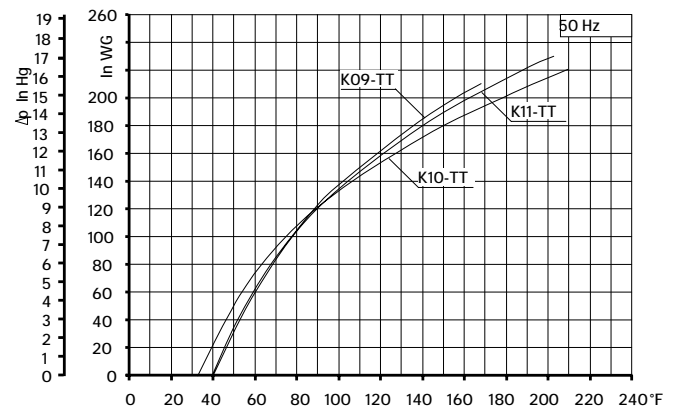
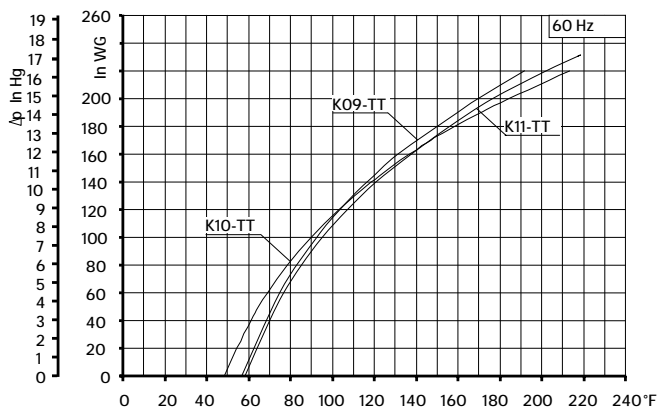
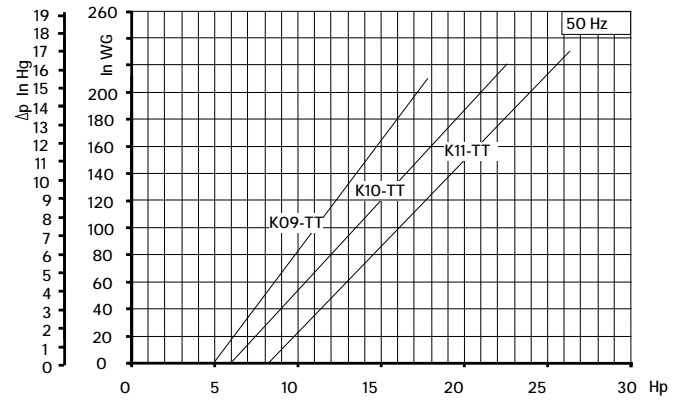
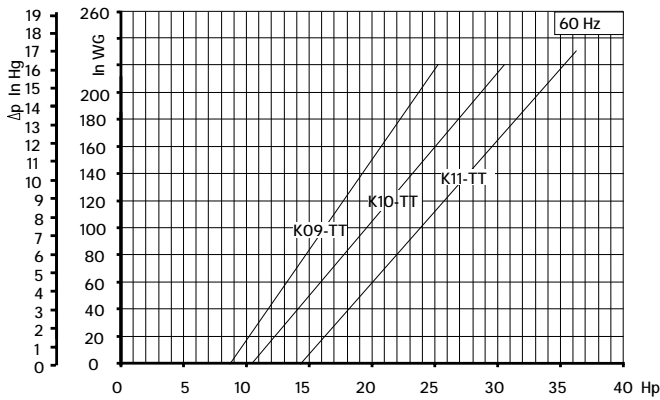
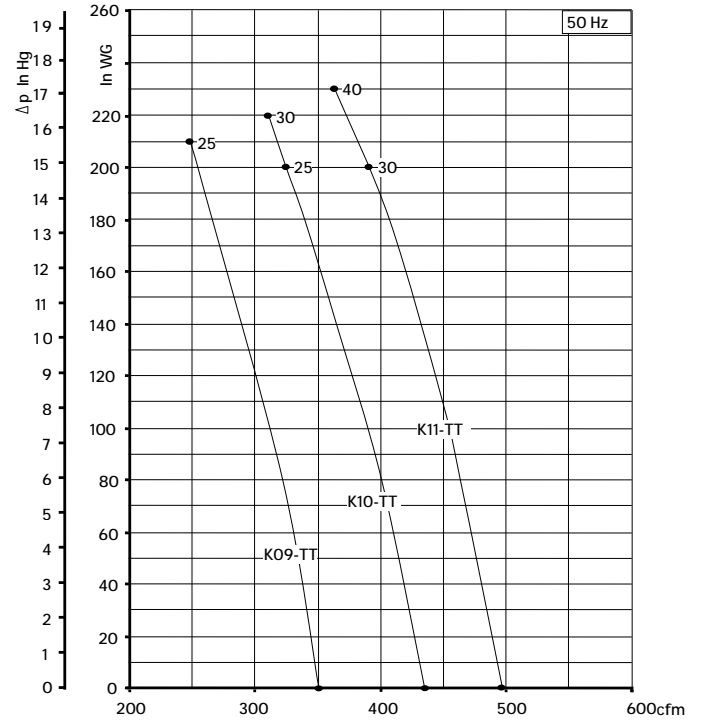
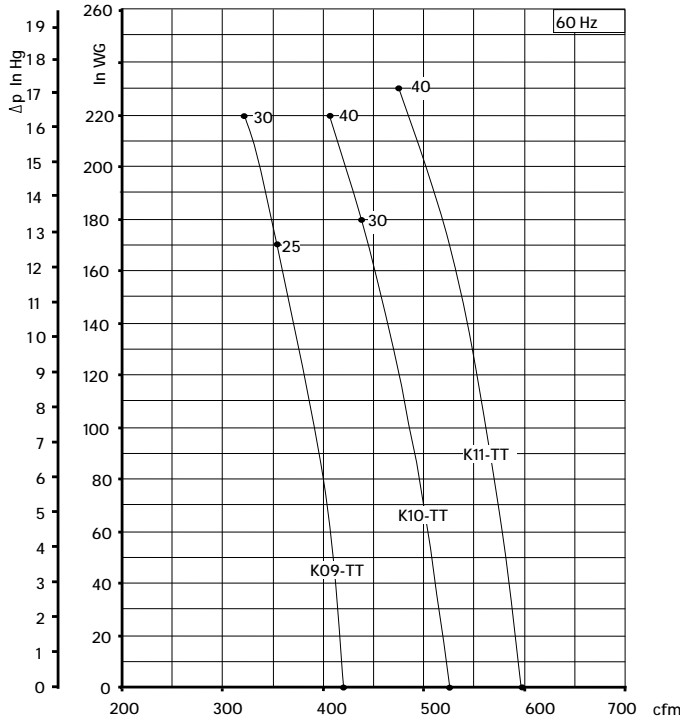

- Curves refer to air at 68° F temperature, measured at inlet port and 29.92 In Hg atmospheric backpressure (abs).
- Values for flow, power consumption and temperature rise: +/-10% tolerance.
- Data subject to change without notice.

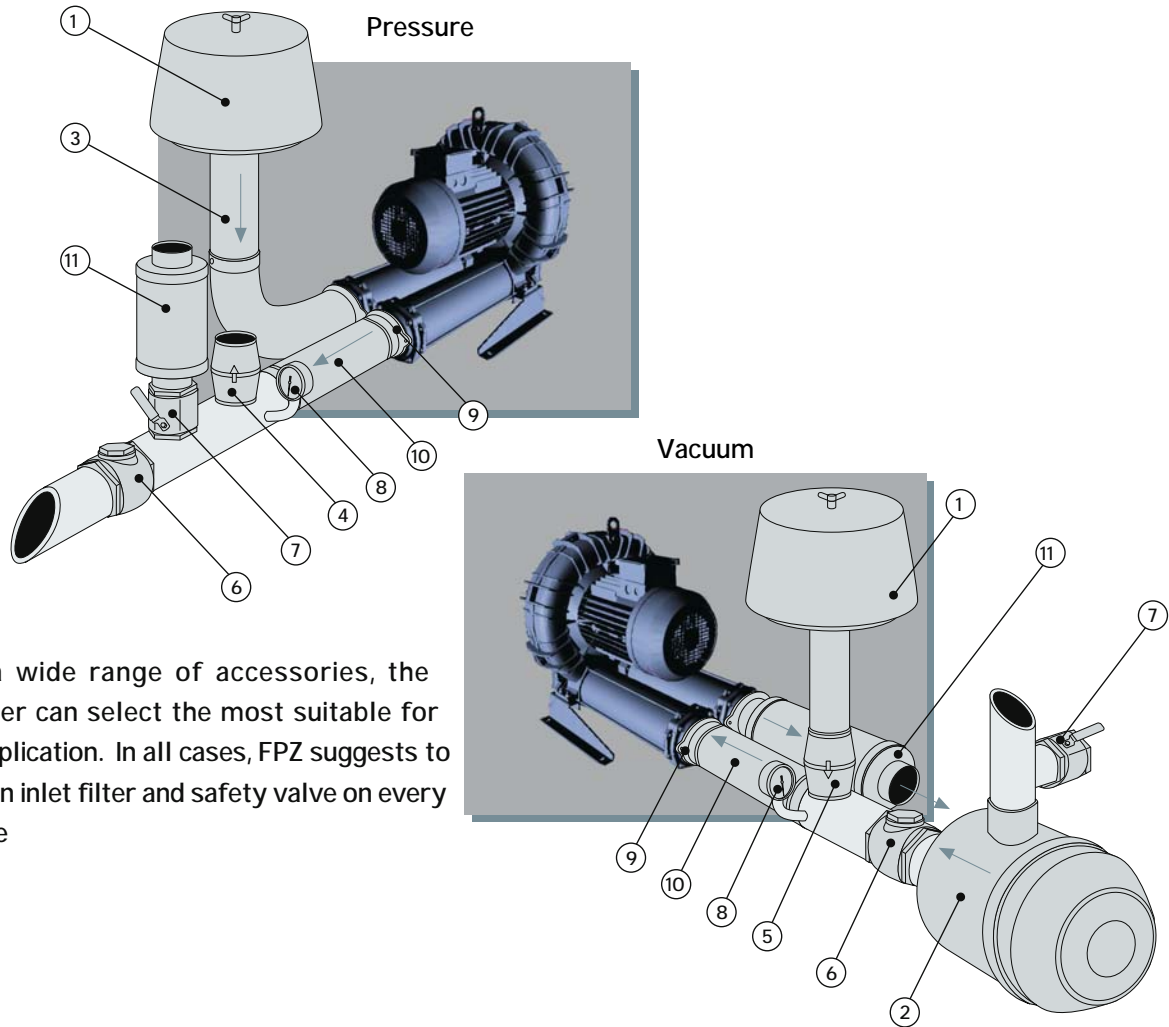

From a wide range of accessories, the customer can select the most suitable for their application. In all cases, FPZ suggests to install an inlet filter and safety valve on every machine

- 1 - Cartridge filter
- 2 - Inline filter
- 3 - Filter manifold
- 4 - Relief valve
- 5 - Vacuum valve
- 6 - Check valve
- 7 - Control valve
- 8 - Pressure / Vacuum gauge
- 9 - Sleeve
- 10 - Flexible hose
- 11 - Additional silencer

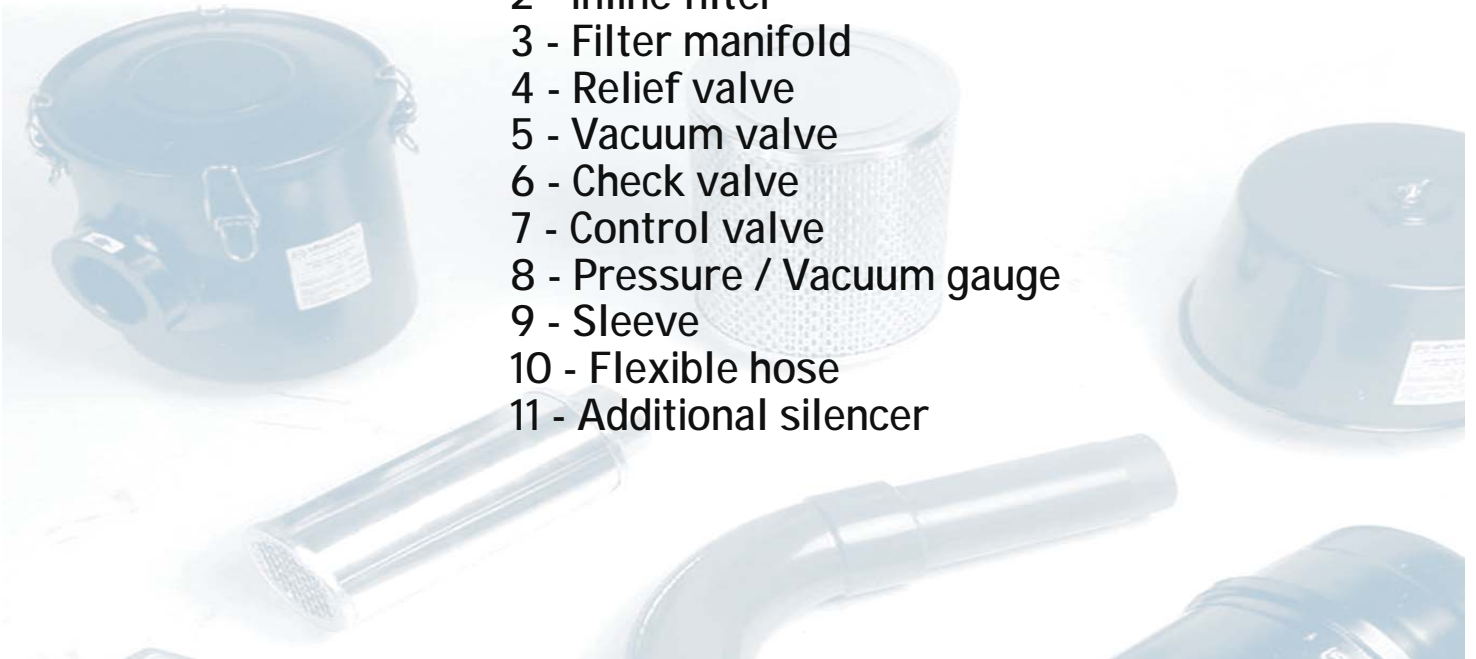

The following table is a guide to select the appropriate safety valve. The selections in the table are based on blowers operating at 60 Hz - for 50 hz applications refer to the safety valve data sheets. To select the appropriate safety valve, determine the blower model, horsepower, and whether it is to be used for vacuum or pressure service. If it is desirable to have the valve activate at lower pressures than the maximum rated pressure or vacuum of the blower, a different safety valve might be required (refer to safety valve data sheets). In some cases, two valves are required. FPZ valves are supplied uncalibrated. All safety valves include detailed instructions on how to calibrate and install the valve.

Single Stage Blowers			
Model	HP	Safety Valve Vacuum	Safety Valve Pressure
K03-MS	3/4	VRL6	VRL6
K04-MS	ALL	VRL6	VRL6
K05-MS	ALL	VRL6	VRL6
K06-MS	3	VRL6	VRL8
K06-MS	4	VRL6	VRL6
K06-MS	5 1/2	VRL6	VRL6
K06-MS	6 1/5	VRL6	VRL6
K07-MS	4	VRL8	VRL8
K07-MS	5 1/2	VRL6	VRL8
K07-MS	7 1/2	VRL6	VRL6
K07-MS	10	VRL6	VRL6
K08-MS	5.5	VRL8	VRL9
K08-MS	7 1/2	VRL8	VRL8
K08-MS	10	VRL6	VRL8
K08-MS	15	VRL6	VRL6
K09-MS	7 1/2	VRL9	VRL9
K09-MS	10	VRL8	VRL8
K09-MS	15	VRL6	VRL8
K09-MS	20	VRL6	VRL6
K10-MS	7 1/2	VRL9	VRL9
K10-MS	10	VRL9	VRL9
K10-MS	15	VRL8	VRL8
K10-MS	20	VRL6	VRL8
K10-MS	25	-	VRL6
K11-MS	10	VRL9	VRL9
K11-MS	15	VRL9	VRL9
K11-MS	20	VRL8	VRL8
K11-MS	25	VRL8	VRL8
K12-MS	15	VRL9	VRL9
K12-MS	20	VRL9	VRL9
K12-MS	25	VRL8	VRL8
K05-TS	ALL	VRL8	VRL8
K06-TS	5 1/2	VRL9	VRL9
K06-TS	7 1/2	VRL8	VRL8
K06-TS	10	VRL6	VRL8
K07-TS	7 1/2	VRL9	VRL9
K07-TS	10	VRL9	VRL9
K07-TS	15	VRL8	VRL8
K08-TS	7 1/2	N.A	N.A.
K08-TS	10	VRL9	(2) VRL9
K08-TS	15	VRL9	VRL9
K09-TS	15	(2) VRL9	(2) VRL9
K09-TS	20	VRL9	VRL9
K09-TS	25	VRL8	VRL9
K10-TS	15	(2) VRL9	(2) VRL9
K10-TS	20	(2) VRL9	(2) VRL9
K10-TS	25	VRL9	VRL9
K11-TS	25	(2) VRL9	(2) VRL9
K11-TS	30	(2) VRL9	(2) VRL9
K12-TS	30	(3) VRL9	(3) VRL9

Two Stage Blowers			
Model	HP	Safety Valve Vacuum	Safety Valve Pressure
15DH	ALL	VRL6	VRL6
R20-MD	ALL	VRL6	VRL6
30DH	ALL	VRL6	VRL6
40DH	ALL	VRL6	VRL6
K07-MD	3	VRL6	VRL6
K07-MD	4	VRL6	VRL6
K07-MD	5 1/2	VRL6	VRL6
K07-MD	7 1/2	VRL6	VRL6-HP
K08-MD	5 1/2	VRL6	VRL6
K08-MD	7 1/2	VRL6	VRL6
K08-MD	10	VRL6	VRL6
K08-MD	15	-	VRL6-HP
K09-MD	5 1/2	VRL8	VRL8
K09-MD	7 1/2	VRL6	VRL6
K09-MD	10	VRL6	VRL6
K09-MD	15	-	VRL6-HP
K10-MD	7 1/2	VRL8	VRL8
K10-MD	10	VRL6	VRL6
K10-MD	15	VRL6	VRL6
K10-MD	20	-	VRL6-HP
K11-MD	10	VRL8	VRL8
K11-MD	15	VRL6	VRL8
K11-MD	20	VRL6	VRL6-HP
K11-MD	25	-	VRL6-HP
K12-MD	15	VRL8	VRL8
K12-MD	20	VRL6	VRL6
K12-MD	25	-	VRL6-HP
K04-TD	2	VRL6	VRL6
K04-TD	3	VRL6	VRL6
K05-TD	3	VRL6	VRL6
K05-TD	4	VRL6	VRL6
K05-TD	5 1/2	VRL6	VRL6
K06-TD	5 1/2	VRL6	VRL8
K06-TD	7 1/2	VRL6	VRL6
K06-TD	10	VRL6	VRL6
K07-TD	7 1/2	VRL8	VRL8
K07-TD	10	VRL6	VRL6
K07-TD	15	VRL6	VRL6
K08-TD	7 1/2	VRL8	VRL8
K08-TD	10	VRL8	VRL8
K08-TD	15	VRL6	VRL6
K09-TD	20	VRL6	VRL8
K09-TD	25	VRL6	VRL6
K10-TD	15	VRL9	VRL9
K10-TD	20	VRL8	VRL8
K10-TD	25	VRL6	VRL8
K11-TD	20	VRL9	VRL9
K11-TD	25	VRL8	VRL8
K12-TD	25	VRL9	VRL9
K12-TD	30	VRL8	VRL8

Valve selections are based on 60 Hz operation and refer to air having a density equal to 0.075 lbs / cu. Ft and inlet temperature of 68 deg F. Data is subject to change without notice.

The VRL valves are designed to protect blowers and / or motors from over pressurization or excess vacuum. When there is over pressurization, the valve opens and discharges to the outside. When there is excess in vacuum, the valve opens and takes flow from outside.

The valves have been designed for low pressure / low vacuum, with minimal difference between the initial value at which the valve begins to open and its fully opened position. The valves are supplied with 2 different springs to maximize their efficiency.

These compact valves, made of aluminum alloy, are both easy to install and calibrate. The valves are designed to operate in a wide range of capacities. The VRL can be plumbed to divert excess primary flow through a secondary external outlet when working in pressure conditions or to pipe in a secondary flow when working in vacuum.

Maximum efficiency is achieved by keeping operating values (flow versus pressure or vacuum) within the operating range (shaded area on graph). Capacity refers to air having a density equal to 0.075 lbs./cu.ft .



VRL6

VRL8

VRL9

OPERATING RANGE

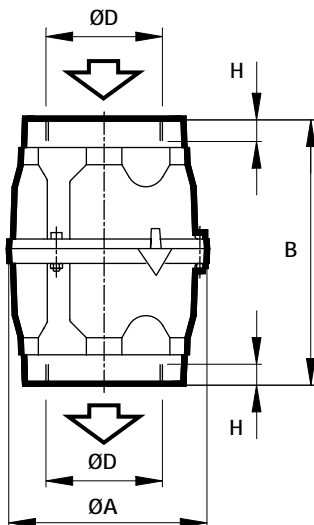
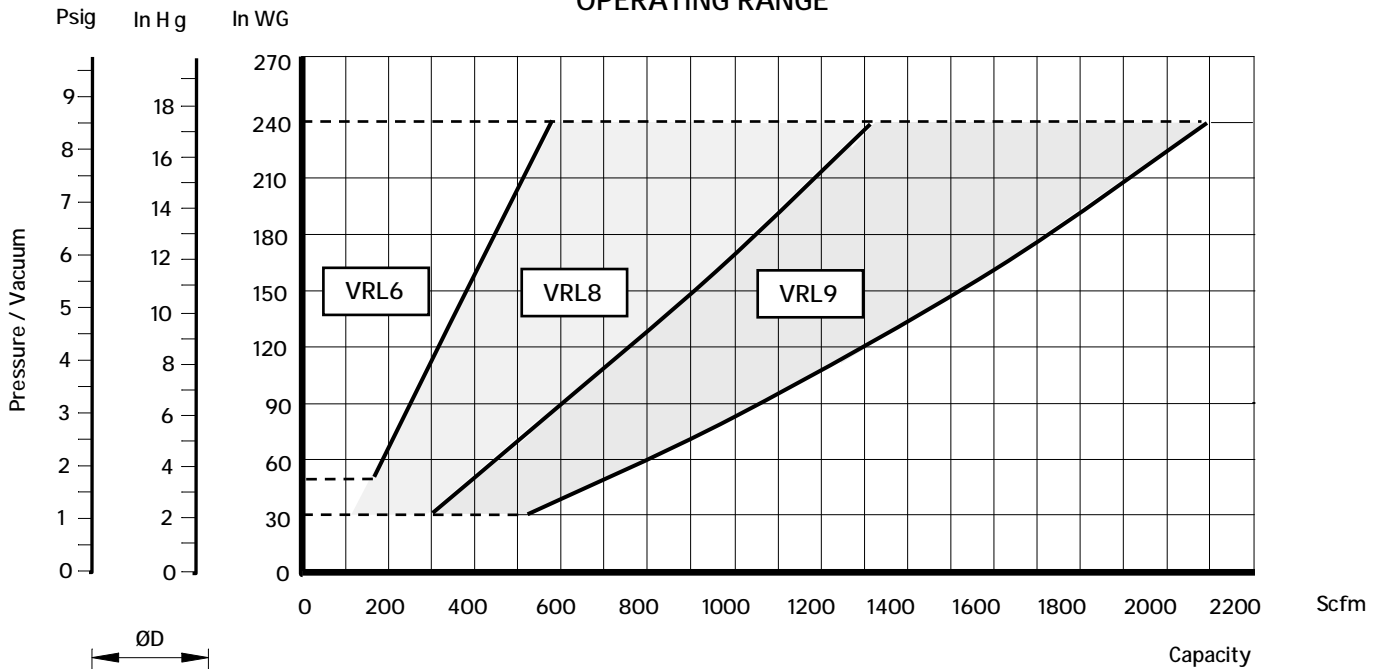

OVERALL DIMENSIONS

TYPE	ND	D	A	B	H	WEIGHT (Lbs)
VRL6	2"	2" NPT	4.02	6.90	0.47	1.9
VRL8	3"	3" NPT	5.31	7.48	0.59	4.2
VRL9	4"	4" NPT	6.30	8.11	0.71	5.7

- Dimensions in inches.
- Specifications subject to change without prior notice.

High Pressure Safety Valves

SS1401

The VRL H.P. valves are designed to protect blowers and / or motors from over pressurization or excess vacuum. When there is over pressurization, the valve opens and discharges to the outside. When there is excess in vacuum, the valve opens and takes flow from outside.

The valve have been designed for low pressure / low vacuum, with minimal difference between the initial value at which the valve begins to open and its fully-opened position.

These compact valves, made of aluminum alloy, are both easy to install and calibrate. The valves are designed to operate in a wide range of capacities. The VRL H.P. can be plumbed to divert excess primary flow through a secondary external outlet when working in pressure conditions or to pipe-in a secondary flow when working in vacuum.

Maximum efficiency is achieved by keeping operating values (flow versus pressure or vacuum) within the operating range (shaded area on graph). Capacity refers to air having a density equal to 0.075 lbs./cu.ft .



VRL6 - H.P.

VRL8 - H.P.

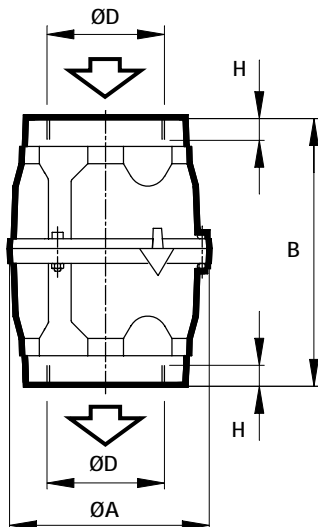
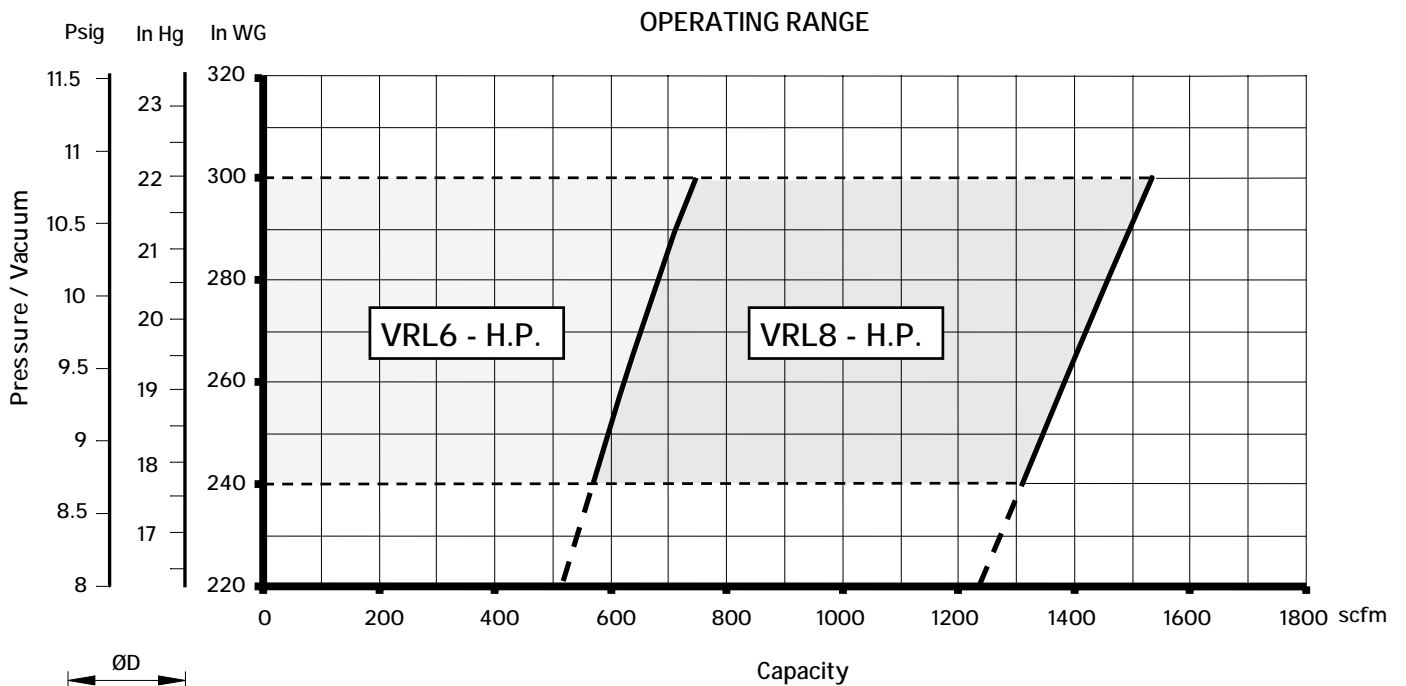

OVERALL DIMENSIONS

TYPE	ND	D	A	B	H	WEIGHT (Lbs)
VRL6 - H.P.	2"	2" NPT	3.94	6.57	0.47	2.1
VRL8 - H.P.	3"	3" NPT	5.31	7.48	0.59	4.2

- Dimensions in inches.
- Specifications subject to change without prior notice.

FPZ inline filters are typically used in vacuum applications to prevent debris from entering the blower. Inline filters consist of a metal housing with a metal cover retained by quick - change clamps for easy servicing of the element. Polyester elements are recommended for humid applications.

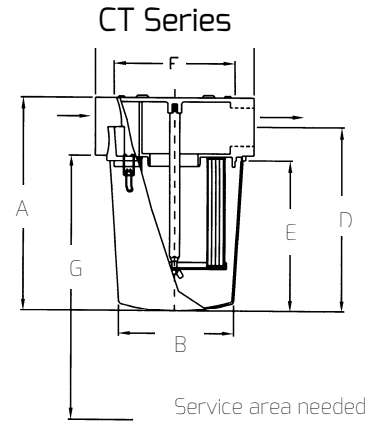
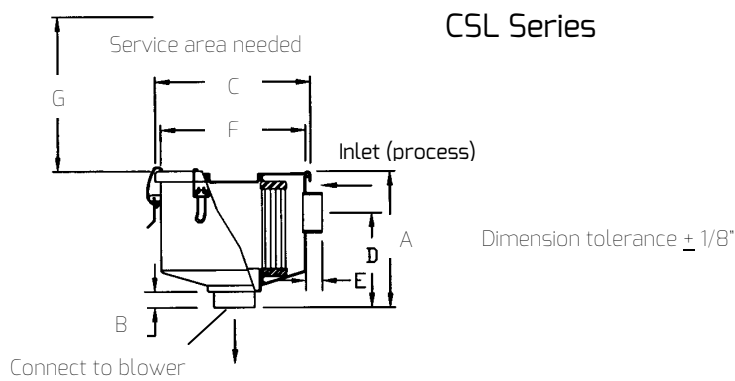

- ◆ Polyester: 99%+ removal efficiency standard to 5 micron
- ◆ Stainless steel torsion clips for durability
- ◆ Rugged all steel construction with Baked enamel finish
- ◆ Low pressure drop
- ◆ Positive sealing O-ring seal system
- ◆ Large dirt holding capacity and easy field cleaning, especially when mounted horizontally or inverted
- ◆ Fully-drawn one piece canister
- ◆ Filter change out differential: 10"-15" H₂O Over Initial Delta P

- ◆ Vacuum regulator & gauge available
- ◆ Various media available
- ◆ Epoxy coated housings
- ◆ Special connections
- ◆ Available in Stainless Steel
- ◆ Activated carbon prefilter to reduce odor
- ◆ Alternate Top-to-canister fastening system for low pressure or pulsating systems

Polyester Element	NPT	DIMENSIONS (Inches)							Used on Models	Approx Wt. Lbs
		A	B	C	D	E	F	G		
CSL-843-050HC	1/2"	4 3/8	9/16	5 7/8	2 1/2	9/16	5	3 1/4	10DL	3
CSL-843-075HC	3/4"	4 3/8	9/16	5 7/8	2 1/2	9/16	5	3 1/4	15DH	3
CSL-843-100HC	1"	4 3/8	3/4	5 7/8	2 1/2	3/4	5	3 1/4	06	3
CSL-843-125HC	1 1/4"	4 3/8	3/4	5 7/8	2 1/2	3/4	5	3 1/4	K03-MS, R20-MD	3
CSL-849-150HC	1 1/2"	6 1/2	3/4	7 5/16	4 1/2	3/4	6 13/16	5 1/4	K04-MS, K04-TD, 30DH, 40DH	5
CSL-851-200HC	2"	10 1/4	3/4	8 3/4	5	3/4	7 5/8	9 1/4	K05-MS, K06-MS, K05-TD, K06-TD, K07R-MD, K08R-MD	15
CT-235P-300C	3"	18 13/16	9 7/8	13 1/2	16 4/5	13 1/8	10	14	K05-TS, K06-TS, K07-MS, K08-MS, K07-TD, K08-TD	30
CT-235P-400C	4"	18 13/16	9 7/8	13 1/2	16 4/5	13 1/8	10	14	K09-MS, K10-MS, K09-MD, K10-MD, K11-MD, K12-MD, K09-TD, K10-TD	29
CSL-335P-400*	4"	27 1/8	3	14	18 1/2	3	12	15	K07-TS, K08-TS, K11-MS, K12-MS, K11-TD, K12-TD	30
CT-275P-500C	5"	18 1/4	16	19	14 3/8	9 7/8	14 3/4	20	K09-TS, K10-TS	50
CTD-375P-500C	5"	25 3/8	16	19	21 1/2	17	14 3/4	35	K11-TS, K12-TS	60

* Male x male npt connections
 Dimensions for reference only

FPZ inlet filters are used for pressure applications. The inlet filters combine filtration and sound attenuation into a compact package. Inlet filters consist of a filter cartridge enclosed by a carbon steel weather hood. Elements are easily serviceable by simply removing the weather hood.

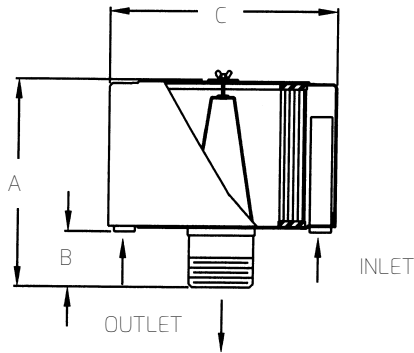

Dimension tolerance $\pm 1/8"$

FEATURES & SPECIFICATIONS

- Polyester: 99%+ removal efficiency standard to 5 micron
- Fully drawn weather hood - no welds to rust or vibrate apart
- Tubular silencing design - tube is positioned to maximize attenuation and air flow while minimizing pressure drop
- Durable carbon steel construction with baked enamel finish and powder coated weather hood
- Interchangeable elements: Polyester, Paper
- Low pressure drop center bracket and outlet pipe design
- Filter change out differential: 10"-15" H₂O Over Initial Delta P

TYPICAL NOISE ATTENUATION – FS SERIES

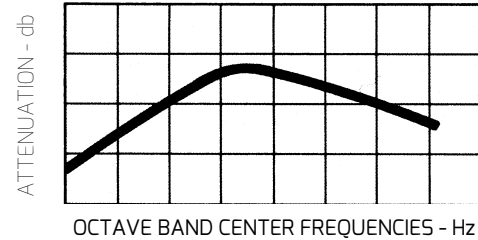

Noise attenuation may vary due to application

OPTIONS (Inquiries Encouraged)

- Various media available
- 1/8" & 1/4" tap holes
- Pressure Drop Indicator
- Available in Stainless Steel
- Epoxy coated housings
- Hot dipped galvanized housings
- Special connections, NPT

Polyester Element	NPT	Dimensions (Inches)			Used on Models	Approx Wt. Lbs
		A	B	C		
FS-15-050	1/2"	4	1 1/2	6	10DL	2
FS-15-075	3/4"	4	1 1/2	6	15DH	2
FS-15-100	1"	4	1 1/2	6	06	2
FS-19P-125	1 1/4"	6 5/8"	1 5/8"	6	K03-MS, R20-MD	3
FS-19P-150	1 1/2"	6 5/8"	1 5/8"	6	K04-MS, K04-TD, 30DH, 40DH	4
FS-31P-200	2"	7 1/4"	2 1/4"	10	K05-MS, K05-TD	8
FS-231P-200	2"	12 1/4"	2 1/4"	10	K06-MS, K06-TD, K07R-MD, K08R-MD	14
FS-231P-300	3"	13"	3"	10"	K07-MS, K05-TS, K07-TD	15
FS-235P-300	3"	13"	3"	16"	K08-MS, K06-TS, K08-TD	29
FS-235P-400	4"	14"	4"	16"	K09-MS, K10-MS, K09-MD, K10-MD, K11-MD, K12-MD, K09-TD, K10-TD	30
FS-245P-400	4"	14"	4"	16"	K07-TS, K08-TS, K11-MS, K12-MS, K11-TD, K12TD	31
FL10*	NA	14 3/8"	1 3/8"	16 3/16"	K09-TS, K10-TS, K11-TS, K12-TS,	18

*FL 10 utilizes 15 micron paper element and does not include tubular silencers

FEATURES

- ◆ Monitors Filter Continuously
- ◆ Easy Filter Maintenance
- ◆ Filter Element Life Maximized
- ◆ Downtime Reduced
- ◆ Graduated Restriction Readings

SPECIFICATIONS

The dirty filter indicator shows the amount of filter element restriction and how much life the element has left. This is a convenient and inexpensive solution to receiving the maximum usage from every element.

The yellow indicator in the filter monitor gauge drops as the dirt accumulates on the filter element. The element is ready for change out or servicing when the yellow indicator reaches the red zone. This allows you to determine the condition of the filter element even after the equipment has been shut down.

The element should be serviced or replaced at the maximum pressure drop of 10-15 inches of water. If the blower is operating at its maximum rated pressure, contact the factory for recommended setting.

GAUGE IN ACTION

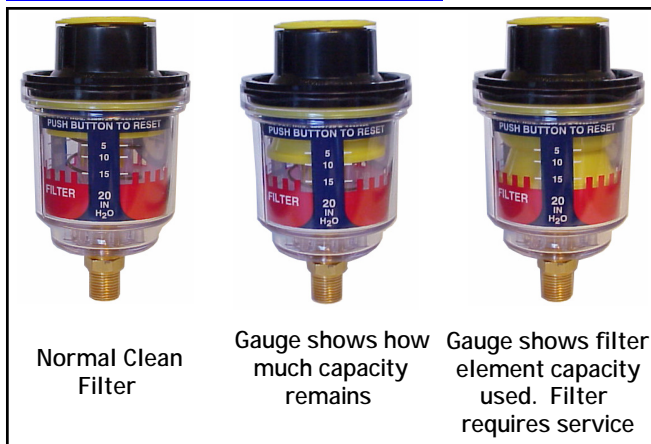

Part No: VG-020-013



Note: The monitor gauge has a 1/8" MPT connection. It is mounted either on the weatherhood or on the outlet pipe depending on the filter assembly. Used for pressure applications only.

Flow Converting Devices

 V6 / VS8
 SN 2616-2/1/1

This all aluminum device is simple in both design and operation. Change of flow direction is attained by an electronically or pneumatically activated diverter.

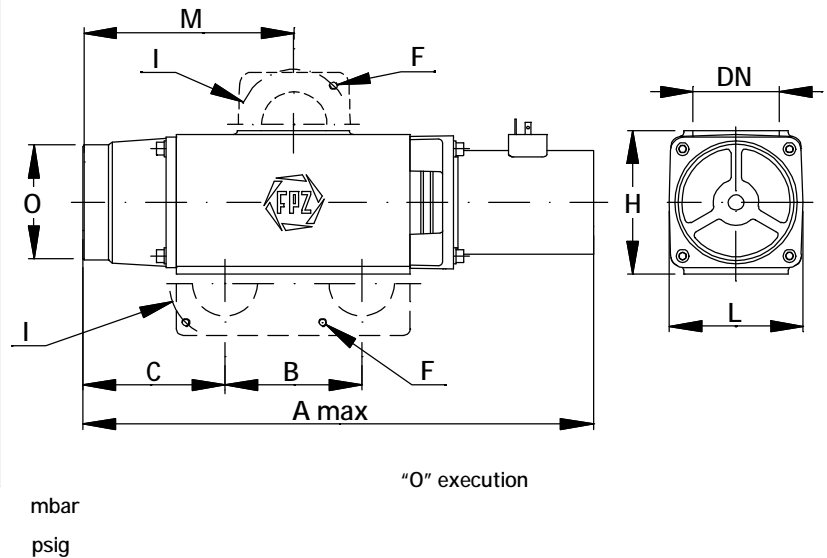
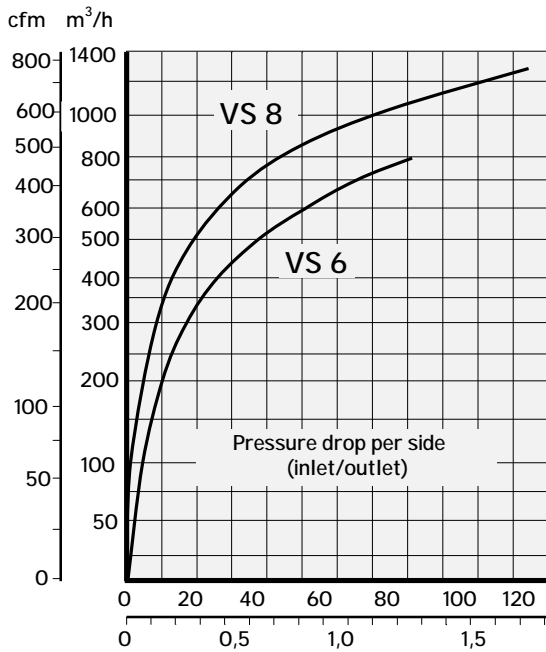

TYPE	DN	A		B	C	F	H	I	L	M	O
VS 6	2"	15.43 ⁽¹⁾	16.42 ⁽²⁾	4.13	4.29	M6	4.33	2 x int.3.35	3.94	6.38	3.46
VS 8	3"	19.09 ⁽¹⁾	20.08 ⁽²⁾	4.02	5.28	M6	6.3	4 x int.4.72	5.91	8.27	4.33

Overall dimensions refer to "O" execution without flanges

For the dimensions of the other executions pls see:

SI 1787 Executions O/P
 SI 1788 Executions Y/H/K with pneumatic control
 SI 2021 Executions Y/H/K with electrical control

(2) Electronically activated
 (3) Pneumatically activated

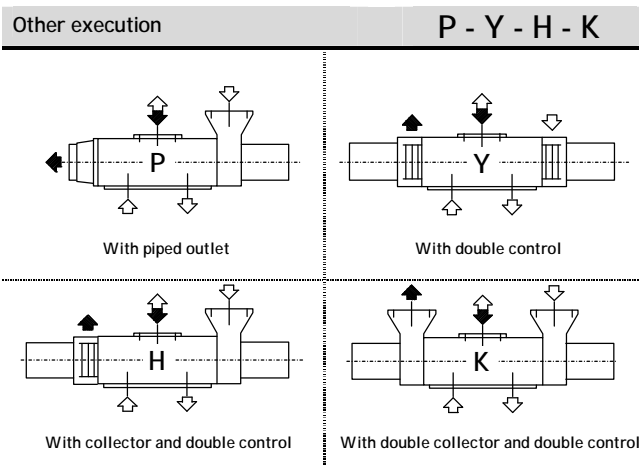

EXECUTION	
O/P	Y/H/K

Electrical control	
Thrust solenoid	
Working ratio	60% of cycle time
Max. cycle duration	5 min.
Max. activated time	3 min.
Power rating	56 W 120 W (3)
Standard supply voltages	V: 24 DC-110 AC-220 AC

(3) Only for VS6 (dp max. +350-350 mbar)

Pneumatic control	
Thrust air cylinder	Double effect
Max pressure	10 Bar
Air consumption	0.02 litres/cycle
Operating temperature	-5°C - +70 °C

Available connection

- TF threaded flange GAS (G 1 1/2", G 2", G 3");
- TF threaded flange NPT (NPT 1 1/2", NPT 2", NPT 3");
- See SU 0012.

Dimensions in inches. Tolerance on given values ±10 % - unbinding and can be changed without prior notice.

VK - FLANGE CONNECTOR FOR VRL VALVES

This VK flange accessory allows direct connection of the VRL relief valves to the cover of the SCL "K" model blowers; either in pressure or vacuum.

Note: VK flanges usable on K-MS and K-TS blowers in vacuum or pressure K-MD useable in vacuum only.

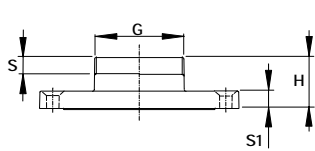

Fig. 1

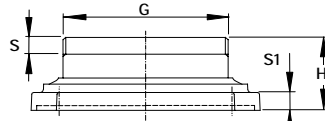
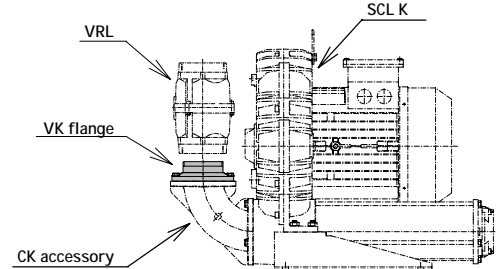
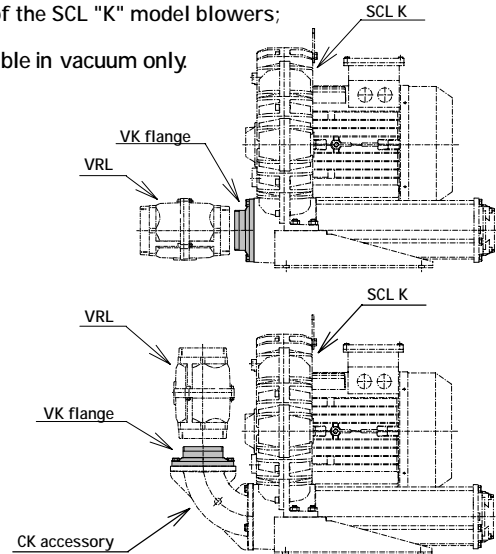
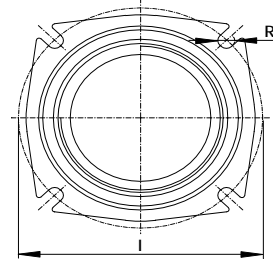
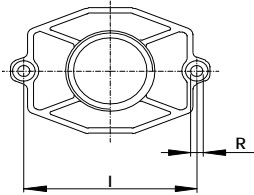

Fig. 2



Dimensions in Inches

Model	DN	G	H	I	R	S	S1	Fig.	Parts List
VK 5	1" 1/2	1" 1/2 NPT	1.18	3.62	0.26	0.59	0.39	1	SP 1552
VK 6	2"	2" NPT	1.97	4.33	0.33	0.75	0.39		SP 1553
VK 6A	2"	2" NPT	2.34	5.12	0.35	0.75	0.43	2	SP 1611
VK 8	3"	3" NPT	1.69	5.12	0.35	0.83	0.43		SP 1554
VK 9	4"	4" NPT	1.81	5.90	0.35	0.90	0.43		SP 1555

PK - FLANGED TUBE CONNECTOR FOR SCL K

The PK accessory allows connection of the "K" Series blowers directly to the process line without use of the intake or outlet manifolds.

CHARACTERISTICS

Flange in aluminium alloy with tube stub connection.

Supplied as a kit for mounting (with gasket and screws with wrench), please see the respective Parts List in table.

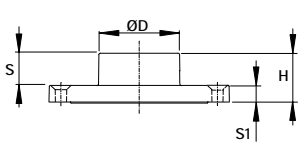

Fig. 1

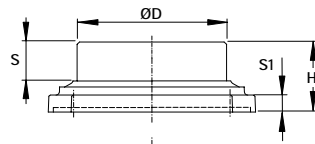

Fig. 1

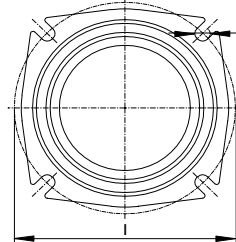

Fig. 2

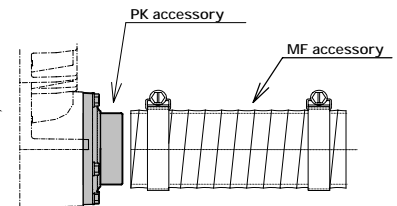
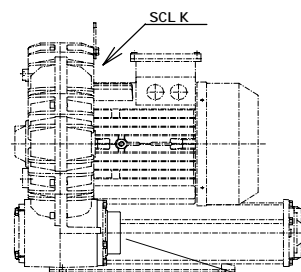

Fig. 2

Dimensions in Inches

Model	DN	D	H	I	R	S	S1	Fig.	Parts List
PK 5	1" 1/2	1.89	1.18	3.62	0.26	0.79	0.39	1	SP 1543
PK 6	2"	2.36	1.97	4.33	0.33	1.38	0.39		SP 1544
PK 6A	2"	2.36	2.34	5.12	0.35	1.38	0.43	2	SP 1609
PK 8	3"	3.46	1.69	5.12	0.35	0.94	0.43		SP 1545
PK 9	4"	4.48	1.81	5.90	0.35	1.06	0.43		SP 1546

Note: PK flanges usable on K-MS, K-TS, K-TD blowers in vacuum or pressure K-MD useable in vacuum only.

CA MANIFOLD FOR FA/FL FILTERS

90° wide radius PVC manifold with flanged connection and unthreaded tube end. Working temperature -20° to +40°C (-5° ÷ +105 °F).

Type	DN	A	B	D	S	I	R	Y	Fig.
CA4	1.25"	8.66	3.54	1.65	0.59	2.95	0.28	30°	1
CA4V	1.25"	8.66	3.54	1.65	0.59	2.52	0.28	-	2
CA5	1.5"	10.24	4.33	1.89	0.59	3.35	0.28	45°	1
CA5V	1.5"	10.24	4.33	1.89	0.59	2.95	0.28	-	2
CA6	2"	12.60	5.31	2.36	0.59	3.35	0.28	45°	1
CA6V	2"	12.60	5.31	2.36	0.59	3.35	0.28	-	2
CA8	3"	14.96	7.28	3.46	0.59	4.72	0.28	-	3
CA9	4"	15.75	9.25	4.45	0.79	5.91	0.35	-	
CA10	5"	17.72	11.81	5.51	0.79	8.27	0.71	-	

Dimensions in inches - unbinding and can be changed without prior notice.

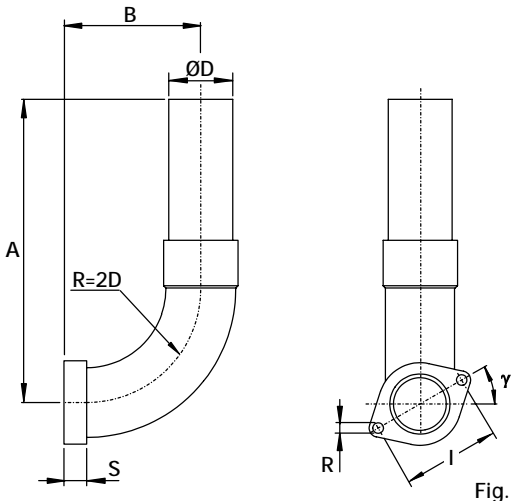

Fig. 1

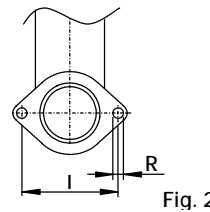

Fig. 2

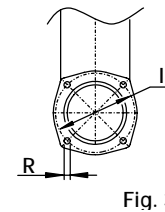

Fig. 3

CK MANIFOLD

90° aluminium manifold for "K" models supplied in a kit containing the gasket and bolts.

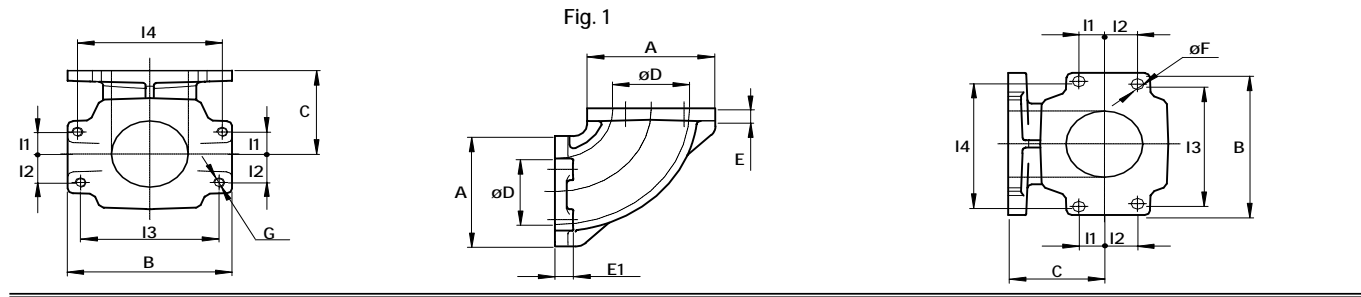

Fig. 1

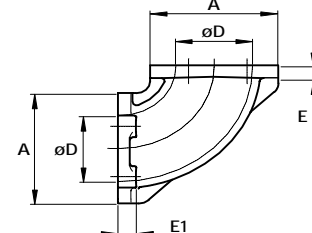
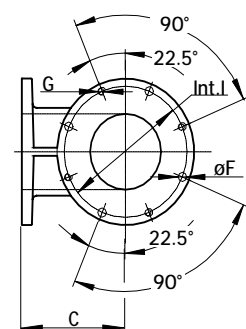
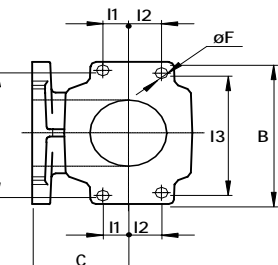
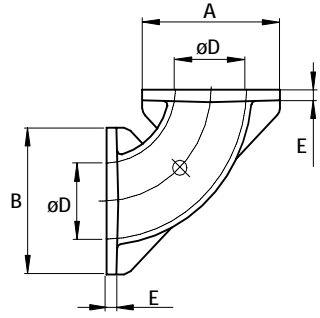
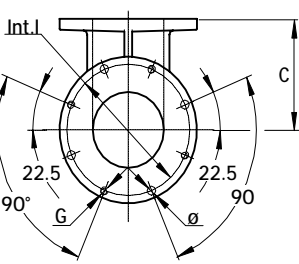

Fig. 2



Type	DN	A	B	C	D	E	E1	F	G	I	I1	I2	I3	I4	Fig.
CK4	1.25"	2.72	3.33	2.20	1.15	0.27	0.45	0.27	M6	-	0.57	0.57	2.76	2.76	1
CK5	1.5"	3.15	3.94	2.20	1.69	0.27	0.45	0.27	M6	-	0.69	0.69	3.35	3.35	
CK6	2"	3.62	4.65	2.72	2.16	0.31	0.51	0.35	M8	-	0.73	0.95	3.92	4.10	
CK8	3"	5.71	5.71	4.31	2.95	0.39	-	0.35	M8	5.12	-	-	-	-	2
CK9	4"	6.50	6.50	5.22	3.54	0.39	-	0.35	M8	5.90	-	-	-	-	
CK10	5"	8.66	8.66	7.56	5.04	0.39	-	0.35	M8	7.48	-	-	-	-	

Dimensions in inches - unbinding and can be changed without prior notice.

Gauges, Check Valves, Silencers, Enclosures

SS1310

Gauges

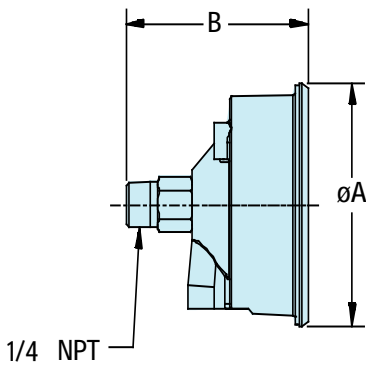

Gauges are important for monitoring the operating pressure or vacuum of the blower. Gauges should be positioned as close to the blower as possible.

Part number	Duty	Scale	A	B
VG25-60	Vacuum	0-60" H ₂ O	2.88	2.59
VG25-200	Vacuum	0-200" H ₂ O		
VG25-300	Vacuum	0-300" H ₂ O		
PG25-60	Pressure	0-60" H ₂ O		
PG25-200	Pressure	0-200" H ₂ O		
PG25-300	Pressure	0-300" H ₂ O		
PG20-15	Pressure	0-15 psi	2.25	1.9

Dimensions in inches. Tolerance on given values ± 10% - unbinding and can be changed without prior notice.

Check Valves

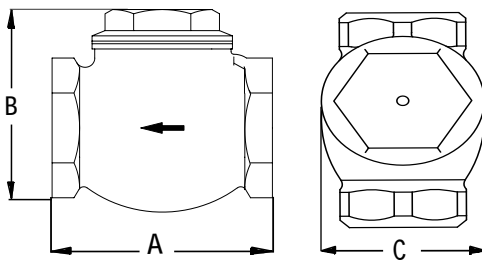

Swing check valves allow air to flow in one direction. These valves prevent backflow into the blower and are supplied in bronze or brass.

Part Number	NPT	A	B	C
CV075	0.75"	2.4		
CV10	1"	2.8	1.9	2.7
CV125	1.25"	3.2	2.2	3.2
CV15	1.5"	3.6	2.5	3.5
CV20	2"	4.3	3.1	4.2
CV30	3"	5.8	4.2	6.1
CV40	4"	6.9	5.5	7.1

Dimensions in inches. Tolerance on given values ± 10% - unbinding and can be changed without prior notice.

Silencers

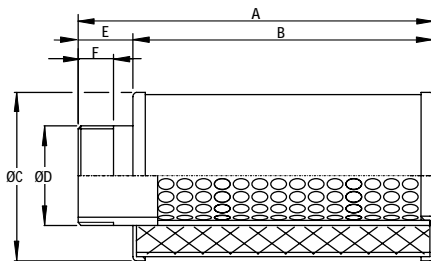

Silencers provide additional sound attenuation.

TYPE	D	A	B	C	E	F	lbs
SS 4	1" 1/4	7.5	5.5	2.8	2	0.6	0.8
SS 5	1" 1/2	7.9	6.7	3.1	1.2	0.8	1.1
SS 6	2"	9.1	7.9	3.5	1.2	0.8	1.3
SS 8	3"	19.1	15.7	6.0	3.3	0.8	4.8
SS 9	4"	18.3	16.9	6.7	1.1	0.8	9.9

Steel manufactured (apart from SI 9 / SS 9 - entirely in aluminium) with sound absorbing polyurethane element.

Dimensions in inches. Tolerance on given values ± 10% - unbinding and can be changed without prior notice.

Sound Enclosures

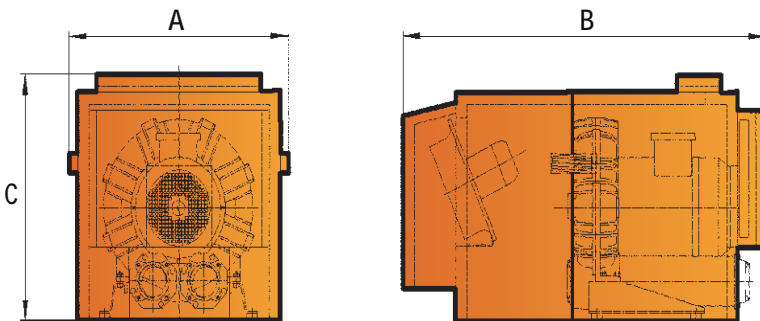

Part #	Used on models	A	B	C
IH1	SCL K03-MS	13.4	18.2	15.8
IH3	SCL K04-MS	14.3	19.7	16.5
IH5	SCL K05-6 MS + 30-40 DH	16.9	26.8	21.3
IH7	SCL K07-8 MS / MD	31.7	64.4	26
IH8	SCL K07-8 TD	31.7	64.4	26
IH9	SCL K07-8 TS	31.7	64.4	26
IH10	SCL K09-12 MS/MD	31.7	67.2	30
IH11	SCL K09-10 TD	31.7	67.2	30
IH12	SCL K11-TD	31.7	67.2	30
IH13	SCL K09-11 TS	31.7	67.2	31.5

Dimensions in inches - unbinding and can be changed without prior notice.

FLEXIBLE SLEEVE

Steel reinforced rubber - coated fibreglass flex tubing, including 2 adjustable hose clamps. Working temperature: -55 ÷ +176 °C (-67 ÷ +350 °F). Maximum working pressure: 3 bar (44 psi).

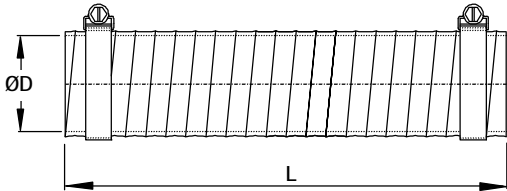

TIPO TYPE	DN	D	L
MF 1	1/2"	20	200
MF 2	3/4"	26	200
MF 3	1"	32	200
MF 4	1" 1/4	45	200
MF 5	1" 1/2	50	250
MF 6	2"	64	250
MF 8	3"	89	330
MF 9	4"	114	330
MF 10	5"	140	330

THREADED FLANGE

Threaded flange in aluminum alloy.

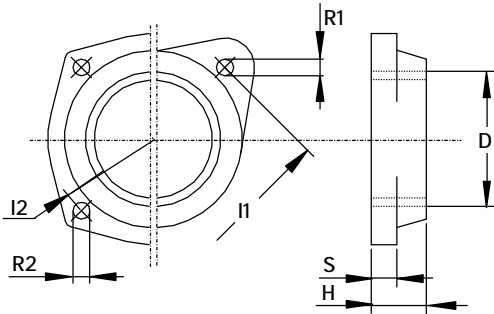

TIPO TYPE	D	H	I1	I2	R1	R2	S
TF 3	G 1"	18	55	-	6.5	-	10
TF 4	G 1" 1/4	18	75	-	6.5	-	10
TF 4V	G 1" 1/4	18	64	-	6.5	-	10
TF 5	G 1" 1/2	18	85	-	6.5	-	10
TF 5V	G 1" 1/2	18	75	-	6.5	-	10
TF 6	G 2"	18	85	-	6.5	-	10
TF 8	G 3"	25	-	120	-	6.5	13
TF 9	G 4"	25	-	150	-	9	13

SLEEVE

Aluminum alloy or steel flanged sleeve coupling.

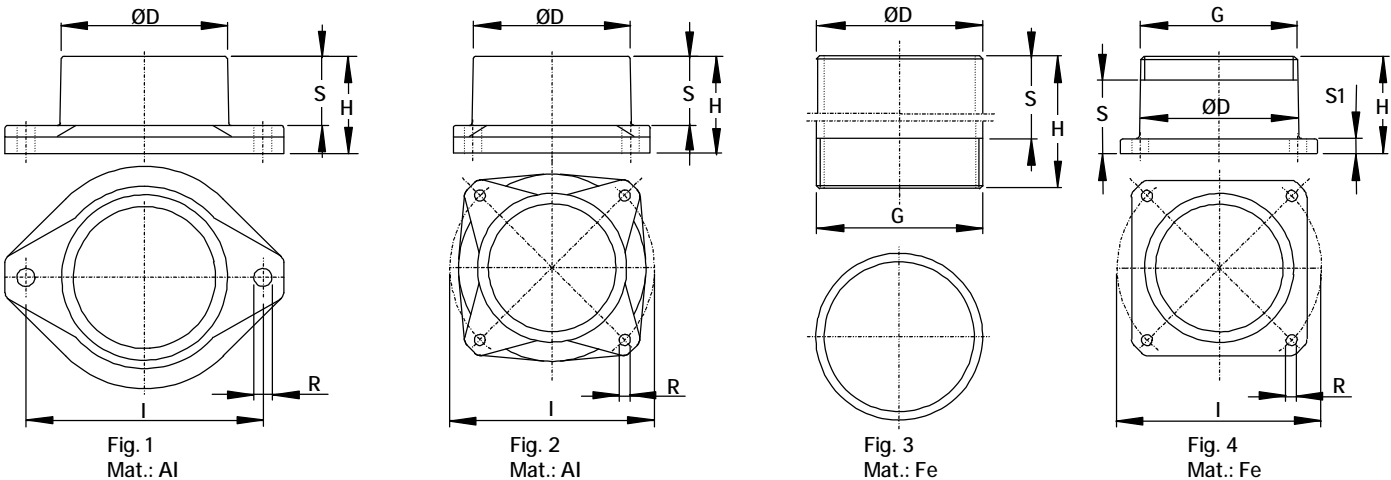

TIPO TYPE	DN	D	G	H	I	R	S	Fig.
MP 1	1/2"	21	G 1/2"	100	-	-	85	3
MP 2	3/4"	27	G 3/4"	100	-	-	85	
MP 3	1"	33	-	35	55	6.5	25	1
MP 4	1" 1/4	42	-	35	75	6.5	25	
MP 4V	1" 1/4	42	-	35	64	6.5	25	
MP 5	1" 1/2	48	-	35	85	6.5	25	

TIPO TYPE	DN	D	G	H	I	R	S	S1	Fig.
MP 5V	1" 1/2	48	-	35	75	6.5	25	-	1
MP 6	2"	60	-	35	85	6.5	25	-	
MP 8	3"	88	-	45	120	6.5	32	-	2
MP 9	4"	114	4" npt	100	-	-	80	-	3
MP 10	5"	140	5" npt	60	210	18	40	8	4

Dimensions in mm. Tolerance on given values ± 10% - unbinding and can be changed without prior notice.

SINGLE PHASE DUAL VOLTAGE

GENERAL SPECIFICATIONS:

- | | |
|-----------------------|-----------------------------------|
| 1- Type: | Single phase AC MOTOR - IEC 60034 |
| 2- Marks: | cURus, CE |
| 3- Poles: | 2 |
| 4- Frequency: | 60 Hz |
| 5- Insulation Class: | F |
| 6- Enclosure: | TEFC |
| 7- Protection: | IP 55 |
| 8- Thermal Protector: | KLIXON 140 °C |
| 9- Service Factor: | 1.0 |
| 10- Max. Ambient: | 40°C |
| 11- Duty: | Cont. |
| 12- Construction: | Aluminium frame |

POWER Hp	VOLTAGE V	SPEED min ⁻¹	FLA A	STARTING CURRENT A	POWER FACTOR cos φ	CAPACITOR μF
1/3	115-208/230	3330	3.5 / 1.7	12.3 / 6.0	0.97	16.0 - 400 V
1/2	115-208/230	3360	4.8 / 2.6	16.8 / 9.1	0.96	16.0 - 400 V
3/4	115-208/230	3450	9.8 / 4.9	46.1 / 23.0	0.95	20.0 - 400 V
1	115-208/230	3450	13.0 / 7.2	49.4 / 24.7	0.66	31.5 - 400 V
1 ½	115-208/230	3330	13.6 / 7.3	54.4 / 29.2	0.97	50.0 - 400 V
2	115-208/230	3440	24.0 / 12.0	79.2 / 39.6	0.90	70.0 - 400 V
3	115-208/230	3425	31.5 / 16.0	154.4 / 78.4	0.85	60.0 - 400 V

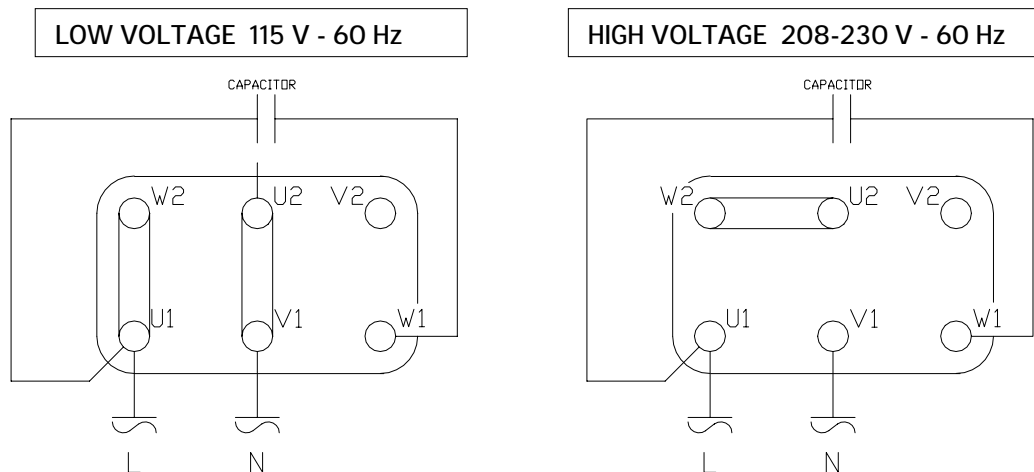

THERMAL PROTECTION NORMALLY CLOSED

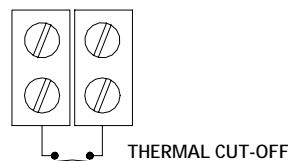

Specifications subject to change without notice. Alternate motor suppliers may be used.

THREE PHASE MOTOR

GENERAL SPECIFICATIONS:

- | | |
|--|--|
| <ol style="list-style-type: none"> 1. Type: 3-phase AC Motor IEC 60034 2. Marks: cURus, CE 3. Poles: 2 4. Insulation class: F 5. Frequency: 60 hz / 50 hz 6. Enclosure: TEFC | <ol style="list-style-type: none"> 7. Protection IP55 8. Thermal protector: Klixon 150° C 9. Service factor: 1.15 10. Max. Ambient 40° C 11. Duty: Continuous 12. Construction: aluminum frame |
|--|--|

POWER		SIZE	60 HZ			50 HZ			STARTING CURRENT RATIO*	CABLE ENTRY 1***	CABLE ENTRY 2
HP	KW		VOLTAGE	FLA 208 / 460	POWER FACTOR cos φ	VOLTAGE	FLA 230 / 400 (200 V)	POWER FACTOR cos φ			
0.33	0.25	63	208-230/460	1.5 / 0.7	0.75	230/400	1.4 / 0.8	0.70	3.9	M16	M20
0.5	0.37	63	208-230/460	2.3 / 1.0	0.79	230/400	2.1 / 1.2	0.73	3.6	M16	M20
0.75	0.55	71	208-230/460	2.7 / 1.2	0.85	230/400	2.6 / 1.5	0.78	3.8	M16	M20
1	0.75	80	208-230/460	3.3 / 1.5	0.84	230/400	3.5 / 2.0	0.78	5.0	M20	M25
1.5	1.1	80	208-230/460	5.0 / 2.3	0.86	230/400	4.5 / 2.6	0.82	5.6	M20	M25
2	1.5	90	208-230/460	6.3 / 2.9	0.82	230/400	6.1 / 3.5	0.82	5.0	M20	M25
3	2.2	90	208-230/460	9.0 / 4.1	0.87	230/400	8.5 / 4.9	0.81	7.1	M20	M25
4	3	90	208-230/460	11.2 / 5.9	0.80	230/400	11.8 / 6.8	0.80	7.0	M20	M25
		100	208-230/460	12.9 / 6.1	0.85	230/400	11.6 / 6.7	0.85	6.0	M25	M20
5.5	4	100	208-230/460	17.5 / 8.1	0.88	230/400	14.0 / 8.1	0.88	6.2	M25	M20
7.5	5.5	112	208-230/460	20.0 / 9.5	0.86	230/400	19.4 / 11.2	0.85	7.6	M25	M20
10	7.5	112	208-230/460	26.0 / 12.5	0.88	230/400	25.6 / 14.8	0.87	8.2	M25	M25
		132	208-230/460	26.5 / 15.3	0.87	230/400	37.5 / 21.7	0.84	6.9	M32	M32
15	11	132	208-230/460	40.0 / 21.7	0.84	230/400	37.5 / 21.7	0.84	6.9	M32	M32
20**	15	132**	208-230/460	54.0 / 26.0	0.86	200/400	(61.0) / 30.5	0.82	7.0	M32	M32
		160	208-230/460	54.0 / 29.8	0.85	230/400	51.6 / 29.8	0.85	8.1	M40	M40
25	18.5	160	208-230/460	63.0 / 34.8	0.87	230/400	60.0 / 34.8	0.87	8.5	M40	M40
30	22.0	160	208-230/460	72.0 / 41.5	0.87	230/400	72.0 / 41.5	0.87	8.4	M40	M40

* FLA x starting current ratio = starting current

** 9 leads motor applicable to 20 hp motors with 132 frame (MS / MD series)

*** Cable entry 1 includes cable gland

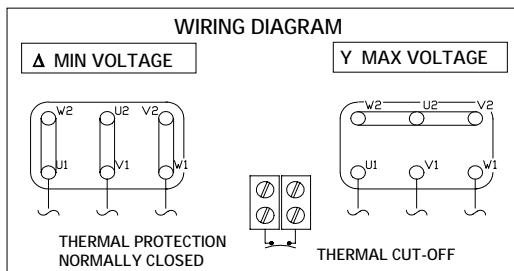

6 LEADS MOTORS.
208-230/460 V - 60 Hz
230/400 V - 50 Hz

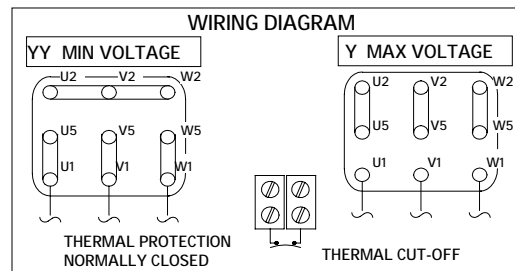

** 9 LEADS MOTOR . APPLICABLE TO 20Hp SIZE 132
208-230/460 V - 60 Hz
200/400 V - 50 Hz

Specifications subject to change without notice. Alternate motor suppliers may be used.



Pressure

Orifice Diameters - Inches

Pressure " H ₂ O	1/32	1/16	1/8	3/16	1/4	5/16	3/8	7/16	1/2	5/8	3/4	1	1-1/4	1-1/2	1-3/4	2.0	2-1/4	2-1/2	2-3/4	3
1	0.0	0.1	0.2	0.5	0.9	1.4	2.0	2.7	3.5	6	7.8	14	22	31	43	56	70	87	105	125
2	0.0	0.1	0.3	0.7	1.2	1.9	2.8	3.8	4.9	8	11	20	31	44	60	79	100	123	149	177
3	0.0	0.1	0.4	0.8	1.5	2.4	3.4	4.6	6.0	10	14	24	38	54	74	96	122	150	182	217
4	0.0	0.1	0.4	1.0	1.7	2.7	3.9	5.3	7.0	11	16	28	43	63	85	111	141	174	210	250
5	0.0	0.1	0.5	1.1	1.9	3.0	4.4	6.0	7.8	12	18	31	49	70	95	124	157	194	235	280
10	0.0	0.2	0.7	1.5	2.8	4.3	6.2	8.4	11.0	18	25	44	69	99	135	176	222	275	332	395
15	0.1	0.2	0.8	1.9	3.4	5.3	7.6	10.3	13.4	21	30	54	84	121	165	215	272	336	407	484
20	0.1	0.2	1.0	2.2	3.9	6.1	8.7	11.9	15.5	25	35	62	97	140	190	248	314	388	469	559
25	0.1	0.3	1.1	2.4	4.3	6.8	9.8	13.3	17.3	28	39	69	108	156	212	277	351	434	525	624
30	0.1	0.3	1.2	2.6	4.8	7.4	10.7	14.5	19.0	30	43	76	119	171	233	304	385	475	574	684
35	0.1	0.3	1.3	2.9	5.1	8.0	11.5	15.7	20.5	33	46	82	128	185	251	328	415	513	620	738
40	0.1	0.3	1.4	3.1	5.5	8.6	12.3	16.8	21.9	35	49	88	137	197	268	351	444	548	663	789
45	0.1	0.4	1.5	3.3	5.8	9.1	13.1	17.8	23.2	37	52	93	145	209	285	372	470	581	703	836
50	0.1	0.4	1.5	3.4	6.1	9.6	13.8	18.7	24.5	39	55	98	153	220	300	392	496	612	740	881
55	0.1	0.4	1.6	3.6	6.4	10.0	14.4	19.6	25.7	41	58	103	160	231	314	411	520	641	776	924
60	0.1	0.4	1.7	3.8	6.7	10.5	15.1	20.5	26.8	43	60	107	167	241	328	429	542	670	810	964
65	0.1	0.4	1.7	3.9	7.0	10.9	15.7	21.3	27.9	45	63	111	174	251	341	446	564	697	843	1003
70	0.1	0.5	1.8	4.1	7.2	11.3	16.3	22.1	28.9	46	65	116	181	260	354	463	585	723	874	1041
75	0.1	0.5	1.9	4.2	7.5	11.7	16.8	22.9	29.9	48	67	120	187	269	366	479	606	748	905	1077
80	0.1	0.5	1.9	4.3	7.7	12.1	17.4	23.6	30.9	50	70	124	193	278	378	494	625	772	934	1112
85	0.1	0.5	2.0	4.5	8.0	12.4	17.9	24.4	31.6	51	72	127	199	285	390	509	644	795	962	1145
90	0.1	0.5	2.0	4.6	8.2	12.8	18.4	25.1	32.7	53	74	131	204	294	401	524	663	818	990	1178
95	0.1	0.5	2.1	4.7	8.4	13.1	18.9	25.7	33.6	54	76	134	210	302	412	538	680	840	1016	1210
100	0.1	0.5	2.2	4.9	8.6	13.5	19.4	26.4	34.5	55	78	138	215	310	422	551	698	861	1042	1241
105	0.1	0.6	2.2	5.0	8.8	13.8	19.9	27.0	35.3	57	79	141	221	318	432	565	715	882	1068	1271
110	0.1	0.6	2.3	5.1	9.0	14.1	20.3	27.6	36.1	58	81	144	226	325	442	578	731	903	1092	1300

1 psi = 27.68" H₂O

discharge coefficient = 0.65

Air Temperature = 70 deg F

Airflow in CFM

Vacuum

Orifice Diameters - Inches

Vacuum " Hg	1/32	1/16	1/8	3/16	1/4	5/16	3/8	7/16	1/2	5/8	3/4	1	1-1/4	1-1/2	1-3/4	2.0	2-1/4	2-1/2	2-3/4	3
0.5	0.0	0.1	0.6	1.3	2.2	3.5	5.1	6.9	9	14	20	36	56	81	110	144	182	225	272	324
1	0.0	0.2	0.8	1.8	3.1	4.9	7.1	9.6	13	20	28	50	79	113	154	202	255	315	381	453
2	0.1	0.3	1.1	2.5	4.4	6.8	9.8	13.0	17	27	39	70	109	157	214	280	354	437	529	629
3	0.1	0.3	1.3	3.0	5.2	8.2	11.8	16.0	21	33	47	84	131	189	257	336	425	525	635	756
4	0.1	0.4	1.5	3.3	5.9	9.3	13.4	18.0	24	37	53	95	148	214	291	380	481	594	718	855
5	0.1	0.4	1.6	3.7	6.5	10.0	14.6	20.0	26	41	58	104	162	234	318	416	526	650	786	936
6	0.1	0.4	1.7	3.9	7.0	11.0	15.7	21.0	28	44	63	111	174	251	341	446	564	696	842	1002
7	0.1	0.5	1.8	4.1	7.3	11.0	16.5	22.0	29	46	66	118	184	264	360	470	595	735	889	1058
8	0.1	0.5	1.9	4.3	7.7	12.0	17.3	23.0	31	48	69	123	192	276	376	491	621	766	927	1104
9	0.1	0.5	2.0	4.5	7.9	12.0	17.8	24.0	32	50	71	127	198	285	388	507	642	792	959	1141
10	0.1	0.5	2.0	4.6	8.1	13.0	18.3	25.0	33	51	73	130	203	293	398	520	659	813	984	1171
11	0.1	0.5	2.1	4.7	8.3	13.0	18.7	25.0	33	52	76	133	207	298	406	530	671	829	1003	1193
12	0.1	0.5	2.1	4.7	8.4	13.0	18.9	26.0	34	52	76	134	210	302	412	538	680	840	1016	1210
13	0.1	0.5	2.1	4.8	8.5	13.0	19.1	26.0	34	53	76	135	212	305	415	542	686	847	1025	1219
14	0.1	0.5	2.1	4.8	8.5	13.0	19.1	26.0	34	53	76	136	212	306	416	544	688	849	1028	1223
15	0.1	0.5	2.1	4.8	8.5	13.0	19.1	26.0	34	53	76	136	212	306	416	544	688	849	1028	1223

1" HG = 13.6" H₂O

discharge coefficient = 0.65

Air Temperature = 70 deg F

Airflow in CFM